

24

CORTE
CUTTING
OUTILS COUPANTS
SCHNEIDWERKZEUG
ARCHETTI
CORTE
PE3KA



Los cortavarillas EGA Master están perfectamente diseñados y fabricados para cortar varillas cilíndricas, varillas de encofrador, mallas de alambre, cables, pernos, etc.

EGA Master bolt cutters are perfectly designed and manufactured for cutting rod, bolts, concrete from ties, cable and wires.

Les coupe-boulons EGA Master sont parfaitement conçus et fabriqués pour la coupe des tiges, des boulons, des câbles et des fils.

Regulación central / Central regulation / Réglage central



1 Sistema multiplicador de par de corte.

Cutting leverage multiplying system.

Accroissement de la coupe par le système multiplicateur.

2 El diseño especial reforzado de cabeza permite cortar varillas, pernos, etc. a muy poca distancia de la superficie desde la que sobresalen. El juego de cuchillas está fabricada en cromo-molibdeno, dándole una mayor resistencia y durabilidad gracias a la dureza 62 HRC.

Its strong & specially designed head permits cutting bolts and rods at a very small distance from the surface where they stick out from. Cutting-blades are made in Chrome-Molibdenum, providing a bigger resistance and durability due to their 62 HRC hardness.

Les mâchoires sont robustes et spécialement conçues pour couper au ras du mur. Les taillants sont en Chrome Molibdène d'une dureté de 62 HRC, ce qui confère une plus grande résistance et longévité aux mâchoires.

Regulación lateral / Lateral regulation / Régulation latérale



3 Gran capacidad de corte.

Great cutting capacity.

Capacité de coupe très importante.

4 Mangos ergonómicos y confortables.

Ergonomic and comfortable handles.

Manches ergonomiques et confortables.

Mangos forjados / Forged handles / Les bras forgés



■ CORTAVARILLAS / BOLT CUTTERS / COUPE-BOULONS / BOLZENSCHNEIDER / TAGLIABULLONI / CORTA VARÃO / АРМАТУРНЫЕ НОЖНИЦЫ

■ A

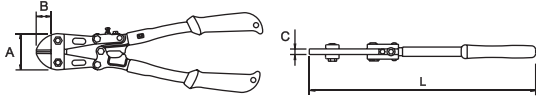

COD.	L (inch)	L (mm)	A (mm)	B (mm)	C (mm)	CAP 50 kg/mm ² 140 kg/mm ²	Kg		
62193	14	350	60	26	7,0	7-5	1,1	6	64096
62194	18	450	70	29	8,0	8-6	1,5	2	64097
62195	24	600	85	33	9,5	10-8	2,4		64098
62196	30	750	95	36	11	13-10	3,7		64099
62197	36	900	110	39	13	16-12	6,0	1	64100
62198	42	1050	120	43	14	19-14	8,0		64101
62199	48	1200	155	60	17	22-16	14		64700



■ B

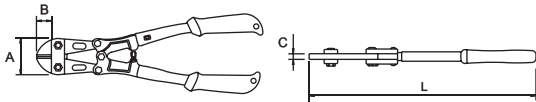

COD.	L (inch)	L (mm)	A (mm)	B (mm)	C (mm)	CAP 50 kg/mm ² 140 kg/mm ²	Kg		
62201	14	350	60	26	7,0	7-5	1,1	6	64056
62202	18	450	70	29	8,0	8-6	1,5	2	64057
62203	24	600	85	33	9,5	10-8	2,4		64058
62204	30	750	95	36	11	13-10	3,7		64059
62205	36	900	110	39	13	16-12	6,0	1	64060
62206	42	1050	120	43	14	19-14	8,0		64061



■ KIT 9 PCS.

COD.	PCS.	
62191	9	A

PCS.	COD.	
2	62193	14"-350 mm
	62194	18"-450 mm
	62195	24"-600 mm
	62196	30"-750 mm
1	62197	36"-900 mm



COD.	PCS.	
62190	9	B

PCS.	COD.	
2	62201	14"-350 mm
	62202	18"-450 mm
	62203	24"-600 mm
	62204	30"-750 mm
1	62205	36"-900 mm



■ MANGOS FORJADOS / FORGED HANDLES / MANCHES FORGÉS / STAHL GESCHMIEDET / MANICI FORGIHTI / CABOS FORJADOS / КОВАННЫЕ РУКОЯТКИ

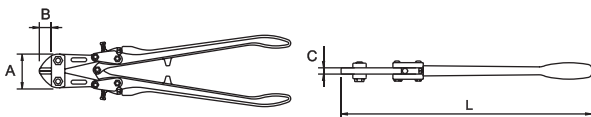

COD.	L (inch)	L (mm)	A (mm)	B (mm)	C (mm)	CAP 50 kg/mm ² 140 kg/mm ²	Kg		
62785	14	350	60	26	7	7-5	1,3		64453
62786	18	450	70	32	8	8-6	1,8		64454
62787	24	600	85	34	9,5	10-8	3,2	1	64455
62788	30	750	95	39	11	13-10	4,5		64456
62789	36	900	110	43	13	16-12	7,0		64457



KIT 9 PCS.

COD.		PCS.	
62192		9	
PCS.	COD.		
2	62785	14"-350 mm	
	62786	18"-450 mm	
	62787	24"-600 mm	
	62788	30"-750 mm	
1	62789	36"-900 mm	



CORTAVARILLAS FILO ANGULAR / ANGULAR EDGE BOLT CUTTERS / COUPE BOULON MACHOIRE COURBE / ECKRAND BOLZENSCHNEIDER / TAGLIABULLONI FILO ANGOLARE / CORTA VARÃO DE FIO ANGULAR / АРМАТУРНЫЕ НОЖНИЦЫ С РЕГУЛИРОВКОЙ

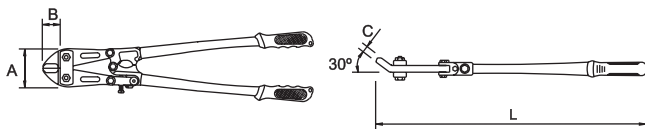

COD.	L (inch)	L (mm)	A (mm)	B (mm)	C (mm)	CAP 50 kg/mm ² 140 kg/mm ²	Kg			
62813	18	450	70	29	8	8-6	1,8			64689
62814	24	600	85	33	9,5	10-8	2,6	1		64690



CORTAVARILLAS / BOLT CUTTERS / COUPE-BOULONS / BOLZENSCHNEIDER / TAGLIABULLONI / CORTA VARÃO / АРМАТУРНЫЕ НОЖНИЦЫ

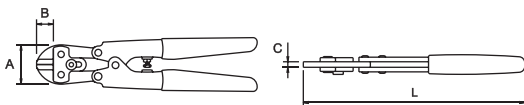

COD.	L (inch)	L (mm)	A (mm)	B (mm)	C (mm)	CAP 140 kg/mm ²	Kg			
62200	8	200	39	16	4,5	0,3	0,3	6		



CORTAVARILLAS DE MESA / BENCH TYPE BOLT CUTTER / COUPE-BOULONS SUR PLATEAU / TISCHBOLZENSCHNEIDER / TAGLIABULLONI DA BANCO / CORTA VARÃO DE BANCADA / ВЕРСТАЧНЫЕ АРМАТУРНЫЕ НОЖНИЦЫ

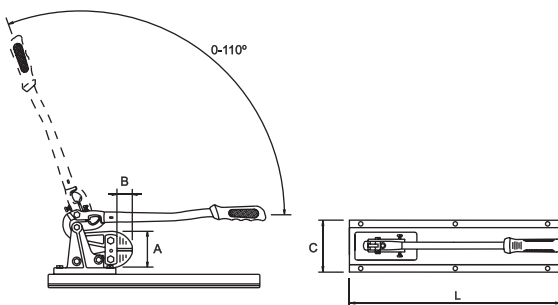

COD.	L (inch)	L (mm)	A (mm)	B (mm)	C (mm)	CAP 50 kg/mm ² 140 kg/mm ²	Kg			
62513	24	600	85	34	135	10-8	5,5	1		64334



CORTAVARILLAS BOCA PELICANO / PELICAN BOLT CUTTER / COUPE-BOULONS "BEC PELICAN" / BOLZENSCHNEIDER MAULSCHLÜSSEL / TAGLIABULLONI / TESOURA CORTA VARÃO BOCA PELICANO / АРМАТУРНЫЕ НОЖНИЦЫ «ПЕЛИКАН»

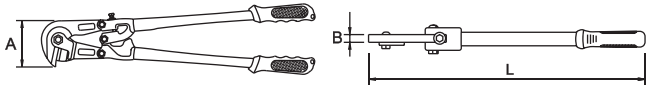

COD.	L (inch)	L (mm)	A (mm)	B (mm)	CAP 50 kg/mm ² 140 kg/mm ²	Kg		
62514	24	600	100	9,5	9-7	2,7	1	64335



CORTACABLES PARA CU-AL / CU-AL CABLE CUTTERS / COUPE CÂBLES POUR CU/AL / STAHLDRAHT SCHNEIDER FÜR CU/AL / TAGLIACAVI PER CU/AL / CORTACABOS PARA CU/AL / КАБЕЛЬНЫЕ НОЖНИЦЫ

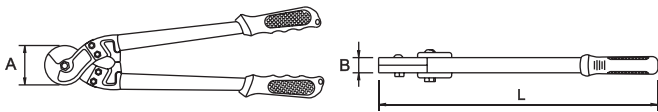

COD.	L (inch)	L (mm)	A (mm)	B (mm)	CAP 50 kg/mm ² 140 kg/mm ²	Kg		
62515	18	450	65	8,0	12	1,7	1	64331
62516	32	800	90	9,0	16	3,6	1	64332



CORTACABLES DE ACERO REFORZADO / H.D. WIRE ROPE CUTTER / COUPE CABLES EN ACIER RENFORCÉ / VERSTÄRKTER STAHLDRAHT BOLZENSCHNEIDER / CESCOIA PER CAVI / TESOURA CORTA CABOS DE AÇO REFORÇADO / УСИЛЕННЫЕ КАБЕЛЕРЕЗЫ

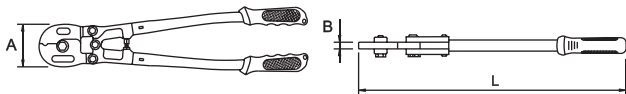

COD.	L (inch)	L (mm)	A (mm)	B (mm)	CAP 50 kg/mm ² 140 kg/mm ²	Kg		
62517	24	600	90	9,5	14-10	2,4	1	64328
62518	36	900	105	13	18-12	4,7	1	64329
62519	42	1050	120	15	22-13	8,0	1	64330

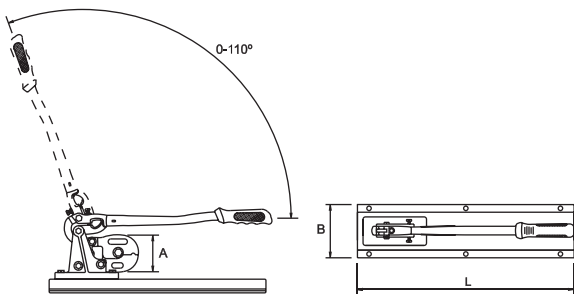

COD.	L (inch)	L (mm)	A (mm)	B (mm)	CAP 50 kg/mm ² 140 kg/mm ²	Kg		
62520	24	600	90	135	10-8	5,5	1	64328



TENAZA DE ENGASTAR / SWAGING TOOL / PINCE À SERTIR / KABELKLEMMZANGE / PINZA PER CAPICORDA / TURQUES DE ENGASTAR / ОПРЕССОВОЧНЫЙ ИНСТРУМЕНТ

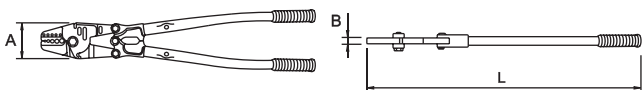

COD.	L (inch)	L (mm)	A (mm)	B (mm)	CAP mm	Kg		
62521	24	600	85	12	1,5-6	2,5	1	64333



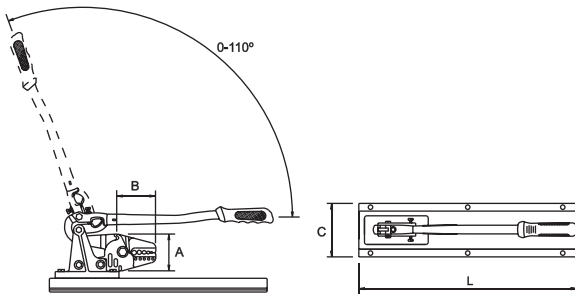

COD.	L (inch)	L (mm)	A (mm)	B (mm)	C (mm)	CAP mm	Kg		
62522	24	600	85	80	135	1,5-6	6,0	1	64333



ARCO DE SIERRA / HACK SAW / MONTURE DE SCIE À METAUX / METALLSÄGEBOGEN / ARCHETTI / ARCOS DE SERRA / HOЖOBKA

KRONOS

0° & 45° & 90°

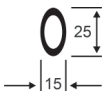

COD.	inch	mm	g	
63742	12	300	900	3



CARACTERÍSTICAS / FEATURES / CARACTÉRISTIQUES

Aluminio / Aluminum / Aluminium



APOLO II

0° & 45° & 90°

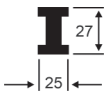

COD.	inch	mm	g	
63781	12	300	750	3

CARACTERÍSTICAS / FEATURES / CARACTÉRISTIQUES

Aluminio / Aluminum / Aluminium



HÉRCULES

0° & 45° & 90°

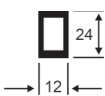

COD.	inch	mm	g	
63748	12	300	600	3

CARACTERÍSTICAS / FEATURES / CARACTÉRISTIQUES

Aluminio / Aluminum / Aluminium



■ TITÁN

■ 0° & 90°

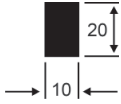

COD.				
63745	12	300	450	6



CARACTERÍSTICAS / FEATURES / CARACTÉRISTIQUES

Acero / Steel / Acier

■ MINIPROF

■ 90°

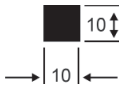

COD.				
63299	6	150	165	6



■ HOJAS DE SIERRA / HACK SAW BLADES / LAMES DE SCIÉS / METALLSÄGEBLÄTTER / LAME PER SEGHETTI / FOLHA DE SERRA / ПОЛОТНА ДЛЯ НОЖОВКИ

COD.	L (inch)			
64433	12	14	1,9	100
64434		18		
64435		24		
64436		32		



CARACTERÍSTICAS / FEATURES / CARACTÉRISTIQUES

Acero al carbono / Carbon steel / Acier en carbone

COD.	L (inch)			
64437	12	14	1,9	100
64438		18		
64439		24		
64440		32		



CARACTERÍSTICAS / FEATURES / CARACTÉRISTIQUES

HSS-Bimetal

Irrompible / Unbreakable / Indéchirable

COD.	L (inch)			
64441	12	14	1,9	100
64442		18		
64443		24		
64444		32		



CARACTERÍSTICAS / FEATURES / CARACTÉRISTIQUES

HSS-Bimetal (cobalt)

Irrompible / Unbreakable / Indéchirable

■ ACERO ESPECIAL TEMPLADO / HARDENED SPECIAL STEEL / ACIER TREMPÉ SPÉCIAL / GEHÄRTET SPEZIAL STAHL / ACCIAIO SPECIALE TEMPRATO / AÇO ESPECIAL TEMPERADO / СПЕЦИАЛЬНО ЗАКАЛЕННАЯ СТАЛЬ

COD.	L (inch)			
63771	6	24	30	6



TIJERAS / TIN SNIPS / CISAILLES / BLECHSCHERE / FORBICI / TESOURAS / НОЖНИЦЫ ДЛЯ ЖЕСТИ
TIJERAS ARTICULADAS / AVIATION TIN SNIPS / CISAILLE ARTICULÉE / BLECHSCHERE / CESCOIE A DOPPIA LEVA / TESOURAS ARTICULADAS / НОЖНИЦЫ ДЛЯ ЛИСТОВОГО МЕТАЛЛА

COD.	L (mm)	L (inch)	CAP mm	g		
62169	250	10	1,2	380	6	●

CARACTERÍSTICAS / FEATURES / CARACTÉRISTIQUES

Cr-V

Derecha / Right / Droite



COD.	L (mm)	L (inch)	CAP mm	g		
62170	250	10	1,2	380	6	●

CARACTERÍSTICAS / FEATURES / CARACTÉRISTIQUES

Cr-V

Recto / Straight / Droit



COD.	L (mm)	L (inch)	CAP mm	g		
62171	250	10	1,2	380	6	●

CARACTERÍSTICAS / FEATURES / CARACTÉRISTIQUES

Cr-V

Izquierda / Left / Gauche

TIJERAS ARTICULADAS REFORZADAS / REINFORCED AVIATION TIN SNIPS / CISAILLE ARTICULÉE RENFORCÉE / VERSTÄRKTE BLECHSCHERE / CESCOIE A DOPPIA LEVA RINFORZATA / TESOURAS ARTICULADAS REFORÇADAS / УСИЛЕННЫЕ НОЖНИЦЫ ДЛЯ ЛИСТОВОГО МЕТАЛЛА

COD.	L (mm)	L (inch)	CAP mm	g		
62188	250	10	1,2	470	6	●

CARACTERÍSTICAS / FEATURES / CARACTÉRISTIQUES

Cr-V

Derecha / Right / Droite



COD.	L (mm)	L (inch)	CAP mm	g		
62189	250	10	1,2	470	6	●

CARACTERÍSTICAS / FEATURES / CARACTÉRISTIQUES

Cr-V

Izquierda / Left / Gauche

TIJERAS PARA CHAPA / TIN SNIPS / CISAILLES À TOLE / BLECHSCHEREN / CESCOIE PER LAMIERA / TESOURA PARA CHAPA / НОЖНИЦЫ ДЛЯ ЛИСТОВОГО МЕТАЛЛА





COD.	L (inch)	CAP mm	g		
62232	8	0,5	350		
62159	10	1	550	6	●
62233	12	1,2	700	4	-
62234	14		900		

BRITISH TYPE

COD.	L (inch)	CAP mm	g		
62268	10	1	490		
62270	14	1,2	900	6	●



CORTADORES / CUTTERS / CUTTERS / MESSER / CUTTERS / CORTADORES / РЕЗАКИ





COD.					
69501	0,6	110	12	●	64005
69502	0,6	35	12	●	64005
63874	0,5	135	10	●	63868



CARACTERÍSTICAS / FEATURES / CARACTÉRISTIQUES

Carga automática con 7 cuchillas / Automatic load with 7 blades / Charge automatique avec 7 lames

CORTADORES DE SEGURIDAD CON CUCHILLA AUTO-RETRACTIL / SAFETY CUTTER WITH AUTO-RETRACTABLE BLADE / CUTTER DE SÉCURITÉ AVEC LAME AUTO-RÉTRACTABLE / SICHERHEITSMESSER MIT AUTOMATISCH EINZIEHBARER KLINGE / CUTTERS DI SICUREZZA CON LAMA AUTOMATICA - RETRAIBILE / CORTADORES DE SEGURANÇA COM LÂMINA AUTO-RETRACTIL / БЕЗОПАСНЫЙ НОЖ С АВТОМАТИЧЕСКИ УБИРАЕМЫМ ЛЕЗВИЕМ

COD.					
63876	0,6	140	12	●	64005
63877	0,6	130	12	●	64005
63878	0,6	40	12	●	64005



CUCHILLA TRAPEZOIDAL / TRAPEZOIDAL BLADE / LAME TRAPEZOÏDALE / TRAPEZKLINGE / LAMA TRAPEZIOIDALE / LÂMINA TRAPEZOIDAL / ТРАПЕЦЕВИДНОЕ ЛЕЗВИЕ

COD.	L x W x H (mm)	
64005	60 x 19 x 0,6	5





CUCHILLA TIPO GANCHO / HOOK TYPE BLADE / LAME CROCHET / HAKENKLINGE / LAMA TIPO GANCIO / LÂMINA TIPO GANCHO / ЛЕЗВИЕ КРЮЧКОВОГО ТИПА

COD.	L x W x H (mm)	
63869	50 x 19 x 0,65	5



CUCHILLA / BLADE / LAME / KLINGE / LAMA / LÂMINA / ЛЕЗВИЕ

COD.	L x W x H (mm)		
63868	108 x 15 x 0,5	40	5



EXPOSITOR / DISPLAY / PRESENTOIR / STÄNDER / ESPOSITORE / DISPLAY STAND / СТЕНДЫ

42 PCS.



COD.	PCS.
55569	42
PCS.	COD.
16	63877
	63878

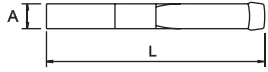

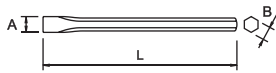

CINCEL CHAPISTA / EXTRA FLAT COLD CHISEL / BURIN DE CARROSSIER / SCHLITZMEISSEL / SCALPELLO A FREDDO PIATTO / ESCOPRO FINO / СВЕРХ ПЛОСКОЕ ЗУБИЛО

COD.	L (mm)	A (mm)			
63472	204	27	240	6	•

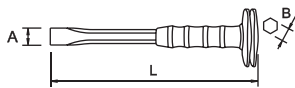

CINCEL / FLAT CHISEL / CISEAUX DE MAÇON / FLACHMEISSEL / SCALPELLI PER MURATORI / ESCOPRO / ПЛОСКОЕ ЗУБИЛО

COD.	L (mm)	A (mm)	B (mm)		
63309	200	23		300	
63311		24	16	480	
63315	300	25		600	
63316	350	26	18	700	6
63320	400	27		950	
63321	500	28	20	1200	



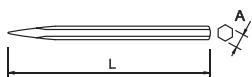

COD.	L (mm)	A (mm)	B (mm)		
63326	200	23		450	
63328		24	16	650	
63332	300	25		750	
63333	350	26	18	850	6
63337	400	27		1100	
63338	500	28	20	1350	

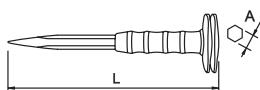

PUNTERO / POINTED CHISEL / BROCHE / SPITZMEISSEL / SCALPELLI PER MURATORI / PONTEIRO / КОНУСНОЕ ЗУБИЛО



COD.	L (mm)	A (mm)		
63339	200		300	
63340	250	16	390	
63341	300		480	
63343	350		700	6
63344	400	18	800	
63345			950	
63346	500	20	1200	



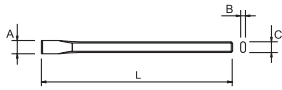

COD.	L (mm)	A (mm)		
63347	200		450	
63348	250	16	550	
63349	300		650	
63351	350		850	6
63352	400	18	950	
63353			1100	
63354	500	20	1350	



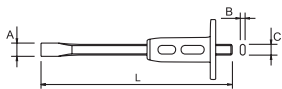

■ CINCEL MECÁNICO / FLAT COLD CHISEL / BURIN MÉCANICIEN / FLACHMEIBEL / SCALPELLO PER MECCANICO / ESCOPRO MECÂNICO / ПЛОСКОЕ ЗУБИЛО

COD.	L (mm)	A (mm)	B (mm)	C (mm)		
62847	100	12	7,0	11	65	
62848	125	15	9,0	14	115	12
62849	150	18	11	17	220	
62850	200	21			280	
62851		24	12	20	290	
62852	225	25			300	
62853	250	28			320	
62854		26		23	460	6
62855	300	29	13		480	
62856	400	30		26	500	
62857	500				550	
62858						



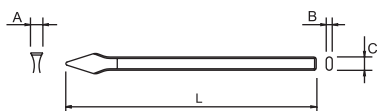

COD.	L (mm)	A (mm)	B (mm)	C (mm)		
62862	200	21			330	
62863		24	12	20	340	
62864	225	25			350	
62865	250	28			370	6
62866		26	13	23	500	
62867	300	29			550	
62868	500	30		26	600	
62870						

■ BURIL PLANO / CROSSCUT CHISEL / BÉDANE PLATE / KREUZSCHNITT MEIBEL / BULINO PIATTO / BURIL PLANO / ЗУБИЛО ДЛЯ ВЫРУБКИ

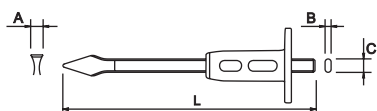
COD.	L (mm)	A (mm)	B (mm)	C (mm)		
62871	125	5,0	9,0	14	90	
62872	150	6,0	10	16	150	
62873	175	7,0	11	17	240	
62874	200	8,0	12	20	280	6
62875	250	9,0	13	23	300	
62876	300				310	



COD.	L (mm)	A (mm)	B (mm)	C (mm)		
62880	200	8,0	12	20	330	
62881	250	9,0	13	23	350	6
62882	300				360	



CINCEL PARA LADRILLOS / BOLSTER CHISEL / CISEAUX À BRIQUES / FUGENMEISSEL / SCALPELLI DA PIASTRELLISTA / ESCOPRO PARA LADRILHOS / ЛОПАТОЧНОЕ ЗУБИЛО

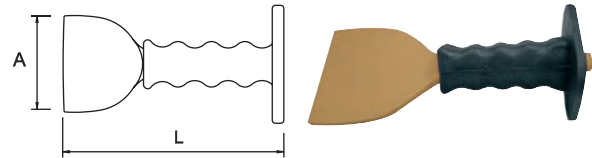
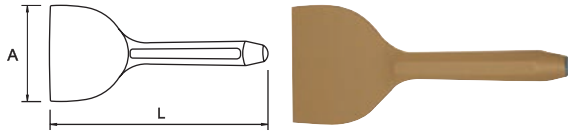

COD.	L (mm)	A (mm)	g	Icon
63181	220	60	450	6
63182	240	75	700	
63191	240	100	750	

COD.	L (mm)	A (mm)	g	Icon
63183	220	60	410	5
63184	240	75	750	
63192	240	100	800	

SETS

CINCELES, BOTADORES Y GRANETES / CHISELS AND PUNCHES / BURINS, CHASSE-GOUPILLES ET CHASSE-CLOUS / MEIBEL UND DURCHSCHLÄGE / SCALPELLI E PUNZONI / ESCOPROS, SACA-TROÇOS E PUNÇÕES / ЗУБИЛА И ПРОБОЙНИКИ

6 PCS.

COD.	PCS.	g
69953	6	700

PCS.	COD.	Descripción / Description / Description	Dimensions
1	62847	Cinzel mecánico / Flat cold chisel	12 x 11 x 100 mm
	62848	Cinzel mecánico / Flat cold chisel	15 x 14 x 125 mm
	63398	Botador cilíndrico / Pin punch	6 x 10 x 150 mm
	63396	Botador cilíndrico / Pin punch	4 x 8 x 150 mm
	63416	Botador cónico / Taper punch	3 x 10 x 125 mm
	63436	Granete / Center punch	3 x 8 x 100 mm



COD.	PCS.	g
69954	6	700

PCS.	COD.	Descripción / Description / Description	Dimensions
1	62847	Cinzel mecánico / Flat cold chisel	12 x 11 x 100 mm
	62848	Cinzel mecánico / Flat cold chisel	15 x 14 x 125 mm
	62871	Buril plano / Crosscut chisel	5 x 14 x 125 mm
	63396	Botador cilíndrico / Pin punch	4 x 8 x 150 mm
	63416	Botador cónico / Taper punch	3 x 10 x 125 mm
	63436	Granete / Center punch	3 x 8 x 100 mm



CINCELES / CHISELS / BURINS / MEISELN / SCALPELLI / ESCOPROS / ЗУБИЛА

50 PCS.

COD.	PCS.	Kg
55566	50	20

PCS.	COD.	Descripción / Description / Description	Dimensions
5	62849	Cinzel mecánico / Flat cold chisel	18 x 17 x 150 mm
	62850	Cinzel mecánico / Flat cold chisel	21 x 20 x 200 mm
	62854	Cinzel mecánico / Flat cold chisel	28 x 23 x 250 mm
	62857	Cinzel mecánico / Flat cold chisel	30 x 26 x 400 mm
	62873	Buril plano / Crosscut chisel	7 x 17 x 175 mm
5	62874	Buril plano / Crosscut chisel	8 x 20 x 200 mm
	62875	Buril plano / Crosscut chisel	9 x 23 x 250 mm
	63340	Puntero / Point chisel	16 x 250 mm
	63341	Puntero / Point chisel	16 x 300 mm
	63344	Puntero / Point chisel	18 x 400 mm



■ HACHAS / AXES / HACHES / ÄXTE / ASCIA / MACHADOS / ТОПОРЫ

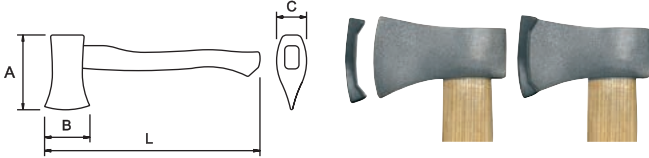



COD.	L (mm)	A (mm)	B (mm)	C (mm)		
67232	450	145	100	22	0,8	6

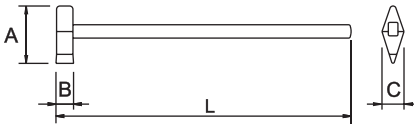

■ MAZA CUÑA / WEDGE HAMMER / MERLIN / SPALTHAMMER / MARTELLO A CUNEO / MALHOS / ТОПОР КОЛУХ





COD.	L (mm)	A (mm)	B (mm)	C (mm)		
67239	900	210	90	50	2,5	6

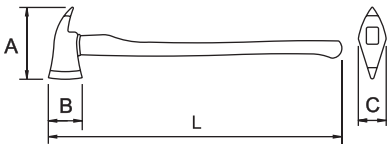

■ HACHA BOMBERO / FIREMAN TYPE AXE / HACHE POUR POMPIERS / FEUERWEHRAXT / ASCIA TIPO PER POMPIERI / MACHADO DE BOMBEIRO / ТОПОР ПОЖАРНОГО ТИПА





COD.	L (mm)	A (mm)	B (mm)	C (mm)		
67240	910	250	105	32	2,3	6

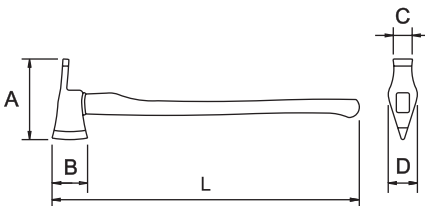

■ HACHA AZADA / HOE AXE / HACHE HOUÉ / WIEDEHOPFHACKE / ASCIA A ZAPPA / MACHADO ENXADA / ТОПОР МОТЫГА



COD.	L (mm)	A (mm)	B (mm)	C (mm)	D (mm)		
67243	910	310	110	80	29	3,2	6



CARACTERÍSTICAS / FEATURES / CARACTÉRISTIQUES

Fibra de vidrio / Fiberglass / Fibre de verre

SIERRAS DE CORONA BIMETAL / BI-METAL HOLE SAWS / SCIES CLOCHES BI-MÉTAL / BIMETALL LOCHSÄGE / SEGHE A TAZZA BI-METAL / SERRAS CRANEANAS BI-METÁLICAS / БИМЕТАЛЛИЧЕСКИЕ КОРОНКИ

HSS BI-METAL

4/6 TPI

COD.	O.D. mm	O.D. inch	H (mm)	R.P.M. Acero dulce /	R.P.M. Inox	R.P.M. Fundición /	R.P.M. Aluminio /	R.P.M. Latón /	R.P.M. Madera /
				R.P.M. Mild steel / R.P.M. Acier doux		R.P.M. Casting / R.P.M. Fonte	R.P.M. Aluminium / R.P.M. Aluminium	R.P.M. Brass / R.P.M. Laiton	R.P.M. Wood / R.P.M. Bois
64550	14	9/16	54	620	300	400	900	790	3000
64551	16	5/8		545	260	360	810	735	
64552	17	11/16		510	250	340	770	690	
64553	19	3/4		460	220	300	685	620	
64664	20	-		430	210	290	650	590	
64554	21	13/16		415	200	275	620	560	
64555	22	7/8	50	395	190	260	590	535	2750
64556	24	15/16		360	175	240	540	490	
64557	25	1		350	175	235	525	470	
64558	27	1.1/16		320	160	215	480	435	
64559	28	-		310	150	205	450	405	
64560	29	1.1/8		300	145	200	430	390	
64561	30	1.13/16		290	140	190	410	370	
64562	32	1.1/4		270	130	180	390	355	
64563	33	1.5/16		265	125	175	370	335	
64564	35	1.3/8		250	120	165	350	320	
64565	37	1.7/16	2400	235	115	155	340	310	
64566	38	1.1/2		230	110	150	325	295	
64567	40	1.9/16		215	105	145	315	285	
64568	41	1.5/8		210	100	140	300	275	
64569	43	1.11/16		200	95	135	295	270	
64570	44	1.3/4		195	95	130	280	255	
64571	46	1.13/16		190	90	125	270	245	
64572	48	1.7/8		180	90	120	255	230	
64573	51	2		170	85	115	245	220	
64574	52	2.1/16		165	80	110	240	215	
64575	54	2.1/8	2100	160	75	105	230	205	
64576	57	2.1/4		150	75	100	220	200	
64577	59	2.5/16		145	70	100	215	195	
64578	60	2.3/8		140	70	95	205	185	
64579	64	2.1/2		135	65	90	200	180	
64580	65	2.9/16		135	65	90	195	175	
64581	67	2.5/8		130	60	85	190	170	
64582	70	2.3/4		125	60	85	185	165	
64583	73	2.7/8		1800	120	55	80	180	160
64584	76	3			115	55	80	170	150
64585	79	3.1/8	110		55	75	165	145	
64586	83	3.1/4	105		50	75	155	140	
64587	86	3.3/8	100		50	70	150	135	
64588	89	3.1/2	95		45	65	145	130	
64589	92	3.5/8	95		45	65	140	125	
64590	95	3.3/4	90		45	60	135	120	
64591	98	3.7/8	88		40	60	130	120	
64592	102	4	85		40	55	125	110	
64593	105	4.1/8	1500	83	40	55	120	110	
64594	108	4.1/4		80	40	55	120	110	
64595	110	4.5/16		78	35	50	115	105	
64596	114	4.1/2		76	35	50	115	105	
64597	121	4.3/4		72	35	45	110	100	
64598	127	5		68	30	45	100	90	
64599	140	5.1/2		62	30	40	90	85	
64600	152	6		55	25	30	85	75	

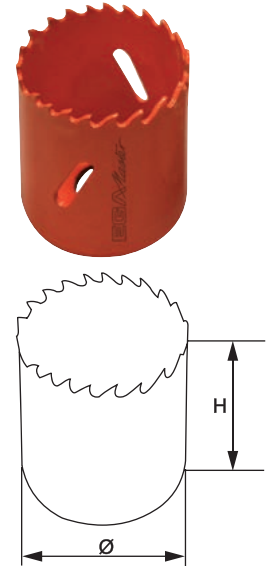

HUSILLO / ARBOR / VÉRIN / HALTER / SUPPORTO / FUSO / ОПРАВКА

COD.	O.D. mm	O.D. inch	AF mm	AF inch	
64601	14-30	9/16-1.13/16	9,52	3/8	1
64602	32-152	1.1/4-6	11,1	7/16	



CONECTOR ADAPTADOR ROSCA / THREAD CONNECTION ADAPTER / CONNECTEUR ADAPTATEUR DE FILETAGE / ADAPTER FÜR GEWINDE / ADDATTATORE CONNETTORE PER FILIERA / ADAPTADOR DE ROSCA / РЕЗЬБОВОЙ АДАПТОР

COD.	g		
64612	20	10	•



ALARGADERA / EXTENSION / RALLONGE / VERLÄNGERUNG / PROLUNGA / EXTENÇÃO / УДЛИНИТЕЛЬ

COD.	AF mm	AF inch	L (mm)	g		
64613	11,1	7/16	300	290	10	•



BROCA / DRILL / МЁСЧЕ / BOHRER / PUNTE / BROCA / СВЕРЛО

COD.	L (mm)	O.D. mm	g		
64614	75	6,3	15	10	•



JUEGOS DE CORONA BIMETAL / BI-METAL HOLE SAW SETS / JEUX DE SCIES CLOCHES BI-METAL / BI-METALL LOCHSÄGE SÄTZE / SET DI SEGA A TAZZA BIMETALLICA / JOGOS DE BROCAS CRANEANAS / КОМПЛЕКТЫ ВРЕЗНЫХ БИМЕТАЛЛИЧЕСКИХ КОРОНОК

9 PCS.

COD.	PCS.	g	
57655	9	1250	1

PCS. Composición / Composition / Composition

6	64550, 64554, 64559, 64565, 64571, 64578	14-21-28-37-46-60 mm 9/16-13/16-1.7/64-1.7/16-1.13/16-2.3/8 inch	
2	64601, 64602		
1	64612		



COD.	PCS.	g	
57656	9	1200	1

PCS. Composición / Composition / Composition

6	64552, 64554, 64559, 64565, 64568, 64576	17-21-28-37-41-57 mm 11/16-13/16-1.7/64-1.7/16-1.5/8-2.1/4 inch	
2	64601, 64602		
1	64612		

COD.	PCS.		
57657	9	1200	1

PCS. Composición / Composition / Composition

6	64554, 64557, 64562, 64565, 64571, 64574	21-25-32-37-46-52 mm 13/16-1-1.1/4-1.7/16-1.13/16-2.1/16 inch	
2	64601, 64602		
1	64612		



COD.	PCS.		
57658	9	1250	1

PCS. Composición / Composition / Composition

6	64554, 64559, 64565, 64568, 64576, 64580	21-28-37-41-57-65 mm 13/16-1.7/64-1.7/16-1.5/8-2.1/4-2.9/16 inch	
2	64601, 64602		
1	64612		

COD.	PCS.		
64615	9	1200	1

PCS. Composición / Composition / Composition

6	64553, 64555, 64564, 64566, 64570, 64581	19-22-35-38-44-67 mm 3/4-7/8-1.3/8-1.1/2-1.3/4-2.5/8 inch	
2	64601, 64602		
1	64612		

COD.	PCS.		
64651	9	900	1

PCS. Composición / Composition / Composition

6	64551, 64554, 64557, 64562, 64567, 64573	16-21-25-32-40-51 mm 5/8-13/16-1-1.1/4-1.9/16-2 inch	
2	64601, 64602		
1	64612		

■ 10 PCS.

N!		COD.	PCS.		
		57533	10	1550	1
PCS.		Composición / Composition / Composition			
7	64550, 64552, 64557, 64562, 64568, 64574, 64578	14-17-25-32-41-52-60 mm 9/16-11/16-1.1/4-1.5/8-2.1/16-2.3/8 inch			
2	64601, 64602				
1	64612				



■ 12 PCS.





N!		COD.	PCS.		
		57532	12	1800	1
PCS.		Composición / Composition / Composition			
8	64550, 64552, 64557, 64562, 64565, 64571, 64574, 64580	14-17-25-32-37-46-52-65 mm 9/16-11/16-1.1/64-1.17/64-1.7/16-1.13/16-2.1/16- 2.9/16 inch			
2	64601, 64602				
1	64612				
	64613				

N!		COD.	PCS.		
		57534	12	1900	1
PCS.		Composición / Composition / Composition			
8	64552, 64554, 64559, 64562, 64568, 64571, 64576, 64580	17-21-28-32-41-46-57-65 mm 11/16-13/16-1.7/64-1.1/4-1.5/8-1.13/16-2.1/4-2.9/16 inch			
2	64601, 64602				
1	64612				
	64613				

■ 14 PCS.

N!		COD.	PCS.		
		64616	14	2100	1
PCS.		Composición / Composition / Composition			
10	64553, 64555, 64560, 64564, 64566, 64570, 64573, 64576, 64579, 64581	19-22-29-35-38-44-51-57-64-67 mm 3/4-7/8-1.1/8-1.3/8-1.3/4-2-2.1/4-2.1/2-2.5/8 inch			
2	64601, 64602				
1	64612				
	64613				



■ **BROCA ESCALONADA / STEP DRILL / MÈCHE ÉCHELONNÉE / SPIRALBOHRER / PUNTA SCANALATA / BROCA ESCALONADA / СТУПЕНЧАТОЕ СВЕРЛО**

COD.				
64617	4-12	25	1	●
64618	4-20	60		
64619	4-30	180		





■ **SET**

■ **3 PCS.**

COD.	PCS.		
64620	3	300	1
PCS.		COD.	
1		64617	Ø 4-12 mm
		64618	Ø 4-20 mm
		64619	Ø 4-30 mm



■ **SACABOCADOS / HOLLOW PUNCHES / EMPORTE PIÈCES / HENKELLOCHEISEN / SACABOCADOS / SACA BOCADOS / ВЫРУБАТЕЛИ ПРОКЛАДОК**

COD.		L (mm)		
64671	5	27	15	10
64672	6		20	
64673	8		25	
64674	10		30	
64675	12,5		40	
64676	16		50	
64677	20		60	
64678	25		80	
64679	32			

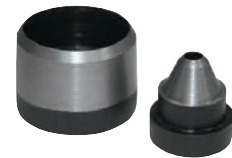



COD.			
64680	5-32	250	1



■ **SET**

■ **10 PCS.**

COD.	PCS.		
64670	10	900	1
Composición / Composition / Composition			
64671, 64672, 64673, 64674, 64675, 64676, 64677, 64678, 64679		5-6-8-10-12,5-16-20 25 32 mm	



ELECTROPORTÁTIL / BATTERY PORTABLE / ÉLECTROPORTATIF / TRAGBARE BATTERIE / ELECTROPORTÁTIL / BATERIA PORTÁTIL / ПОРТАТИВНЫЙ АККУМУЛЯТОРНЫЙ**TALADRO ATORNILLADOR A BATERÍA / CORDLESS DRILL / DRIVER / PERCEUSE-VISSEUSE À BATTERIE / AKKU-BOHRMASCHINE / TRAPANO AVVITATORE A BATTERIA / BERBEQUIM / APARAFUSADORA A BATERIA / АККУМУЛЯТОРНАЯ ДРЕЛЬ/ШУРУПОВЕРТ**

COD.	V	Bat.	Nm/Lb.ft	CAP. (mm)	Kg
58887	18V	Li-Ion	45/33	13	2,2

ESPECIFICACIONES TÉCNICAS / TECHNICAL SPECIFICATION / DÉTAILS TECHNIQUES

Pares prefijados / Preset Torque values / Paires Préétablies 15 + BROCA / 15 + DRILLING / 15+ MÊCHE

Velocidad en vacío / Free speed / Vitesse à vide 340-1220 rpm

Reversible / Reversible / Réversible ●

EQUIPADO CON / EQUIPED WITH / EQUIPE

Batería / Battery / Batterie

Estación de carga / Charging station / Station de chargement

Gancho para cinturón / Belt clip / Attache pour ceinture

Maleta / Case / Malette

CARACTERÍSTICAS / FEATURES / CARACTÉRISTIQUES

Carcasa y engranajes planetarios íntegramente metálicos / Completely metallic planetary gears and housing /

Carcasse et engrenages planétaires complètement métalliques

**LLAVE DE IMPACTO / IMPACT WRENCH / CLE À CHOC / SCHLAGSCHRAUBER / AVVITATORE AD IMPULSI / CHAVE DE IMPACTO / УДАРНЫЙ ВИНТОВЕРТ**

COD.	AF $\frac{1}{2}$ inch	V	Bat.	Nm/Lb.ft	Kg
58888	1/2"	18V	Li-Ion	590/435	2,4

ESPECIFICACIONES TÉCNICAS / TECHNICAL SPECIFICATION / DÉTAILS TECHNIQUES

Velocidad en vacío / Free speed / Vitesse à vide 1650 rpm

Reversible / Reversible / Réversible ●

EQUIPADO CON / EQUIPED WITH / EQUIPE

Batería / Battery / Batterie

Estación de carga / Charging station / Station de chargement

Maleta / Case / Malette

**ACCESORIOS / ACCESSORIES / ACCESSOIRES / ZUBEHÖR / ACCESSORI / ACESSORIOS / ЗАПАСНЫЕ ЧАСТИ**

COD.	Descripción / Description / Description	V
58889	Batería / Battery / Batterie	18V



COD.	Descripción / Description / Description	V
58890	Cargador / Charger / Chargeur	18V



■ BROCAS / TWIST DRILL / MÈCHES / BOHRER / PUNTE PER TRAPANO / BROCAS / СВЕРЛО

■ HSS

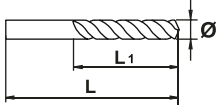

N!

COD.	O.D. mm	L (mm)	L1 (mm)	g	
66281	0,5	22	6		
66282	1	34	12		
66283	1,2	38	16	1	
66284	1,5	40	18		
66285	1,7	43	20		
66286	2	49	24		
66287	2,2	53	27		
66288	2,5	57	30	2	
66289	2,7	61	33		
66290	3	75	43		
66291	3,2	65	36	3	
66292	3,3				
66293	3,5	70	39	4	
66294	3,7				
66295	4				
66296	4,2	75	43	5	
66297	4,3			6	
66298	4,5	80	47	7	10
66299	4,7				
66300	5				
66301	5,2	86	52	8	
66302	5,5				
66303	5,7	93	57	9	
66304	6			10	
66305	6,2				
66306	6,5	101	63	15	
66307	6,7				
66308	7			20	
66309	7,5	109	69	25	
66310	8				
66311	8,5	117	75	30	
66312	9			35	
66313	9,5	125	81	40	
66314	10	133	87	50	
66375	10,5	135		55	
66315	11				
66316	11,5	142	94	65	
66317	12				
66318	12,5	151	101	80	
66319	13			85	
66320	14	160	108		5
66321	15			90	
66322	16	178	120	100	
66323	17	184	125		
66324	18	191	130	150	
66325	19	198	135		
66326	20	205	140	200	



DIN 338

KIT

COD.	PCS.	
66327	19	300

DIN 338



COD.	PCS.	
66328	25	750

DIN 338



HSS-CO

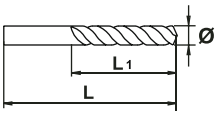

COD.	O.D. (mm)	L (mm)	L1 (mm)		
66329	1	34	12	1	
66330	1,25	38	16		
66331	1,5	40	18		
66332	1,75	46	22		
66333	2	49	24		
66334	2,25	53	27	2	
66335	2,5	57	30		
66336	2,75	61	33		
66337	3	75	43		
66338	3,25	65	36		
66339	3,5	70	39	4	
66340	3,75	75	43		
66341	4	75	43		
66342	4,25	75	43		
66343	4,5	75	43		
66344	4,75	80	47	7	10
66345	5	86	52	8	
66346	5,25	86	52		
66347	5,5	86	52		
66348	5,75	93	57		
66349	6	93	57		
66350	6,25	93	57	9	
66351	6,5	101	63		
66352	6,75	101	63		
66353	7	109	69		
66354	7,25	109	69		
66355	7,5	109	69	10	
66360	7,75	109	69		
66361	8	109	69		
66362	8,25	117	75		
66363	8,5	117	75		
66364	8,75	117	75	15	
66365	9	117	75		
66366	9,25	125	81		
66367	9,5	125	81		
66368	9,75	125	81		
66369	10	133	87	20	5
66370	10,5	133	87		
66371	11,5	142	94		
66372	12	142	94		
66374	12,5	151	101		



DIN 338

HSS STANDARD REDUCIDA / HSS DRILL BIT WITH REDUCED SHANK / HSS STANDARD RÉDUIT / HSS BOHRER MIT REDUZIERTEM SCHAFT / HSS STANDARD RIDOTTA / BROCA HSS COM CONE REDUZIDO / СВЕРЛО HSS С УМЕНЬШЕННЫМ ХВОСТОВИКОМ

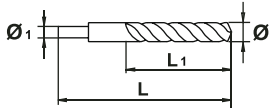

COD.	O.D. mm	Ø 1 (mm)	L (mm)	g	
66376	13,5	12,7	133	100	1
66377	14		160	115	
66378	14,5		169	120	
66379	15		178	140	
66380	15,5			155	
66381	16		184	160	
66382	16,5			184	
66383	17		191	200	
66272	17,5			191	
66273	18		198	230	
66274	18,5			198	
66275	19		205	260	
66276	19,5			205	
66277	20				



DIN 338

