

SAFETY PRODUCTS

StatusBus

ABB Jokab Safety



- Cost effective status information using fewer cables and I/Os
- Reduced installation time
- Speed up trouble shooting and reduce downtime

Reduce installation time and downtime

Connect in series and still know the status of each device with StatusBus

StatusBus is an add-on function to the DYNlink solution. Using just one of the existing leads in an M12-5 cable, it keeps track of the status of all devices connected in series. This makes it a simple and cost effective way to monitor the status of each single door or emergency stop. It reduces the time for trouble shooting and makes sure the operator has instant knowledge of the status of the safety system.

Reduced installation time

The devices are connected in series with standard cable and M12-5 connectors. Connection in series saves cable length and connection time. M12 connectors not only reduce connection time, but also eliminate the risk for connection errors.

Reduce downtime and increase productivity

The operator gets status information from each device and does not need to look for e.g. the emergency stop button that has been pushed, thus reducing troubleshooting time. A LED on the device not only gives information on the status of the device, but also on the status of the incoming safety signal allowing the detection of possible connection problems between two devices. With our DYNlink solution, PL e can be reached with only one safety channel and a two-channel fault, which could be difficult to identify, cannot occur.

Cost effective I/O saving solution

With our DYNlink solution, only one safety input is necessary for each safety device when two are necessary with traditional safety devices to reach the same PL. Moreover, only one I/O is needed on the Safety PLC to obtain the status of up to 30 devices. No specific bus cable is necessary, no extra communication module either.

The operator can see the status of each push button and sensor on the display, even though all the devices are connected in series.



01 Connection example

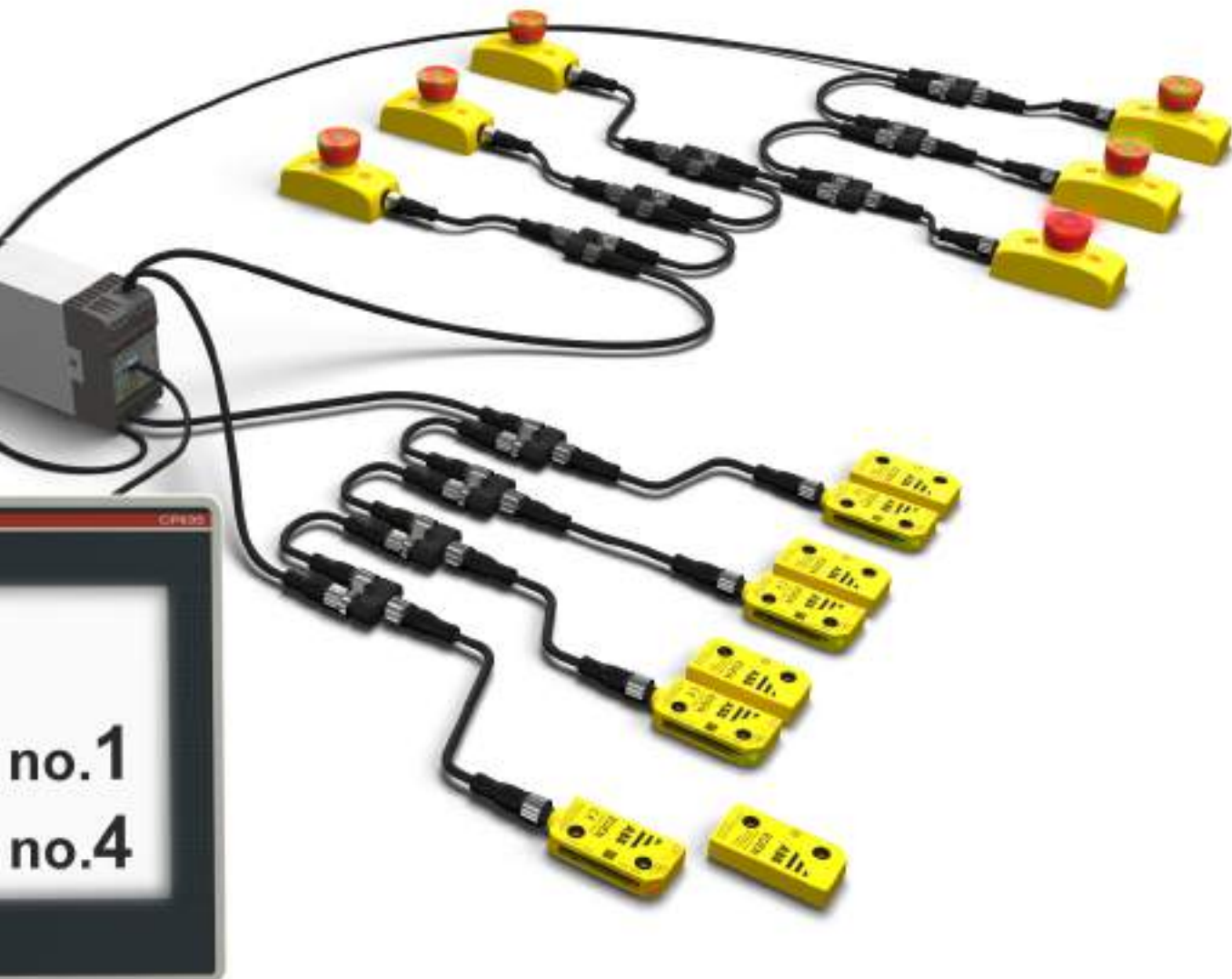

StatusBus products

The StatusBus functionality is available for the Eden non-contact sensor in order to be able to display the status of doors and hatches on a machine. It is also available for Smile and Inca emergency stops in order to quickly be able to locate which button was pressed on larger machine lines.

—
01 Smile emergency stop button

—
02 Inca emergency stop button for panel mounting

—
03 Eden non-contact sensor

Smile emergency stop button

Smile is a compact emergency stop button. Thanks to its small size and its centered mounting holes, Smile is easy to position and install wherever needed. The M12 connectors speed up the connection and reduce the risk of connection error. A bright LED placed in the center of the push-button tells whether it is pushed. Smile complies with PL e/SIL3.

Inca emergency stop button for panel mounting

Inca is an emergency stop for panel mounting. Its removable terminal facilitates connection. A bright LED placed in the center of the push-button tells whether it is pushed. Inca complies with PL e/SIL3.

Eden non-contact sensor

Eden is a non-contact sensor consisting of two separate parts - Adam and Eva. With a large mounting tolerance and excellent resistance to harsh environments, Eden is intended for use as interlocking device for gates, hatches etc. Up to ten Eden sensors can be connected to one Pluto input, without reducing the achieved performance level. Eden complies with PL e/SIL3. Adam and Eva are ordered separately and it is possible to mix different models of Adam DYN in the same safety circuit. The integrated LED shows if Adam and Eva have established contact (i.e. the door is closed).



01



02



03

StatusBus products

Pluto is a cost effective, powerful and compact programmable safety controller used in a variety of applications: in large and small systems, for process as well as functional safety.

— 01 Pluto programmable safety controller

— 02 Pluto Manager software screen shot

Pluto programmable safety controller

Pluto complies with PL e/SIL3 and can be used with all common types of safety devices and is available in several different models to fit most machine safety applications.

Pluto is programmed with Pluto Manager, a software that can be downloaded free of charge from our website. Pluto Manager allows for programming with TÜV approved function blocks and Ladder logic and for programming in text. Despite a short learning curve, even for the less experienced programmers, Pluto Manager offers many advanced functions. One of the many functions appreciated by the users is online monitoring capability from any Pluto in the system. It speeds up development and troubleshooting while the possibility to replace a Pluto with no need for new programming reduces downtime.

Extended communication possibilities enhance the flexibility of Pluto: communication with other Pluto units, communication with other control systems, and communication with HMIs. Up to 32 Pluto units can easily be connected to each other and exchange data without extra lines of program. Both the merging of several Pluto systems and the splitting of a system containing several Pluto are very simple operations. Pluto also simplifies the connection between cabinets in accordance with PL e/SIL3 and the AS-i models reduce cabling to a minimum while eliminating most risks of incorrect connection.



Connection example

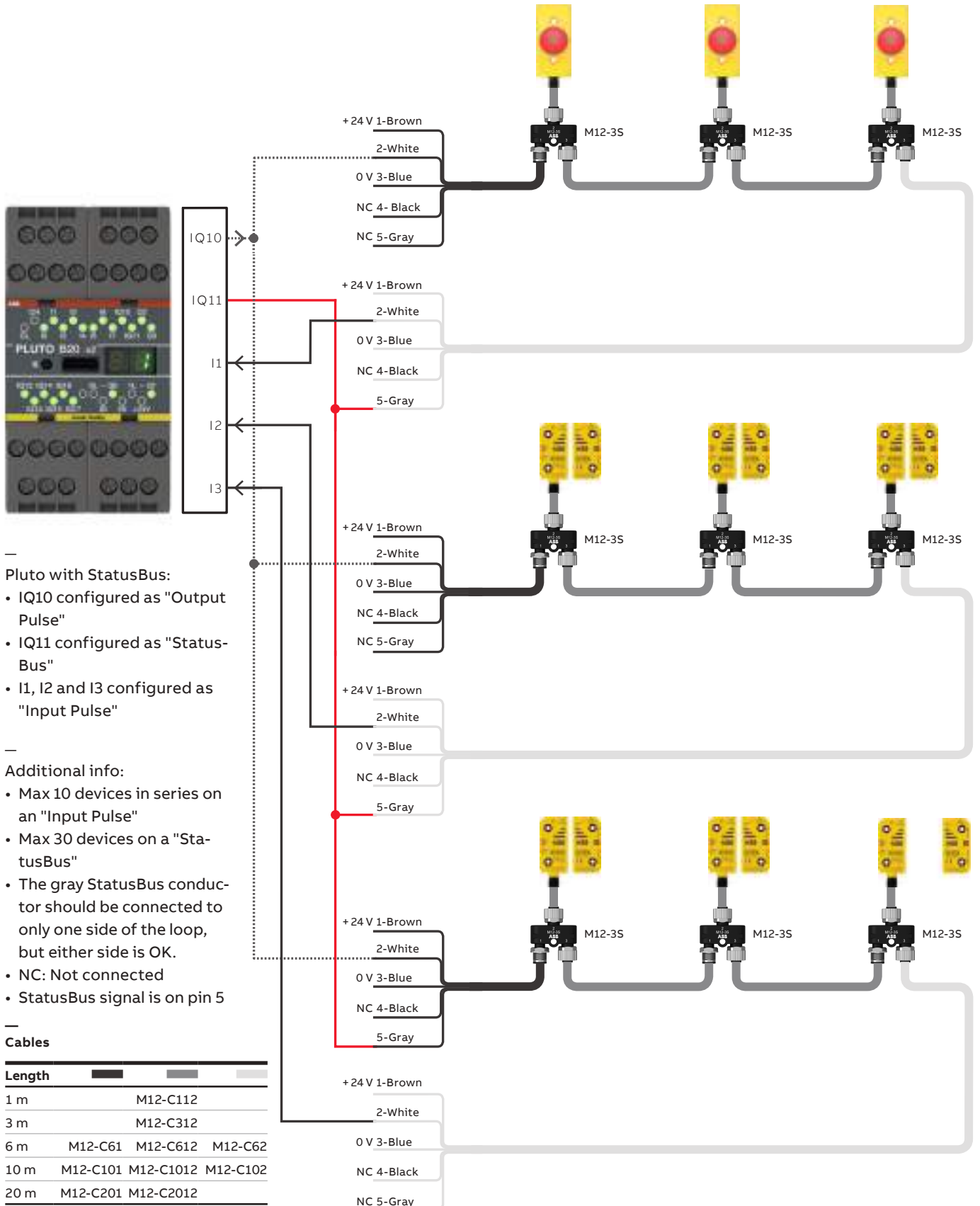

- Pluto with StatusBus:
- IQ10 configured as "Output Pulse"
 - IQ11 configured as "Status-Bus"
 - I1, I2 and I3 configured as "Input Pulse"

- Additional info:
- Max 10 devices in series on an "Input Pulse"
 - Max 30 devices on a "StatusBus"
 - The gray StatusBus conductor should be connected to only one side of the loop, but either side is OK.
 - NC: Not connected
 - StatusBus signal is on pin 5

Cables

Length			
1 m		M12-C112	
3 m		M12-C312	
6 m	M12-C61	M12-C612	M12-C62
10 m	M12-C101	M12-C1012	M12-C102
20 m	M12-C201	M12-C2012	

Technical information

In order to offer serial connection with individual status information, the devices must be DYNlink compatible and have the StatusBus functionality and the safety control module must be a Pluto programmable safety controller.

- 01 FIXA, Handheld terminal for sensors
- 02 Print screen showing the connected StatusBus devices in Pluto Manager
- 03 Print screen showing a StatusBus function block in Pluto Manager

Products available with StatusBus function:

- Eden DYN non-contact safety sensor
- Smile Tina emergency stop button
- Inca Tina emergency stop button
- Pluto programmable safety controller
- Fixa addressing unit

The products equipped with the StatusBus functionality are identified by this icon:

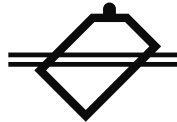

- Pluto must have OS 3.6.1 or higher. Pluto Manager v 2.26 (or later) is necessary. Both can be downloaded from our website.
- The status of 30 safety devices can be connected to one I/O configured as StatusBus.
- The safety signal of 10 DYNlink devices can be connected in series to one input configured as DYNlink input.
- Up to 4 I/O's on a Pluto can be configured as StatusBus I/O's (IQ10 to IQ13).
- DYNlink devices with and without the StatusBus functionality can be mixed in the same circuit.

Note: When using ABB Jokab Safety DYNlink devices, like Eden DYN StatusBus, Smile Tina and Inca Tina, only one safety channel is necessary to reach a PL e, thus reducing the number of necessary inputs on the safety controller and eliminating the risk of two-channel fault.

Addressing

- Each device connected to a StatusBus I/O on the Pluto must have an address between 1 and 30. The devices have address 0 at delivery.
- The devices are easily addressed with the Fixa addressing unit and/or Pluto Manager. The numbers of the addresses do not have to follow the order of the physical connection.
- The “Teach address” function in Pluto Manager facilitates addressing: connect all devices with the StatusBus functionality to the Pluto and press all the buttons/open all doors (OFF state). Select the “Teach function” in Pluto Manager, choose an address (1 to 30) and release the button/close the door that should have this address (ON state). Repeat the same procedure until all devices have an address.
- If a device has to be replaced, the new device will automatically receive the address of the old one as long as only a single device is missing at a time.
- The “Read slaves” function allows to check the addresses of the devices connected to the bus.
- Pluto Manager can request that a device identifies itself: the device with the specified address will flash its LED in a specified way.

Please refer to the Pluto documentation for more information about the Pluto programmable safety controller and its complimentary programming software, Pluto Manager.



01

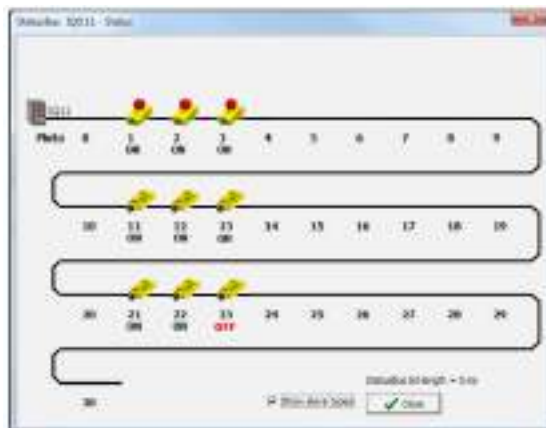

02

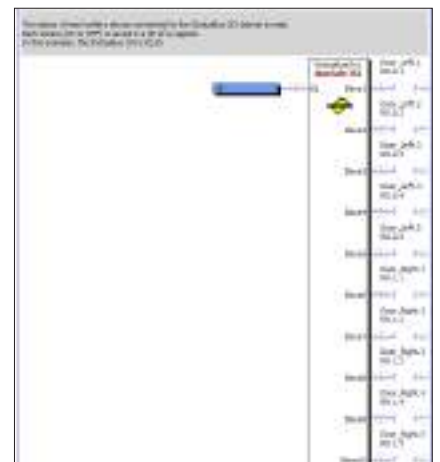

03

Ordering information

Pluto

Pluto

Pluto is available in different models depending on the needs of your application. Optional features includes bus communication, AS-i bus, high resolution analog inputs, current monitoring and adaption for harsh environments.

Title	AS-i	Safety bus	Failsafe outputs ^{a)}	Failsafe inputs ^{b)}	Analog inputs ^{b)}	Fast counter inputs ^{b)}	StatusBus inputs ^{b)}	Non failsafe outputs ^{b)}	Width mm	Type	Order code	
	No	No	4	16	1 ^{c)}	-	4	8	45	Pluto S20	2TLA020070R4700	
			6	40	3 ^{c)}	-	4	16	90	Pluto S46	2TLA020070R1800	
			Yes	-	22	1 ^{c)}	-	4	8	45	Pluto B22 ^{e)}	2TLA020070R4800
				2	4	-	-	2	2	45	Pluto O2 ^{f)}	2TLA020070R8500
				4	16	1 ^{c)}	-	4	8	45	Pluto A20 ^{g)}	2TLA020070R4500
						4 ^{d)} + 1 ^{c)}	-	4	8	45	Pluto B20	2TLA020070R4600
									Pluto D20 (Harsh Env) ^{h)}	2TLA020070R6401		
	Yes	Yes	4	8	4 ^{c)}	-	4	4	45	Pluto AS-i	2TLA020070R1100	
			6	40	3 ^{c)}	-	4	16	90	Pluto B46	2TLA020070R1700	
				39	8 ^{d)}	4	4	15	90	Pluto D45	2TLA020070R6600	
											Pluto D45 (Harsh Env) ^{h)}	2TLA020070R6601
											Pluto B42 AS-i	2TLA020070R1400

a) Failsafe outputs

2 failsafe outputs:

- 2 individually safe potential free relay outputs (Q0 and Q1) with 3 contacts each

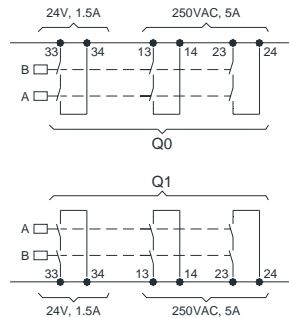

4 failsafe outputs:

- 2 individually safe potential free relay outputs (Q0 and Q1)
- 2 individually safe transistor outputs (-24 VDC) (Q2 and Q3)

6 failsafe outputs:

- 2 individually safe potential free relay outputs (Q0 and Q1)
- 2 individually safe potential free relay outputs with common supply (Q4 and Q5)
- 2 individually safe transistor outputs (-24 VDC) (Q2 and Q3)

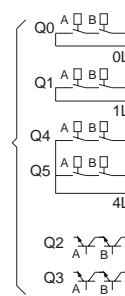

b) -The number of failsafe inputs available decreases with the number of used non-failsafe outputs, analog inputs, fast counter inputs and StatusBus inputs.

-The number of analog inputs available decreases with the number of used fast counter inputs.

-The number of non-failsafe outputs available decreases with the number of StatusBus inputs used.

Check the [Pluto hardware manual](#) for more information

c) 0-27 V analog inputs

d) 0-10 V/4-20 mA (high resolution) analog inputs

e) Expansion module with failsafe inputs and non-failsafe outputs (e.g. without failsafe outputs).

f) Expansion model with 2 failsafe outputs with 3 contacts each. Also possible to use as stand-alone unit.

g) Model with current monitoring

h) Pluto D20 (Harsh Env) and Pluto D45 (Harsh Env) have coated circuit boards and can be used in severe environments where cold and condensation can cause problems, like on trains and other vehicles and in the wind energy segment.

- They comply with railway standard EN 50155

- They can be used on all trains up to the highest hazard level (HL3) according to the fire and smoke protection standard EN 45545.

Ordering information

Safety devices

Safety device	Description	Type	Order code
	Non-contact safety sensor, with M12-5 male contact (mandatory)	Adam DYN-Status M12-5	2TLA020051R5200
	Non-contact safety sensor, with general code (chose one)	Eva General code	2TLA020046R0800
	Non-contact safety sensor, with unique code (chose one)	Eva Unique code	2TLA020046R0900

Safety device	Description	Type	Order code
	Emergency stop button with StatusBus functionality	Smile 11 EC Tina	2TLA030050R0900

Safety device	Description	Type	Order code
	Emergency stop button for panel mounting with StatusBus functionality	Inca 1 EC Tina	2TLA030054R1400

Ordering information

Accessories

Accessory	Description	Type	Order code
Fixa 	Handheld terminal AS-i/StatusBus – used for e.g. addressing	Fixa	2TLA020072R2000

Accessory	Description	Type	Order code
M12 Y-connector 	M12 Y-connector for serial connection of DYNlink devices with StatusBus functionality	M12-3S	2TLA020055R0600
	M12 Y-connector for serial connection of DYNlink devices without StatusBus functionality	M12-3A	2TLA020055R0000

Accessory	Description	Type	Order code
Connection block 	Connection block for up to 4 DYNlink devices	Tina 4	2TLA020054R0300
	Connection block for up to 8 DYNlink devices	Tina 8	2TLA020054R0500

Accessory	Description	Type	Order code
Cables 	10m cable with 5 x 0.34 shielded conductors	C5 10m	2TLA020057R0001
	50m cable with 5 x 0.34 shielded conductors	C5 50m	2TLA020057R0005
	100m cable with 5 x 0.34 shielded conductors	C5 100m	2TLA020057R0010
	200m cable with 5 x 0.34 shielded conductors	C5 200m	2TLA020057R0020
	500m cable with 5 x 0.34 shielded conductors	C5 500m	2TLA020057R0050

Accessory	Description	Type	Order code
Cables with connectors 	Straight M12-5 female connector with 6 m shielded cable	M12-C61	2TLA020056R0000
	Straight M12-5 female connector with 10 m shielded cable	M12-C101	2TLA020056R1000
	Straight M12-5 female connector with 20 m shielded cable	M12-C201	2TLA020056R1400
	Straight M12-5 female + male connectors with 1 m shielded cable	M12-C112	2TLA020056R2000
	Straight M12-5 female + male connectors with 3 m shielded cable	M12-C312	2TLA020056R2100
	Straight M12-5 female + male connectors with 6 m shielded cable	M12-C612	2TLA020056R2300
	Straight M12-5 female + male connectors with 10 m shielded cable	M12-C1012	2TLA020056R2300
	Straight M12-5 female + male connectors with 20 m shielded cable	M12-C2012	2TLA020056R2400



ABB AB

Jokab Safety

Varlabergsvägen 11

SE-434 39 Kungsbacka

Tel. +46 (0) 21-32 50 00

www.abb.com/jokabsafety

Note

We reserve the right to make technical changes or modify the contents of this document without prior notice. With regard to purchase orders, the agreed particulars shall prevail. ABB does not accept any responsibility whatsoever for potential errors or possible lack of information in this document.

We reserve all rights in this document and in the subject matter and illustrations contained therein. Any reproduction, disclosure to third parties or utilization of its contents – in whole or in parts – is forbidden without prior written consent of ABB.