

NEMA Push Button Specifications

Catalog Numbers 800T and 800H

Topic	Page
800T/H Specifications	2
800T/H DeviceNet Stations	4
800T/H Trigger Action E-stops	5
800T/H Momentary Contact Push Buttons	7
800T/H Selector Switch	10
800T/H Pilot Lights	18
800T/H Push-Pull and Twist-to-release Devices	19
800T Cluster Pilot Lights	23
800T Toggle Switches	24
800T Selector Push Button	25
800H Momentary Contact Flip Lever Devices	26
800T/H Protective Boot Application Information	27
800T/H Approximate Dimensions	28
800T/H Typical Pilot Light Wiring Diagrams	40
800H Push Button Enclosures	41

Additional Resources

These documents contain additional information concerning related products from Rockwell Automation.

Resource	Description
Industrial Automation Wiring and Grounding Guidelines, publication 1770-4.1	Provides general guidelines for installing a Rockwell Automation industrial system.
Product Certifications website, http://www.ab.com	Provides declarations of conformity, certificates, and other certification details.

You can view or download publications at <http://www.rockwellautomation.com/literature/>. To order paper copies of technical documentation, contact your local Allen-Bradley distributor or Rockwell Automation sales representative.



Specifications ★

Electrical Ratings		
Contact ratings	Refer to the contact ratings tables on page 10-4.	
Dielectric strength	2200V for one minute, 1300V for one minute (Logic Reed)	
Mechanical Ratings		
Vibration	10...2000 Hz, 1.52 mm displacement (peak-to-peak) max./ 10 G max. (except Logic Reed)	
Shock	1/2 cycle sine wave for 11 ms ≥ 25 g (contact fragility) and no damage at 100 g	
Degree of protection	Type 1/4/12/13 (800T); Type 1/4/4X/12/13 (800H); EN/IEC 60529 IP66/65	
Mechanical design life cycles		
Push buttons	(Momentary, non-illuminated, flush and extended head)	10,000,000 min.
	(Momentary, illuminated)	250,000 min.
	(Push-pull/twist-to-release)	250,000 min. ‡
Selector switches	(Non-illuminated)	1,000,000 min.
	(Illuminated, key-operated)	200,000 min.
Potentiometers	25,000 min.	
All other devices	200,000 min.	
Contact operation	Shallow, mini, and low-voltage contact blocks: Slow, double make and break Logic Reed and sealed switch contact blocks: Single break magnetic	
Wire gauge/Terminal screw torque	#18...14 AWG (#18...10 Max Duty) / 6...8 lb•in	
Typical operating forces		
Operators without contact blocks	Flush, extended button, standard mushroom, jumbo plastic mushroom: 2 lbs max. Jumbo and extended aluminum mushroom head: 3.95 lbs max. Maintained selector switch: 3.6 in•lb max.	
Spring return selector switches	3.6 in•lb to stop, 0.2 in•lb to return	
Illuminated push buttons and push-to-test pilot lights	5 lb max.	
2-position push-pull	8.0 lb max. push or pull	
3-position push-pull	8 lb max. push to in position or pull to center position (15 lb max. pull to out position)	
Twist-to-release or push-pull	9 lbs max. push or pull 30 in•oz max. twist, 6 in•oz minimum return	
Potentiometer	Rotational torque 3...12 in•oz; stopping torque 12 in•lb (minimum)	
Contact blocks	Standard	1 lb
	Logic Reed	1 lb max.
	Sealed switch	3 lb max. at 0.205 in. plunger travel
	Stackable sealed switch	1 lb max.
	MaxDuty	1.4 lb max.
	PenTUFF	1.4 lb max.
Self Monitoring	1.6 lb	
Environment		
Temperature range	Operating	-40...+131 °F (-40...+55 °C)
	Storage	-40...+185 °F (-40...+85 °C)
Note: Operating temperatures below freezing are based on the absence of moisture and liquids. Consult your local Rockwell Automation sales office or Allen-Bradley distributor for use in lower temperature applications.		
Humidity	50...95% RH from 77...140 °F (25...60 °C) per Procedure IV of MIL-STD-810C, Method 507.1 cycling test	

★ **Performance Data** — Performance data given in this publication is provided only as a guide for the user in determining suitability and do not constitute a performance warranty of any kind. Such data may represent the results of accelerated testing at elevated stress levels, and the user is responsible for correlating the data to actual application requirements. ALL WARRANTIES AS TO ACTUAL PERFORMANCE, WHETHER EXPRESS OR IMPLIED, ARE EXPRESSLY DISCLAIMED.

‡ Illuminated Trigger Action E-stops are rated for 150,000 min. mechanical operations when using Cat. No. 800TC-XD4S Self-Monitoring Contact Blocks (SMCBs).

Standard Contact Ratings

Minimum: 24V, 24 mA

Maximum thermal continuous current I_{th} 10 A AC/2.5 A DC. Bulletin 800T units with 800T-XA contacts have ratings as follows:

Max. Opertnl. Volts U_e	Utilization Category		Rated Operational Currents		
	IEC	NEMA	Volts U_e	Make	Break
AC 600	AC-15	A600	120...600	7200VA	720VA
			72...120	60 A	720VA
DC 600	DC-13	Q600	24...72	60 A	10 A
			28...600	69VA	
			24...28★	2.5 A	

★ For applications below 17V/5 mA, PenTUFF or Logic Reed contacts are recommended.

Electrical design life cycles: 1,000,000 (at max. rated load)

Explosion-Protected Contact Ratings

Max. Opertnl. Volts U_e	Utilization Category		Rated Operational Currents		
	IEC	NEMA	Volts U_e	Make	Break
AC 600	AC-15	A600	120...600	7200VA	720VA
			72...120	60 A	720VA
DC 600	DC-13	Q600	24...72	60 A	10 A
			28...600	69VA	
			24...28	2.5 A	

Maximum thermal continuous current I_{th} = 10 A
 Minimum low energy switching load: 17V DC, 5 mA
 Electrical design life cycles: 1,000,000 (24V DC, 25 mA)
 Vibration: 5 g, 0.7 mm peak-to-peak displacement, sine sweep 10...2000 Hz / IEC 60068-2-6
 Shock: 15 g (800H-TFRX trigger action E-stops), 50 g (all other devices) / IEC 60068-2-27

Sealed Switch Contact Ratings

Minimum: 5V, 1 mA

Maximum continuous current I_{th} 5 A. Bulletin 800T units have control circuit ratings with sealed switch contact blocks as follows:

Max. Opertnl. Volts U_e	Utilization Category		Rated Operational Currents		
	IEC	NEMA	Volts U_e	Make	Break
AC 600	AC-15	B600	120...600	3600VA	360VA
			0...120	30 A	3 A
DC 300	DC-13	P300	24...300	138VA	
			0...24	5.0 A	

Stackable Sealed Switch Contact Ratings

Minimum: 5V, 10 mA (digital); 24V, 1 mA (analog)

Maximum continuous current I_{th} 2.5 A. Bulletin 800T units have control circuit ratings with sealed switch contact blocks as follows:

Max. Opertnl. Volts U_e	Utilization Category		Rated Operational Currents		
	IEC	NEMA	Volts U_e	Make	Break
AC 300	AC-15	C300	120...300	1800VA	180VA
			0...120	15 A	1.5 A
DC 150	DC-13	Q150	24...150	69VA	
			0...24	2.5 A	

Logic Reed Contact Ratings

Minimum — DC: 5V, 1 mA
 Maximum — DC: 30V, 0.06 A, AC: 150V, 0.15 A
 Should only be used with resistive loads.
 Electrical design life cycles: 200,000 (at max. rated load)

PenTUFF™ (Low Voltage) Contact Ratings

Minimum DC: 5V, 1 mA

Maximum thermal continuous current I_{th} 2.5 A AC/1.0 A DC. Bulletin 800T units with 800T-XAV contacts have ratings as follows:

Max. Opertnl. Volts U_e	Utilization Category		Rated Operational Currents		
	IEC	NEMA	Volts U_e	Make	Break
AC 300	AC-15	C300	120...300	1800VA	180VA
			0...120	15 A	1.5 A
DC 150	DC-13	R150	24...150	28VA	
			0...24	1.0 A	

Snap Action Contact Ratings

Max. Opertnl. Volts U_e	Contact Rating Designation	Rated Operational Currents		
		Volts U_e	Make	Break
AC 300	A300	120...300	7200VA	720VA
		24...72	60 A	10 A
DC 250	—	230...250	0.2 A	
		115...125	0.4 A	

MaxDuty Contact Rating

Maximum thermal continuous current I_{th} 24 A.
 Pilot Duty — 120V AC, 12 A; 24V DC, 10 A
 Motor Ratings — 120V AC, 1.5 Hp; 240V AC, 3 Hp; 24V DC, 10 A FLA/60 A LRA

Time Delay Contacts

Max. Opertnl. Volts U_e	Contact Rating Designation	Rated Operational Currents		
		Volts U_e	Make	Break
AC 120	B150	120	3600VA	360VA

Note: This device is not rated for DC applications.

Adjustment range: 0.5...15 s ± 25% I_{th} = 5 A

Materials Used in 800H Type 4X Operators

Thermoplastic Polyester (Fiberglass Reinforced)

- Bushings
- Mounting Rings
- Sockets

Transparent Amorphous Nylon

- Pilot light lens cap
- Illuminated button caps

Mineral Filled Nylon

- Trim washer

Thermoplastic Polyester

- Non-illuminated button caps

Glass Filled Crystalline Nylon

- Thrust washer

Nitrile (Synthetic Rubber)

- Gaskets and internal seals

Standards Compliance

UL 508
 CCC

Certifications

UL Listed
 (File No. E14840, E10314
 Guide No. NKCR, NOIV, NISD)
 CSA Certified
 (File No. LR1234, LR11924)
 CSA C22.2, No. 14
 CE Marked (EN/IEC 60947-5-1,
 EN/IEC 60947-5-5,
 EN ISO 13850)

DeviceNet Stations

Two-Unit

800T –

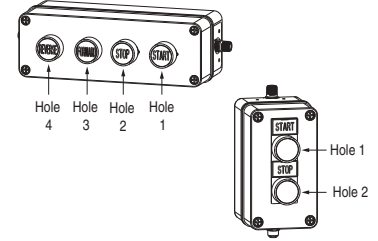
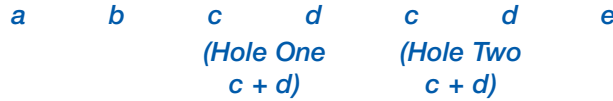

Three-Unit

800T –

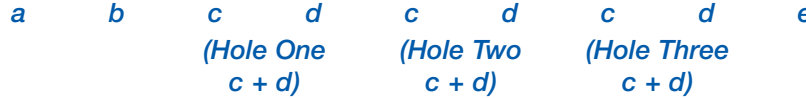

Four-Unit

800T –

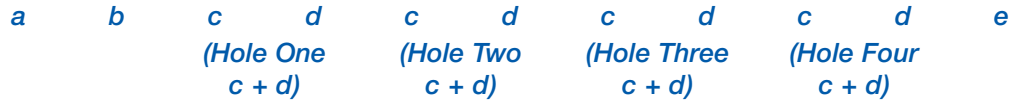

a

Orientation	
Code	Description
V	Vertical
H	Horizontal

b

Enclosure Style		
Grey Code	Description	Yellow Code
A	2-hole	K
B	3-hole	L
C	4-hole	M
G	E-stop only*	N

c

Operator Types	
Code	Description
A	Non-illuminated flush (800T-A*)
B	Non-illuminated extended (800T-B*)
C	Non-illuminated mushroom (800T-D*)
D	Illuminated mushroom (800T-QM*)
E	Illuminated extended (800T-QB*)
F	Illuminated guarded (800T-QA*)
G	2-position SS maintained (800T-H2*)
H	3-position SS maintained (800T-J2*)
J	Enhanced pilot light (800T-QH*)
K	Non-illuminated 2-position push/pull (800T-FX*)§
L	Non-illuminated push/pull twist-to-release (800T-FXT*)§
M	Illuminated 2-position push/pull (800T-FXQH*)
N	2-position key SS (800T-H33*)‡
P	3-position key SS (800T-J44*)‡
Q	2-position SS spring return from right (800T-H5*)
R	3-position SS spring return from all (800T-J91*)
T	Illuminated 2-position SS maintained (800T-24H*H*)
U	Illuminated 3-position SS maintained (800T-24J*H*)
V	Non-illuminated 3-position push/pull (800T-FXM*)
W	Potentiometer*

d

Color/Text	
Code	Description
1	Green
2	Black (non-illuminated only)
3	Orange (non-illuminated only)
4	Grey (non-illuminated only)
5	White
6	Red
7	Blue
8	Clear (illuminated only)
9	Yellow (non-illuminated)/amber (illuminated)
A	Green with Start legend
B	Red with Stop legend
C	Red with E-Stop legend
D	Black with Off/On legend
E	Black with Hand/Off/Auto legend
F	Red with Push to Stop/Pull to Start legend
G	Blue with Reset legend
H	Red with Power On legend
X	N/A (i.e. key ss)

e

External I/O Version*	
Code	Description
Blank	No external I/O
A	1 input/1 output (sinking)
B	1 input/1 output (sourcing)
C	2 input
E	2 output (sourcing)
F	1 E-stop blockΔ
G	2 E-stop blocksΔ
H	2 input + 2 input
K	2 input + 2 output (sourcing)
L	1 input/1 output (sinking) + 1 E-stop blockΔ
M	1 input/1 output (sourcing) + 1 E-stop blockΔ
N	1 input/1 output (sinking) + 2 E-stop blocksΔ
P	1 input/1 output (sourcing) + 2 E-stop blocksΔ
Q	2 input + 1 E-stop blockΔ
R	2 input + 2 E-stop blocksΔ
U	2 output (sourcing) + 1 E-stop blockΔ
W	2 output (sourcing) + 2 E-stop blocksΔ
X	2 input + 1 input/1 output (sinking)

‡ Operator Types N and P from Table c must choose Color/Text option X from Table d.
 § Operator Types K and L from Table c may be used as Emergency Stops. To be valid as an E-Stop, the operators must use Color/Text option C from Table d and it must be placed in the last hole position in the enclosure. An E-Stop connector also must be chosen from Table e.
 * Enclosure Style option G from Table b can only select one operator from Table c. Valid options are K and L with E-Stop.
 Δ External I/O Versions F, L, M, Q, and U receive only one contact block for the external E-Stop string. These connectors are rated to 3 A. If more than 3 A of current is needed or if there are two E-Stop strings, use External I/O Versions G, N, P, R, and W. These versions receive two contact blocks. This allows for 6 A of switching or for two E-Stop strings.
 ♦ This is an 8-in/4-out device. 2-in/1-out is assigned to each hole position in the enclosure. If a 2-hole enclosure is selected, 4-in and 2-out are assigned internally and up to 4 unassigned I/O points can be assigned to external connectors. This device contains up to two physical external I/O connectors. The "+" symbol in the Description field of Table e indicates that two external connectors exist. If an E-Stop connector is used, 2 unassigned I/O points can be assigned to the other connector.
 * Available for certain applications, please contact your local Allen-Bradley distributor.

2-Position Red Trigger Action Twist-to-Release, Non-Illuminated

- Tamper resistant – front-of-panel mounting and non-removable operator head
- Compliant with global E-stop standards, including EN ISO 13850 and EN 60947-5-5



Cat. No. 800T-TFXJET6



Cat. No. 800T-TFXLET6



Cat. No. 800T-TFXK6



Cat. No. 800H-TFRXT6

800 T - TFX T 6 D2
a *b* *c* *d* *e*

a

Protection Rating	
Code	Description
T	Metal, Type 4/13
H	Plastic, Type 4/4X/13

b

Finger-Safe Guards	
Code	Description
Blank	No guards
C	Guards on terminals

c

Head Type		
800T Type 4/13	Description	800H Type 4/4X/13
Code		Code
TFX	Standard (45 mm) mushroom head	TFRX
TFXJ	Jumbo (60 mm) mushroom head	TFRXJ
TFXJE	Jumbo (60 mm) mushroom head with "E-STOP"	TFRXJE
TFXK	45 mm mushroom head key release	—
TFXL	63 mm anodized aluminum head	—
TFXLE	63 mm anodized aluminum head with "E-STOP"	—

d

Release Function	
Code	Color
Blank	Key release ▲
T	Twist release

Note: X = Closed/O = Open
 ▲ Configurable only with **FXK** head type.

e

Contact Block(s)			
Code	Operator Position		Description
	Out	In	
Blank	—	—	No contacts on operator
Standard			
D2	X	O	1 N.C.
A	O	X	1 N.O. - 1 N.C.
A4	X	O	2 N.C.
PenTUFF (Low Voltage)			
D2V	X	O	1 N.C.
AV	O	X	1 N.O. - 1 N.C.

2-Position Red Trigger Action Twist-to-Release, Illuminated

- Tamper resistant – front-of-panel mounting and non-removable operator head
- Compliant with global E-stop standards, including EN ISO 13850 and EN 60947-5-5
- LED illumination provided as standard



Cat. No. 800T-TFXTS00R



Cat. No. 800T-TFXJETS00R



Cat. No. 800H-TFRXTS00R



Cat. No. 800H-TFRXJETS00R

800 T - TFXT
a b c

QH 2 R A
d e f

a

f

Protection Rating	
Code	Description
T	Metal, Type 4/13
H	Plastic, Type 4/4X/13

b

Finger-Safe Guards	
Code	Description
Blank	No guards
C	Guards on terminals

c

Head Type		
800T Type 4/13	Description	800H Type 4/4X/13
Code		Code
TFXT	Standard (45 mm) mushroom head	TFRXT
TFXJT	Jumbo (60 mm) mushroom head	TFRXJT
TFXJET	Jumbo (60 mm) mushroom head with "E-STOP"	TFRXJET

d

Illumination Option	
Code	Description
PH	Transformer with LED lamp
QH	Universal with LED lamp

e

Voltage	
Transformer	
Code	Description
16	120V AC 50/60 Hz
26	240V AC 50/60 Hz
46	480V AC 50/60 Hz
56	600V AC 50/60 Hz
Universal	
Code	Description
2	12...130V AC/DC

Target		
Contact		
N.O.	O	X
N.C./N.C.L.B./S.M.C.B.	X	O
Contact Blocks		
Code	Description	
Blank	No contacts	
Standard		
D2	1 N.C.	
D4S	1 S.M.C.B.	
A	1 N.O. - 1 N.C.	
G1	2 N.O. - 2 N.C.	
PenTUFF (Low Voltage)		
D2V	1 N.C.	
AV	1 N.O. - 1 N.C.	
G1V	2 N.O. - 2 N.C.	

Note: X = Closed/O = Open

Momentary Contact Push Button Devices, Non-Illuminated



Flush Head Unit
Cat. No. 800T-A1A



Extended Head Unit
Cat. No. 800T-B6A



Booted Unit
Cat. No. 800H-R2A



Bootless Flush Head Unit
Cat. No. 800H-AR1A

800 T - A 1 A
a b c d e f

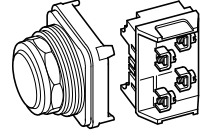

a

Protection Rating	
Code	Description
T	Metal, Type 4/13
H	Plastic, Type 4/4X/13

b

Finger-Safe Guards	
Code	Description
Blank	No guards
C	Guards on terminals

c

Operator Type		
800T Type 4/13	Description	800H Type 4/4X/13
Code		Code
A	Flush head	AR
B	Extended head	BR
D	Mushroom head	DR
DX	Mushroom head less color cap	DRX
—	Bootless guarded head	GR
—	Booted head	R★

d

Color Cap	
Code	Description
Blank	Used only when ordering Operator Type DX/DRX
1	Green
2	Black
3	Orange‡

d (cont'd)

Color Cap	
Code	Description
4	Grey‡
5	White‡
6	Red
7	Blue
9	Yellow

e

Special Mushroom Head	
Code	Description
J★	Jumbo mushroom head — plastic
L★	Jumbo mushroom head — metal

Note: Special mushroom head options only apply to mushroom head operator type code D/DR (Table c).

f

Contact Block(s)	
Code	Description
Blank	No contacts
Standard	
D1	1 N.O.
D2	1 N.C.
D3	1 N.O.E.M.
D4	1 N.C.L.B.
D5	1 N.O. (Mini)
D6	1 N.C. (Mini)
A1	1 N.C.L.B. - 1 N.O.
A2	2 N.O.§
A4	2 N.C.
A7	1 N.C.L.B. - 1 N.C.
A	1 N.O. - 1 N.C.
B	2 N.O. - 2 N.C.

f (cont'd)

Contact Block(s)	
Code	Description
PenTUFF (Low Voltage)	
D1V	1 N.O.
D2V	1 N.C.
D3V	1 N.O.E.M.
D4V	1 N.C.L.B.
AV	1 N.O. - 1 N.C.
BV	2 N.O. - 2 N.C.
Time Delay	
T	1 N.O. Depress close, delayed opening
S	1 N.C. Depress open, delayed closure
Snap Action	
M	1 N.O. - 1 N.C.
N	2 N.O. - 2 N.C.
Class 1, Div. 2	
Logic Reed	
D1R	1 N.O.
D2R	1 N.C.
A2R	2 N.O.§
A4R	2 N.C.
AR	1 N.O. - 1 N.C.
BR	2 N.O. - 2 N.C.

f (cont'd)

Contact Block(s)	
Code	Description
Class 1, Div. 2	
Sealed Switch	
D1P	1 N.O.
D2P	1 N.C.
AP	1 N.O. - 1 N.C.
BP	2 N.O. - 2 N.C.
Stackable Sealed Switch	
D1Y	1 N.O.
D2Y	1 N.C.
A2Y	2 N.O.
A4Y	2 N.C.
AY	1 N.O. - 1 N.C.
BY	2 N.O. - 2 N.C.
Time Delay Contacts	
Series C field installable kits can only be used with Series T or later operators. Adjustable range of 0.5 to 15 s + 25%. Maximum continuous current I _{th} 5 A.	
Snap Action Contacts	
Snap-action contacts feature a quick make, quick break snap-action mechanism that is only available on factory assembled units. Maximum continuous current I _{th} 10 A.	

- ★ Underlying operators are extended head. Boot material is chlorosulfonated polyethylene.
- ‡ Not available for booted operators.
- § A2 and A2R contact blocks cannot be stacked upon, but can stack on other contact blocks.
- ▲ Jumbo mushroom heads not available in white color.

Momentary Contact Push Button Devices, Illuminated



Extended Head Without Guard
Cat. No. 800T-PB16R



Extended Head without Guard
Cat. No. 800H-PRB16R

800 T - P B H 16 R
 a b c d e f g h

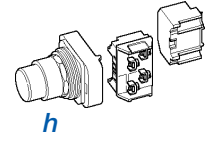

a

Protection Rating	
Code	Description
T	Metal, Type 4/13
H	Plastic, Type 4/4X/13

b

Finger-Safe Guards	
Code	Description
Blank	No guards
C	Guards on terminals

c

Power Module Type		
800T Type 4/13	Description	800H Type 4/4X/13
Code		Code
P	Transformer (or dual input)	PR
Q	Full voltage/Universal	QR

d

Head Type	
Code	Description
A	Extended head with guard
B	Extended head without guard
M	Mushroom
MJ	Jumbo mushroom

e

Illumination Options	
Code	Description
Blank	Incandescent
H	LED
Dual Input	
D	Diode type§
T	Transformer — relay type
TH	Transformer — relay type LED

f

Voltage	
Transformer	
Code	Description
16	120V AC, 50/60 Hz
26	240V AC, 50/60 Hz
46	480V AC, 50/60 Hz
56	600V AC, 50/60 Hz
Full Voltage — Incandescent	
12	12V AC/DC
24	24V AC/DC
48	48V AC/DC
10	120V AC/DC
20	240V AC/DC
Universal — LED	
2	12...130V AC/DC
Dual Input	
16	120V AC
24	24V AC/DC♦

g

Lens Color	
Code	Description
Blank	No lens with standard contacts 1 N.O. - 1 N.C.
X	No lens if ordering any contacts other than standard 1 N.O. - 1 N.C.
A	Amber
B	Blue
C	Clear
G	Green
R	Red
W	White

h

Contact Block(s)	
Code	Description
X	No contacts
Standard	
Blank	1 N.O. - 1 N.C.
D1	1 N.O.
PenTUFF (Low Voltage)	
AV	1 N.O. - 1 N.C.
Class 1, Div. 2	
Logic Reed	
AR	1 N.O. - 1 N.C.
Sealed Switch	
AP	1 N.O. - 1 N.C.
Stackable Sealed Switch	
AY	1 N.O. - 1 N.C.

§ Diode type dual input provides circuit isolation via opposing diodes. Not recommended for use with solid-state outputs.

♦ Dual input diode only.

Momentary Contact Push Button Devices, Non-Illuminated — With Two-Color Molded Legend Caps



Cat. No. 800T-A00 with Cat. No. 800T-LC103W installed



Cat. No. 800H-BR00 with Cat. No. 800T-LC604 installed

800 T - A 103W A
a b c d e

a

Protection Rating	
Code	Description
T	Metal, Type 4/13
H	Plastic, Type 4/4X/13

b

Finger-Safe Guards	
Code	Description
Blank	No guards
C	Guards on terminals

c

Operator Type		
800T Type 4/13	Description	800H Type 4/4X/13
Code		Code
A	Flush head	AR
B	Extended head	BR

d

Cap Text/Color			
Code	Text	Color	
		Cap	Text
101W	I	Green	White
103W	START		
105W	ON		
121W	START / I		
202W	O		
204W	STOP		
207W	RESET		
208W	↑		
209W	FORWARD		
210W	REVERSE		
212W	JOG	Black	White
213W	UP		
214W	DOWN		
215W	RAISE		
216W	LOWER		
217W	IN		
218W	OUT		
219W	HIGH		
220W	LOW		
222W	STOP / O		
501B	I	White	Black
503B	START		
508B	↑		
521B	START / I		
602W	O	Red	White
604W	STOP		
606W	OFF		
622W	STOP / O		
707W	RESET	Blue	White
711W	R		

e

Contact Block(s)	
Code	Description
Blank	No contacts
Standard	
D1	1 N.O.
D2	1 N.C.
D3	1 N.O.E.M.
D4	1 N.C.L.B.
D5	1 N.O. (Mini)
D6	1 N.C. (Mini)
A1	1 N.C.L.B. - 1 N.O.
A2	2 N.O.§
A4	2 N.C.
A7	1 N.C.L.B. - 1 N.C.
A	1 N.O. - 1 N.C.
B	2 N.O. - 2 N.C.
Class 1, Div. 2	
Sealed Switch	
D1P	1 N.O.
D2P	1 N.C.
AP	1 N.O. - 1 N.C.
BP	2 N.O. - 2 N.C.
Stackable Sealed Switch	
D1Y	1 N.O.
D2Y	1 N.C.
A2Y	2 N.O.
A4Y	2 N.C.
AY	1 N.O. - 1 N.C.
BY	2 N.O. - 2 N.C.

e (cont'd)

Contact Block(s)	
Code	Description
PenTUFF (Low Voltage)	
D1V	1 N.O.
D2V	1 N.C.
D3V	1 N.O.E.M.
D4V	1 N.C.L.B.
AV	1 N.O. - 1 N.C.
BV	2 N.O. - 2 N.C.
Time Delay	
T	1 N.O. Depress close, delayed opening
S	1 N.C. Depress open, delayed closure
Snap Action	
M	1 N.O. - 1 N.C.
N	2 N.O. - 2 N.C.
Class 1, Div. 2	
Logic Reed	
D1R	1 N.O.
D2R	1 N.C.
A2R	2 N.O.§
A4R	2 N.C.
AR	1 N.O. - 1 N.C.
BR	2 N.O. - 2 N.C.

§ A2 and A2R contact blocks cannot be stacked upon, but can stack upon other contact blocks.

2-Position Selector Switch Devices, Non-Illuminated



Standard Knob Operator
Cat. No. 800T-H2A



Knob Lever Operator
Cat. No. 800T-H17A



Standard Knob Operator
Cat. No. 800H-HR2A

800 T - HA 2 A
a b c d e

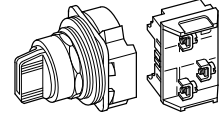

a

Protection Rating	
Code	Description
T	Metal, Type 4/13
H	Plastic, Type 4/4X/13

b

Finger-Safe Guards	
Code	Description
Blank	No guards
C	Guards on terminals

c

Knob Insert Colors		
800T Type 4/13	Description	800H Type 4/4X/13
Code		Code
H	White	HR
HX	Packet of colored inserts‡	HRX
Metal Wing Lever Colors*		
Code	Color	Code
HA	Red	—
HG	Grey	—

d

Operator Type and Function	
Standard Knob	
Code	Operator Function
2	Maintained
4	Spring return from left§
5	Spring return from right
Knob Lever*	
Code	Operator Function
17	Maintained
18	Spring return from left§
19	Spring return from right
Metal Wing Lever*	
Code	Operator Function
11	Maintained
15	Spring return from left§
16	Spring return from right
Coin Slot*	
Code	Operator Function
6	Maintained
7	Spring return from left
8	Spring return from right

e

Contact Block(s)			
Code	Contact Configuration	2-Position	
Blank	No contacts	—	—
Standard			
D1	1 N.O.	O	X
D2	1 N.C.	X	O
A	1 N.O. - 1 N.C.	O	X
		X	O
B	2 N.O. - 2 N.C.	O	X
		X	O
		O	X
D1M	1 N.O.	—	
		—	
D2M	1 N.C.	—	
		—	
PenTUFF (Low Voltage)Δ			
D1V	1 N.O.	—	
D2V	1 N.C.	—	
AV	1 N.O. - 1 N.C.	—	
BV	2 N.O. - 2 N.C.	—	
Class1, Div. 2			
Logic ReedΔ			
D1R	1 N.O.	—	
D2R	1 N.C.	—	
AR	1 N.O. - 1 N.C.	—	
BR	2 N.O. - 2 N.C.	—	
Sealed SwitchΔ			
D1P	1 N.O.	—	
D2P	1 N.C.	—	
AP	1 N.O. - 1 N.C.	—	
BP	2 N.O. - 2 N.C.	—	
Stackable Sealed SwitchΔ			
D1Y	1 N.O.	—	
D2Y	1 N.C.	—	
AY	1 N.O. - 1 N.C.	—	
BY	2 N.O. - 2 N.C.	—	

‡ One insert of each color (blue, green, orange, red, and yellow).
 § Target tables are reversed from those shown.
 * Only available on Bul. 800T, Type 4/13 operators.
 Δ Contact target tables same as those listed for standard contact blocks.

2-Position Selector Switch Devices, Non-Illuminated (Bul. 800T only)



2-Position Cylinder Lock Operator
Cat. No. 800T-H33A

800 T - H31 A
a b c d e

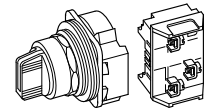

a

Protection Rating	
Code	Description
T	Metal, Type 4/13

b

Finger-Safe Guards	
Code	Description
Blank	No guards
C	Guards on terminals

c

Key Removal Position	
Maintained	
Code	Operator Function
H31	Key removal — left
H32	Key removal — right
H33	Key removal — both
Spring Return From Left	
Code	Operator Function
H42	Key removal — right ★
Spring Return From Right	
Code	Operator Function
H48	Key removal — left

d

Key Options for Cylinder Locks Δ			
Code	T Series Key No.	Code	T Series Key No.
Blank	D018 (Std. Key)	15	T112
03	D020	16	T115
04	D025	17	T324
05	D335	18	T382
06	D429	19	T404
07	D461	20	T171
08	D111	21	T484
09	D587	22	T547
10	D682	23	T569
11	D713	24	T692
12	D900	25	T752
13	D992	26	T178
14	D118	—	—

e

Contact Block(s)			
Code	Contact Configuration	Description	
		2-Position	
Blank	No contacts	—	—
Standard			
D1	1 N.O.	O	X
D2	1 N.C.	X	O
A	1 N.O. - 1 N.C.	O	X
		X	O
B	2 N.O. - 2 N.C.	O	X
		X	O
		O	X
		X	O
Max Duty (Horsepower Rated)			
D1M	1 N.O.		
D2M	1 N.C.		
PenTUFF (Low Voltage)			
D1V	1 N.O.		
D2V	1 N.C.		
AV	1 N.O. - 1 N.C.		
BV	2 N.O. - 2 N.C.		
Class1, Div. 2			
Logic Reed \clubsuit			
D1R	1 N.O.		
D2R	1 N.C.		
AR	1 N.O. - 1 N.C.		
BR	2 N.O. - 2 N.C.		
Sealed Switch \clubsuit			
D1P	1 N.O.		
D2P	1 N.C.		
AP	1 N.O. - 1 N.C.		
BP	2 N.O. - 2 N.C.		
Stackable Sealed Switch \clubsuit			
D1Y	1 N.O.		
D2Y	1 N.C.		
AY	1 N.O. - 1 N.C.		
BY	2 N.O. - 2 N.C.		

★ Target tables are reversed from those shown.

\clubsuit Contact target tables same as those listed for standard and PenTUFF contact blocks.

Δ Device supplied with 2 keys. Replacement key part no. for standard D018 key is X-181170. Consult your local Rockwell Automation sales office or Allen-Bradley distributor for additional replacement key numbers.

4-Position Selector Switch Devices, Non-Illuminated



Standard Knob Operator
Cat. No. 800T-N2KN4B



Knob Lever Operator
Cat. No. 800T-N17KN4B



Standard Knob Operator
Cat. No. 800H-NR2KF4AAXX

800 T - N 2 KF4 B
a b c d e f

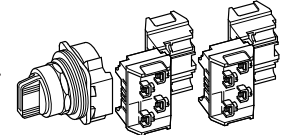

a

Protection Rating	
Code	Description
T	Metal, Type 4/13
H	Plastic, Type 4/4X/13

b

Finger-Safe Guards	
Code	Description
Blank	No guards
C	Guards on terminals

c

Knob Insert Colors		
800T Type 4/13	Description	800H Type 4/4X/13
Code		Code
N	White	NR
NX	Packet of colored inserts★	NRX

Metal Wing Lever Colors		
Code	Color	Code
NA	Red	—
NG	Grey	—

d

Operator Function and Knob Type	
Standard Knob	
Code	Operator Function
2	Maintained
3	Spring return from position 1 to position 2
9	Spring return from position 4 to position 3

Knob Lever*	
Code	Operator Function
17	Maintained
29	Spring return from position 1 to position 2
30	Spring return from position 4 to position 3

Metal Wing Lever*	
Code	Operator Function
11	Maintained
13	Spring return from position 1 to position 2
14	Spring return from position 4 to position 3

e

Cam OptionΔ	
Code	Description
KF4	F cam
KG4	G cam
KK4♦	K cam
KM4♦	M cam
KP4	P cam
KN4	Overlapping cam‡

f

Contact BlocksΔ		
800T Type 4/13	Description	800H Type 4/4X/13
Code		Code
Blank	No contacts	Blank

Standard		
Code	Description	Code
B	2 N.O. - 2 N.C. 2-800T-XAs — 1 on white side/ 1 on black side	AAXX
H	3 N.O. - 3 N.C. 3-800T-XAs — 2 on white side/ 1 on black side	AAAX
C	4 N.O. - 4 N.C. 4-800T-XAs — 2 on white side/ 2 on black side	AAAA

f (cont)

Contact Blocks		
800T Type 4/13	Description	800H Type 4/4X/13
Code		Code
PenTUFF (Low Voltage)		
BV	2 N.O. - 2 N.C.	FFXX
HV	3 N.O. - 3 N.C.	FFFX
CV	4 N.O. - 4 N.C.	FFFF
Class 1, Div. 2		
Logic Reed§		
BR	2 N.O. - 2 N.C.	TTXX
HR	3 N.O. - 3 N.C.	TTTX
CR	4 N.O. - 4 N.C.	TTTT
Sealed Switch§		
BP	2 N.O. - 2 N.C.	PPXX
Stackable Sealed Switch*		
BYΔ	2 N.O. - 2 N.C.	TTXX
HYΔ	3 N.O. - 3 N.C.	TTTX
CYΔ	4 N.O. - 4 N.C.	TTTT

- ★ One insert of each color (blue, green, orange, red, and yellow).
- ‡ Overlapping cam. See Publication 800T-2.8 for overlap specifications.
- § Contact block mounting same as listed for standard and PenTUFF contact blocks.
- * Only available on Bul. 800T, Type 4/13 operators.
- Δ See Table 1 for proper cam/contact selection.
- ♦ Not available with wing levers.

Table 1. Cam and Contact Block Functionality Table

Contact Block Suffix Code	Contact Block Side	Circuits	Cam Codes																								
			KF4				KG4				KK4				KM4				KP4				KN4‡				
			↺	↻	↻	↺	↺	↻	↻	↺	↺	↻	↻	↺	↺	↻	↻	↺	↺	↻	↻	↺	↺	↻	↻	↺	
	White	A	X	O	O	O	X	X	O	O	O	O	X	X	X	O	O	O	O	O	O	X	O	X	O	O	
		B	O	X	O	O	O	O	X	O	X	X	O	O	O	X	X	O	O	X	O	O	O	O	O	O	X
	Black	A	O	O	O	X	X	O	O	O	X	O	O	X	O	O	O	X	O	O	X	X	O	O	X	O	O
		B	O	O	X	O	O	O	O	X	O	X	X	O	O	X	O	O	X	O	O	O	O	X	O	O	O
	White	A	X	O	O	O	X	X	O	O	O	O	X	X	X	O	O	O	O	O	O	X	O	X	O	O	O
		B	O	X	O	O	O	O	X	O	X	X	O	O	O	X	X	O	O	X	O	O	O	O	O	O	X
	Black	A	O	O	O	X	X	O	O	O	X	O	O	X	O	O	O	X	O	O	X	X	O	O	X	O	O
		B	O	O	X	O	O	O	O	O	X	O	X	X	O	O	X	O	O	X	O	O	O	X	O	O	O

Note: X = Closed/O = Open

4-Position Selector Switch Devices, Non-Illuminated (800T only)



Cylinder Lock Operator
Cat. No. 800T-N32KF4B

800 T - N31 KM4 C
a b c d e f

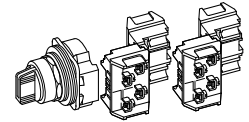

a

Protection Rating	
Code	Description
T	Metal, Type 4/13

b

Finger-Safe Guards	
Code	Description
Blank	No guards
C	Guards on terminals

c

Key Removal Position and Operator Function	
Maintained	
Code	Operator Function
N31	Key removal position 1
N32	Key removal position 2
N33	Key removal position 3
N34	Key removal position 4
N61	Key removal all positions

c (cont'd)

Key Removal Position and Operator Function	
Spring Return From Position 1 to Position 2	
Code	Description
N132	Key removal position 2
N133	Key removal position 3
N134	Key removal position 4
N154	Key removal positions 2, 3, and 4
Spring Return From Position 4 to Position 3	
Code	Operator Function
N231	Key removal position 1
N232	Key removal position 2
N233	Key removal position 3
N251	Key removal positions 1, 2, and 3

d

Key Options for Cylinder Locks*	
D Series	
Code	Key No.
Blank	D018 (standard key)
03	D020
04	D025
05	D335
06	D429

Note: Refer to page 11 for additional key option codes.

e

Cam Option	
Code	Description
KF4	F cam
KG4	G cam
KK4	K cam
KM4	M cam
KP4	P cam
KN4	Overlapping cam†

Note: See Table 1 for proper cam selection.

f

Contact Blocks	
Code	Description
Blank	No contacts
Standard	
B	2 N.O. - 2 N.C. 2-800T-XAs — 1 on white side/1 on black side
H	3 N.O. - 3 N.C. 3-800T-XAs — 2 on white side/1 on black side
C	4 N.O. - 4 N.C. 4-800T-XAs — 2 on white side/2 on black side
PenTUFF (Low Voltage)	
BV	2 N.O. - 2 N.C. 2-800T-XAVs — 1 on white side/1 on black side
HV	3 N.O. - 3 N.C. 3-800T-XAVs — 2 on white side/1 on black side
CV	4 N.O. - 4 N.C. 4-800T-XAVs — 2 on white side/2 on black side
Class 1, Div. 2	
Logic Reed§	
BR	2 N.O. - 2 N.C.
HR	3 N.O. - 3 N.C.
CR	4 N.O. - 4 N.C.
Sealed Switch§	
BP	2 N.O. - 2 N.C.
Stackable Sealed Switch§	
BY	2 N.O. - 2 N.C.
HY	3 N.O. - 3 N.C.
CY	4 N.O. - 4 N.C.

Note: Associated targets shown in Table 1.

Note: X = Closed/O = Open
 † Overlapping cam. One layer of contact blocks allowed, no stacking. See Publication 800T-2.8 for overlap specifications.
 § Contact block mounting same as listed for standard and PenTUFF contact blocks.
 * Device supplied with 2 keys. Replacement key part no. for standard D018 key is X-181170. Consult your local Rockwell Automation sales office or Allen-Bradley distributor for additional replacement key numbers.

Table 1. Cam and Contact Block Functionality Table

Contact Block Suffix Code	Contact Block Side	Circuits	Cam Codes																							
			KF4				KG4				KK4				KM4				KP4				KN4†			
			↙	↘	↙	↘	↙	↘	↙	↘	↙	↘	↙	↘	↙	↘	↙	↘	↙	↘	↙	↘				
C	White	A	X	O	O	O	X	X	O	O	O	O	X	X	X	O	O	O	O	O	O	X	O	X	O	O
		B	O	X	O	O	O	O	X	O	X	X	O	O	O	X	X	O	O	X	O	O	O	O	O	O
	Black	A	O	O	O	X	X	O	O	O	X	O	O	X	O	O	O	X	O	O	X	X	O	O	X	O
		B	O	O	X	O	O	O	O	X	O	X	X	O	O	X	O	O	X	O	O	O	O	X	O	O
H	White	A	X	O	O	O	X	X	O	O	O	O	X	X	X	O	O	O	O	O	O	X	O	X	O	O
		B	O	X	O	O	O	O	X	O	X	X	O	O	O	X	X	O	O	X	O	O	O	O	O	X
	Black	A	O	O	O	X	X	O	O	O	X	O	O	X	O	O	O	X	O	O	X	X	O	O	X	O
		B	O	O	X	O	O	O	O	X	O	X	X	O	O	X	O	O	X	O	O	O	O	X	O	O

2-Position Knob/Lever Type Selector Switch Devices, Illuminated



Standard Knob Operator
Cat. No. 800T-16HR2KB6AX



Knob Lever Operator
Cat. No. 800H-16HRR17KB6AX

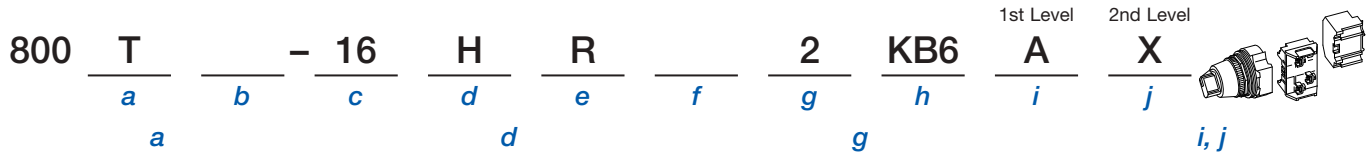

a

Protection Rating	
Code	Description
T	Metal, Type 4/13
H	Plastic, Type 4/4X/13

b

Finger-Safe Guards	
Code	Description
Blank	No guards
C	Guards on terminals

c

Power Module Type and Voltage	
Full Voltage — Incandescent	
Code	Description
12	12V AC/DC
24	24V AC/DC
48	48V AC/DC

Universal — LED	
Code	Description
2	12...130V AC/DC

Transformer	
Code	Description
16	120V AC 50/60 Hz
26	240V AC 50/60 Hz

For other voltages, please consult your local Rockwell Automation sales office or Allen-Bradley distributor.

d

No. of Positions		
Bul. 800T Type 4/13	Description	Bul. 800H Type 4/4X/13
Code		Code
H	2-position	HR

e

Knob Color	
Code	Color
A	Amber
B	Blue
C	Clear
G	Green
R	Red
W	White
X	No knob

f

Illumination Options	
Code	Description
Blank	Incandescent
H	LED

Table 1. Selector Switch Cam Targets

Cam Description (2-Position)		
Target		Contact Block Code▲
O	X	D, H, V, R, 5
X	O	E, U, W, S, 6

X = Closed/O = Open

g

Operator Function and Knob Type	
Standard Knob or No Knob	
Code	Operator Function
2	Maintained
4	Spring return from left
5	Spring return from right

Knob Lever	
Code	Operator Function
17	Maintained
18	Spring return from left
19	Spring return from right

h

Cam Options	
2-Position	
Code	Operator Function
KB6	Maintained cam
KL8	Spring return cam

Table 2. Contact Block Code Reduction Rules

Contact Block Substitution	
Combination	Code
Standard	
D + E	A
D + D	M
E + E	N

i, j

Contact Blocks▲	
Code	Description
Blank (both pos.)	No contacts
Standard	
D	1 N.O.
E	1 N.C.
A	1 N.O. - 1 N.C.
X	No contacts in this position
PenTUFF (Low Voltage)	
H	1 N.O.
U	1 N.C.
F	1 N.O. - 1 N.C.
Class 1, Div. 2	
Logic Reed	
V	1 N.O.
W	1 N.C.
T	1 N.O. - 1 N.C.
Sealed Switch	
R	1 N.O.
S	1 N.C.
P	1 N.O. - 1 N.C.
Stackable Sealed Switch	
5	1 N.O.
6	1 N.C.
7	1 N.O. - 1 N.C.

▲ Contact blocks used on white side only.

◆ Target tables are reversed for spring return from left operators.

3-Position Knob/Lever Type Selector Switch Devices, Illuminated



Standard Knob Operator
Cat. No. 800T-16JR2KB7AX



Standard Knob Operator
Cat. No. 800H-16JRR2KB7AX

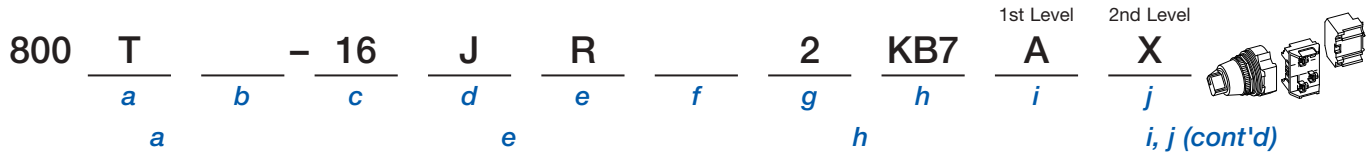

a

Protection Rating	
Code	Description
T	Metal, Type 4/13
H	Plastic, Type 4/4X/13

b

Finger-Safe Guards	
Code	Description
Blank	No guards
C	Guards on terminals

c

Power Module Type and Voltage	
Full Voltage — Incandescent	
Code	Description
12	12V AC/DC
24	24V AC/DC
48	48V AC/DC
Universal — LED	
2	12...130V AC/DC
Transformer	
16	120V AC 50/60 Hz
26	240V AC 50/60 Hz
For other voltages, please consult your local Rockwell Automation sales office or Allen-Bradley distributor.	

d

No. of Positions		
800T Type 4/13	Description	800H Type 4/4X/13
Code		Code
J	3-position	JR

e

Knob Color	
Code	Color
A	Amber
B	Blue
C	Clear
G	Green
R	Red
W	White
X	No knob

f

Illumination Options	
Code	Description
Blank	Incandescent
H	LED§

g

Operator Function and Knob Type	
Standard Knob or No Knob	
Code	Operator Function
2	Maintained
4	Spring return from left
5	Spring return from right
91	Spring return from both
Knob Lever	
Code	Operator Function
17	Maintained
18	Spring return from left
19	Spring return from right
20	Spring return from both

h

Cam Options	
3-Position	
Code	Operator Function
KB7	B7 cam
KC1	C1 cam
KC7	C7 cam
KE7	E7 cam
KQ1	Q1 cam
KT1	T1 cam

i, j

Contact Blocks*	
Code	Description
Blank (both pos.)	No contacts

i, j (cont'd)

Contact Blocks*	
Code	Description
Standard	
A	1 N.O. - 1 N.C.
X	No contacts in this position
PenTUFF (Low Voltage)	
F	1 N.O. - 1 N.C.
Class 1, Div. 2	
Logic Reed	
T	1 N.O. - 1 N.C.
Sealed Switch	
P	1 N.O. - 1 N.C.
Stackable Sealed Switch	
7	1 N.O. - 1 N.C.

Table 1. Selector Switch Cam Targets

Target			Cam Description (3-Position)					
			KB7	KC1	KC7	KE7	KQ1	KT1
X	O	O	D, H, V, R, 5	—	D, H, V, R, 5	D, H, V	—	E, U, W, S, 6
O	X	O	—	E, U, W, S, 6	E, U, W, S, 6	—	E, U, W, S, 6	—
O	O	X	E, U, W, S, 6	D, H, V, R, 5	—	—	—	D, H, V, R, 5
X	X	O	G, I	J, Q	—	—	—	J, Q
O	X	X	J, Q	—	J, Q	E, U, W, S, 6	—	—
X	O	X	—	G, I	G, I	—	D, H, V, R, 5	—

§ LEDs available in red, green, amber, blue, and white. White LEDs only available in 6V, 24V, 120V, and 130V full voltage and all transformer units. LED color matches lens color, except clear lens supplied with white LED and white lens supplied with amber LED. All LEDs except 120V have an internal shunt resistor for use with solid-state outputs.

* Contact blocks used on white side only.

Pilot Light Devices



Transformer Type Pilot Light
Cat. No. 800T-P16R



Push-to-Test Pilot Light
Cat. No. 800T-PT16R

800 T - P T 16 G AR (Push-to-Test)

a b c d e f g h

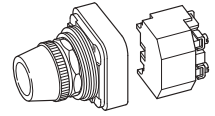

a

Protection Rating	
Code	Description
T	Metal, Type 4/13
H	Plastic, Type 4/4X/13

b

Finger-Safe Guards	
Code	Description
Blank	No guards
C	Guards on terminals

c

Power Module Type		
800T Type 4/13	Description	800H Type 4/4X/13
Code		Code
P	Transformer (or dual input)	PR
Q	Full voltage/Universal	QR

d

Lamp Test Options	
Code	Description
Blank	No test option ▽
T	Push-to-test
D	Dual input — diode ▲
DT	Dual input — transformer relay ♣

Note: Push-to-test supplied with factory jumpered contact block.

e

Illumination Options	
Code	Description
Blank	Incandescent
H	LED ♣

f

Voltage	
Transformer	
Code	Description
16	120V AC 50/60 Hz
26	240V AC 50/60 Hz
46	480V AC 50/60 Hz
56	600V AC 50/60 Hz
Full Voltage — Incandescent	
12	12V AC/DC
24	24V AC/DC
48	48V AC/DC
10	120V AC/DC
20	240V AC/DC
Universal — LED	
2	12...130V AC/DC
Dual Input	
16	120V AC
24	24V AC/DC (Dual input diode only)

g

Lens Color		
Code	Color	Glass Code #
Blank	No lens	Blank
A	Amber	D
B	Blue	E
C	Clear	F
G	Green	H
R	Red	J
W	White	K

h

Contact Blocks (Push-to-test units only)	
Code	Description
Standard	
Blank	1 N.O. - 1 N.C.
PenTUFF (Low Voltage)	
AV	1 N.O. - 1 N.C.
Class 1, Div. 2	
Logic Reed	
AR	1 N.O. - 1 N.C.
Sealed Switch	
AP	1 N.O. - 1 N.C.
Stackable Sealed Switch	
AY	1 N.O. - 1 N.C.

- ▽ Non-push-to-test pilot lights using the universal LED option cannot be ordered as Bul. 800HC or 800TC. The terminals are finger-safe as standard.
- ▲ Diode type dual input provides circuit isolation via opposing diodes. Not recommended for use with solid-state outputs.
- ♣ Dual input devices (diode or transformer type) cannot be ordered as Bul. 800HC or 800TC. Finger-safe terminal guards are not available.
- ♣ LED illumination option is not available with diode type dual input.
- # Glass lens available on 800T pilot lights only. Not available on push-to-test units.

2-Position Push-Pull and Push-Pull/Twist Release Devices, Non-Illuminated

Note: A jumbo or large legend plate is recommended, if space allows.



2-Position Push-Pull
Cat. No. 800T-FX6D4



2-Position Metal Push-Pull
Cat. No. 800TC-FXLE6D4S



2-Position Push-Pull / Twist
Cat. No. 800T-FXT6D4



2-Position Push-Pull / Twist
Cat. No. 800H-FRXT6D4

800 T - FX 1 A1
a b c d e

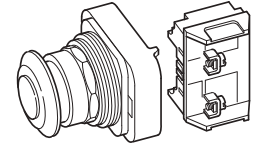

a

Protection Rating	
Code	Description
T	Metal, Type 4/13
H	Plastic, Type 4/4X/13

b

Finger-Safe Guards	
Code	Description
Blank	No guards
C	Guards on terminals

c

Head Type §		
800T Type 4/13	Description	800H Type 4/4X/13
Code		Code
FX	Mushroom head (push-pull)	—
FXC	90 mm anodized aluminum head (push-pull)	—
FXJ	Jumbo mushroom head (push-pull)	—
FXJE	Jumbo mushroom head (push-pull) with "E-Stop"	—
FXL	63 mm anodized aluminum head (push-pull)	—
FXLE	63 mm anodized aluminum head (push-pull) with "E-Stop"	—
FXT	Push-pull/twist-to-release	FRXT
FXJT	Jumbo head push-pull with twist-to-release	FRXJT

d

Color Cap	
Code	Color
Blank	No cap ♣
1	Green
2	Black
3	Orange
4	Grey
5	White
6	Red
7	Blue
9	Yellow

e

Contact Block(s)			
Code	Operator Position		Description
	Out	In	
Blank	—	—	No contacts on operator
Standard			
D1	O	X	1 N.O.
D2	X	O	1 N.C.
D4	X	O	1 N.C.L.B. ★
A	O	X	1 N.O. - 1 N.C.
A1	O	X	1 N.O. - 1 N.C.L.B. ★
A5	X	O	2 N.C.L.B. ▽★

e (cont'd)

Contact Block(s)			
Code	Operator Position		Description
	Out	In	
Blank	—	—	No contacts
PentUFF (Low Voltage)			
D1V	O	X	1 N.O.
D2V	X	O	1 N.C.
D4V	X	O	1 N.C.L.B.
AV	O	X	1 N.O. - 1 N.C.
X	X	O	1 N.O. - 1 N.C.
Class 1, Div. 2			
Logic Reed			
D1R	O	X	1 N.O.
D2R	X	O	1 N.C.
AR	O	X	1 N.O. - 1 N.C.
X	X	O	1 N.O. - 1 N.C.
Sealed Switch			
D1P	O	X	1 N.O.
D2P	X	O	1 N.C.
AP	O	X	1 N.O.
X	X	O	1 N.C.
Stackable Sealed Switch			
D1Y	O	X	1 N.O.
D2Y	X	O	1 N.C.
AY	O	X	1 N.O. - 1 N.C.
X	X	O	1 N.O. - 1 N.C.

Note: X = Closed/O = Open

★ Normally closed late break contact. When button is pushed from the OUT to IN position, the mechanical detent action of the operator occurs before electrical contacts change state. When the button is pulled from the IN in the OUT position, the electrical contacts change state before the mechanical detent occurs.

§ Devices with N.C.L.B. contacts meet EN ISO 13850 and IEC 60947-5-5 standards for emergency stop applications.

♣ Not valid with head Type J or JT.

▽ Two 800T-XD4 contact blocks supplied.

3-Position Push-Pull Devices, Non-Illuminated

Note: A jumbo or large legend plate is recommended, if space allows.



3-Position Push-Pull
Cat. No. 800T-FXM6A7



3-Position Push-Pull
Cat. No. 800H-FRXM6A7

800 T - FX M 1 A7
a b c d e f

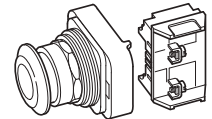

a

Protection Rating	
Code	Description
T	Metal, Type 4/13
H	Plastic, Type 4/4X/13

b

Finger-Safe Guards	
Code	Description
Blank	No guards
C	Guards on terminals

c

Head Type		
800T Type 4/13	Description	800H Type 4/4X/13
Code		Code
FX	Mushroom head (push-pull)	FRX
FXC	90 mm anodized aluminum head (push-pull)	—
FXJ	Jumbo mushroom head (push-pull)	FRXJ
FXL	63 mm anodized aluminum head (push-pull)	—

d

Operator Function			
Code	Operator Position		
	Out	Center	In
M	Momentary	Maintained	Maintained
N	Momentary	Maintained	Momentary

e

Color Cap	
Code	Color
Blank	No cap §
1	Green
2	Black
3	Orange
4	Grey
5	White
6	Red
7	Blue
9	Yellow

f

Contact Block(s)				
Code	Operator Position			Description
	Out	Ctr.	In	
Blank	—	—	—	No contacts
Standard				
A	O	O	X	1 N.O. - 1 N.C.
A1	O	O	X	1 N.O. - 1 N.C.L.B.
A7	X	O	O	1 N.C. - 1 N.C.L.B.
B6	X	O	O	2 N.C. - 2 N.C.L.B.
	X	X	O	
	X	O	O	
	X	X	O	
PenTUFF (Low Voltage)				
AV	O	O	X	1 N.O. - 1 N.C.
	X	O	O	

f (cont'd)

Contact Block(s)				
Code	Operator Position			Description
	Out	Ctr.	In	
Class 1, Div. 2				
Logic Reed				
AR	O	O	X	1 N.O. - 1 N.C.
	X	O	O	
Sealed Switch				
AP	O	O	X	1 N.O. - 1 N.C.
	X	O	O	
Stackable Sealed Switch				
AY	O	O	X	1 N.O. - 1 N.C.
	X	O	O	

Note: X = Closed/O = Open
§ Not valid with head Type J.

2-Position Push-Pull and Push-Pull/Twist Release Devices, Illuminated

Note: A jumbo or large legend plate is recommended, if space allows.



Illuminated 2-Position Push-Pull
Cat. No. 800T-FXP16RA1



2-Position Push-Pull
Cat. No. 800T-FXJEP16RA1



Illuminated 2-Position Push-Pull/Twist
Cat. No. 800T-FXTP16RA1



Illuminated 2-Position Push-Pull/Twist
Cat. No. 800H-FRXT16RA1

800 T - FX T PH 16 R A1
a b c d e f g h

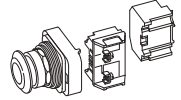

a

Protection Rating	
Code	Description
T	Metal, Type 4/13
H	Plastic, Type 4/4X/13

b

Finger-Safe Guards	
Code	Description
Blank	No guards
C	Guards on terminals

c

Head Type *		
800T Type 4/13	Description	800H Type 4/4X/13
Code		Code
FX	Mushroom head	FRX
FXJ	Jumbo mushroom	FRXJ
FXJE	Jumbo mushroom (push-pull) with "E-Stop"	—

d

Operator Function	
Code	Description
Blank	Push-pull #
T	Push-pull/twist

e

Illumination Options	
Transformer	
Code	Description
P	Incandescent
PH	LED
Full Voltage	
Q	Incandescent
QH	Universal LED
Dual Input	
D	Diode type ▲
DT	Transformer — relay type
DTH	Transformer — relay type LED

f

Voltage §	
Transformer	
Code	Description
16	120V AC 50/60 Hz
26	240V AC 50/60 Hz
Full Voltage	
24	24V AC/DC
10	120V AC/DC
20	240V AC/DC
Universal LED	
2	12...130V AC/DC
Dual Input	
16	120V AC
24	24V AC/DC (dual input diode only)

g

Color Cap	
Code	Color
X	No cap (not valid with head Type J)
A	Amber
B	Blue
C	Clear
G	Green
R	Red
W	White

h

Target		
Contact		
N.O.	O	X
N.C./N.C.L.B.	X	O
Contact Blocks		
Code	Description	
Blank	No contacts	
Standard		
D1	1 N.O.	
D2	1 N.C.	
D4	1 N.C.L.B.	
A	1 N.O. - 1 N.C.	
A1	1 N.O. - 1 N.C.L.B.	
A5	2 N.C.L.B. ▽	
PenTUFF (Low Voltage)		
D1V	1 N.O.	
D2V	1 N.C.	
D4V	1 N.C.L.B.	
AV	1 N.O. - 1 N.C.	

h (cont'd)

Contact Blocks	
Code	Description
Class 1, Div. 2	
Logic Reed	
D1R	1 N.O.
D2R	1 N.C.
AR	1 N.O. - 1 N.C.
Sealed Switch	
D1P	1 N.O.
D2P	1 N.C.
AP	1 N.O. - 1 N.C.
Stackable Sealed Switch	
D1Y	1 N.O.
D2Y	1 N.C.
AY	1 N.O. - 1 N.C.

- § See page 18 for additional voltage code options.
- * Devices with N.C.L.B. contacts meet EN ISO 13850 and IEC 60947-5-5 standards for emergency stop applications.
- # Push-Pull is available only with Bul. 800T.
- ▲ Diode type dual input provides circuit isolation via opposing diodes. Not recommended for use with solid-state outputs.
- ▽ Two stacked 800T-XD4 contact blocks supplied.

3-Position Push-Pull Devices, Illuminated



Illuminated 3-Position Push-Pull
Cat. No. 800T-FXMP16RA7



Illuminated 3-Position Push-Pull
Cat. No. 800H-FRXMP16A7

800 T - FX M PH 16 R A1
a b c d e f g h

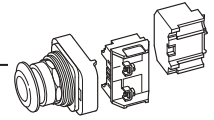

a

Protection Rating	
Code	Description
T	Metal, Type 4/13
H	Plastic, Type 4/4X/13

b

Finger-Safe Guards	
Code	Description
Blank	No guards
C	Guards on terminals

c

Head Type		
800T Type 4/13	Description	800H Type 4/4X/13
Code		Code
FX	Mushroom head	FRX
FXJ	Jumbo mushroom	FRXJ

d

Operator Function			
Code	Operator Position		
	Out	Ctr.	In
M	Mom.	Main.	Main.
N	Mom.	Main.	Mom.

Mom. – Momentary, Main. – Maintained.

e

Illumination Options	
Transformer	
Code	Description
P	Incandescent
PH	LED
Full Voltage	
Q	Incandescent
QH	Universal LED
Dual Input	
D	Diode type [♣]
DT	Transformer — relay type
DTH	Transformer — relay LED

f

Voltage [♣]	
Transformer	
Code	Description
16	120V AC 50/60 Hz
26	240V AC 50/60 Hz
Full Voltage	
24	24V AC/DC
10	120V AC/DC
20	240V AC/DC
Universal LED	
2	12...130V AC/DC
Dual Input	
16	120V AC
24	24V AC/DC [#]

g

Color Cap	
Code	Color
X	No cap (not valid with head Type J)
A	Amber
B	Blue
C	Clear
G	Green
R	Red
W	White

h

Target			
Contact			
N.O.	O	O	X
N.C.	X	O	O
N.C.L.B.	X	X	O
Contact Blocks			
Code	Description		
Blank	No contacts on operator		
Standard			
A	1 N.O. - 1 N.C.		
A1	1 N.O. - 1 N.C.L.B.		
A7	1 N.C. - 1 N.C.L.B.		
PenTUFF (Low Voltage)			
AV	1 N.O. - 1 N.C.		
Class 1, Div. 2			
Logic Reed			
AR	1 N.O. - 1 N.C.		
Sealed Switch			
AP	1 N.O. - 1 N.C.		
Stackable Sealed Switch			
AY	1 N.O. - 1 N.C.		

[♣] See page 18 (Table f) for additional voltage code options.
[♠] Diode type dual input provides circuit isolation via opposing diodes. Not recommended for use with solid-state outputs and neon indicators.
[#] Dual input diode only.

Cluster Pilot Light Devices (Bul. 800T Only)★



Color Cap Only With Lamps
Cat. No. 800T-N249



Complete Unit
Cat. No. 800T-PC416

800T — PC 3 16 W R X R
 a b c d e f g h
 Position 1 Position 2 Position 3 Position 4

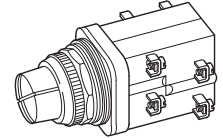

a

Finger-Safe Guards	
Code	Description
Blank	No guards
C	Guards on terminals

b

Power Module Type	
Code	Description
QC	Full voltage
PC	Transformer

c

Illumination Options and No. of Units	
Incandescent	
Code	Description
2	2 unit cluster
3	3 unit cluster
4	4 unit cluster
LED†‡§△	
L2	2 unit cluster
L3	3 unit cluster
L4	4 unit cluster

d

Voltage Options	
Full Voltage	
Code	Description
06	6V AC/DC
12	12V AC/DC
24	24V AC/DC
Transformer	
16	120V AC, 50/60 Hz

e, f, g, h

Color Options	
Code	Color
Blank (All 4 Positions)	Standard unit◆
X	No color
A	Amber
B	Blue
C	Clear
G	Green
R	Red
W	White

Custom Lens Caps for Cluster Pilot Lights

800T — N249 R G A W
 a b c d e f
 Position 1 Position 2 Position 3 Position 4



a

No. of Lamps/Voltage	
Transformer	
Code	Description
N50	4 lamps, 120V AC, 50/60 Hz
N51	3 lamps, 120V AC, 50/60 Hz
N52	2 lamps, 120V AC, 50/60 Hz
N249	4 lamps, 6V AC/DC
N250	4 lamps, 12V AC/DC
N251	4 lamps, 24V AC/DC
N252	3 lamps, 6V AC/DC
N253	3 lamps, 12V AC/DC
N254	3 lamps, 24V AC/DC
N255	2 lamps, 6V AC/DC
N256	2 lamps, 12V AC/DC
N257	2 lamps, 24V AC/DC

b

Illumination Options	
Code	Description
Blank	Incandescent
L	LED†

c, d, e, f

Code	Description
Blank (All Positions)	Standard unit◆
A	Amber
B	Blue
C	Clear
G	Green
R	Red
W	White
X	No color

- ★ Rated Type 4/13 indoor only.
- † LEDs are available in red, green and amber only; lens color matches LED color. Exception: the white lens is supplied with an amber LED.
- § White lenses use amber LEDs.
- ‡ LEDs could be adversely affected when used with solid-state outputs.
- △ 6V and 12V are positive polarity. 24V LEDs are bipolar.
- ◆ Consult your local Rockwell Automation sales office or Allen-Bradley distributor for standard unit colors.

1-, 2-, 3-, 4-Way Toggle Switches (Bul. 800T only)

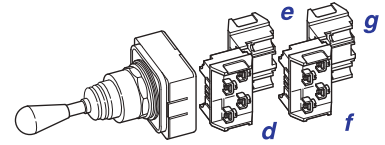
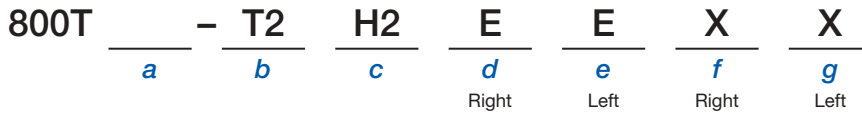

a

Finger-Safe Guards	
Code	Description
Blank	No guards
C	Guards on terminals

b

Operator Type	
Code	Description
T1	1-way toggle
T2	2-way toggle
T3	3-way toggle
T4	4-way toggle

c

Lever Movement and Function						
Type	Function Code	Description				
		↑	←	→	↓	
1-Way	↑ A	1	M	—	—	—
		2	S	—	—	—
	← B	1	—	M	—	—
		2	—	S	—	—
	→ C	1	—	—	M	—
		2	—	—	S	—
	↓ D	1	—	—	—	M
		2	—	—	—	S
2-Way	↕ E	1	M	M	—	—
		2	M	S	—	—
		3	S	S	—	—
		4	S	M	—	—
	↔ F	1	—	M	M	—
		2	—	M	S	—
		3	—	S	S	—
		4	—	S	M	—
2-Way	↙ G	1	—	—	M	M
		2	—	—	M	S
		3	—	—	S	S
		4	—	—	S	M
	↕ H	1	M	—	—	M
		2	M	—	—	S
		3	S	—	—	S
		4	S	—	—	M
↘ J	1	M	—	M	—	
	2	M	—	S	—	
	3	S	—	S	—	
	4	S	—	M	—	
↙ K	1	—	M	—	M	
	2	—	M	—	S	
	3	—	S	—	S	
	4	—	S	—	M	

c (cont'd)

Lever Movement and Function						
Type	Function Code	Description				
		↑	←	→	↓	
3-Way	↕ L	1	M	M	M	—
		2	M	M	S	—
		3	M	S	M	—
		4	M	S	S	—
		5	S	M	M	—
		6	S	S	M	—
		7	S	M	S	—
		8	S	S	S	—
	↕ N	1	—	M	M	M
		2	—	M	M	S
		3	—	M	S	M
		4	—	M	S	S
		5	—	S	M	M
		6	—	S	S	M
		7	—	S	M	S
		8	—	S	S	S
3-Way	↔ P	1	M	—	M	M
		2	M	—	M	S
		3	M	—	S	M
		4	M	—	S	S
		5	S	—	M	M
		6	S	—	S	M
		7	S	—	M	S
		8	S	—	S	S
	↕ Q	1	M	M	—	M
		2	M	M	—	S
		3	M	S	—	M
		4	M	S	—	S
		5	S	M	—	M
		6	S	S	—	M
		7	S	M	—	S
		8	S	S	—	S
4-Way	↕ R	1	M	M	M	M
		2	M	M	M	S
		3	M	M	S	M
		4	M	M	S	S
		5	M	S	M	M
		6	M	S	S	M
		7	M	S	M	S
		8	M	S	S	S
	↕ T	1	S	M	M	M
		2	S	M	M	S
		3	S	M	S	M
		4	S	M	S	S
		5	S	S	M	M
		6	S	S	S	M
		7	S	S	M	S
		8	S	S	S	S

d, e, f, g

Contact Blocks	
Code	Description
Blank (all pos.)	No contacts
Standard	
D	1 N.O.
E	1 N.C.
G	1 N.O.E.M.
J	1 N.C.L.B.
A	1 N.O. - 1 N.C.
X	No contacts in this position
PenTUFF (Low Voltage)	
H	1 N.O.
U	1 N.C.
I	1 N.O.E.M.
Q	1 N.C.L.B.
F	1 N.O. - 1 N.C.
Class 1, Div. 2	
Logic Reed	
V	1 N.O.
W	1 N.C.
T	1 N.O. - 1 N.C.
Sealed Switch	
R	1 N.O.
S	1 N.C.
P	1 N.O. - 1 N.C.
Stackable Sealed Switch	
5	1 N.O.
6	1 N.C.
7	1 N.O. - 1 N.C.

Table 1. Contact Block Code

Contact Block Substitution	
Combination	Code
Standard	
D + E	A
D + D	* M
E + E	N
J + D	B
J + E	C

Table 2. 1-2-3-4 Way Toggle Switch Cam Targets

Contact Configuration					Suffix Code	
Position					Contact/Side	
Up	Left	Center	Right	Down	Right Side	Left Side
O	X	O	O	O	D, H, V, R, 5	—
O	O	O	O	X	E, U, W, S, 6	—
X	O	X	X	X	J, Q	—
X	X	X	X	O	G, I	—
X	O	O	O	O	—	E, U, W, S, 6
O	O	O	X	O	—	D, H, V, R, 5
O	X	X	X	X	—	G, I
X	X	X	O	X	—	J, Q

Note: M = Maintained, S = Spring Return
 * **XA2** and **XA2R** contact blocks cannot be stacked upon, but they can stack on other contact blocks.

Momentary Contact Flip Lever Devices (Bul. 800H Type 4/4X only)



Flip Lever Operator
Cat. No. 800H-WK42B



Flip Lever Operator
Cat. No. 800H-WK61B

800H - WK A
 a b c d

a

Finger-Safe Guards	
Code	Description
Blank	No guards
C	Guards on terminals

b

Operator Color	
Code	Description
4	Grey
6	Red

c

Operator Types			
Code	Description	Code	Description
—	Blank	20	OUT
1	STOP	21	RAISE
2	START	22	RESET
3	CLOSE	23	REVERSE
4	DOWN	24	RIGHT
5	EMERG. STOP	25	RUN
6	FAST	26	SECOND SPEED
7	FORWARD	27	SLOW
8	FULL SPEED	28	TEST
9	HIGH	29	THIRD SPEED
10	IN	30	UP
11	INCH	31	O
12	JOG	32	I
13	LEFT	33	AVANT
14	LOW	34	OUVRIER
15	LOW SPEED	35	ARRIER
16	LOWER	36	MARCHE
17	OFF	37	ESSAI
18	ON	38	ARRET
19	OPEN		

d

Contact Block(s)	
Code	Description
Blank	No contacts
Standard	
D1	1 N.O.
D2	1 N.C.
D3	1 N.O.E.M.
D4	1 N.C.L.B.
D5	1 N.O. (Mini)
D6	1 N.C. (Mini)
A1	1 N.C.L.B. - 1 N.O.
A2	2 N.O.
A4	2 N.C.
A7	1 N.C.L.B. - 1 N.C.
A	1 N.O. - 1 N.C.
B	2 N.O. - 2 N.C.
Class 1, Div. 2	
Sealed Switch	
D1P	1 N.O.
D2P	1 N.C.
AP	1 N.O. - 1 N.C.
BP	2 N.O. - 2 N.C.
Stackable Sealed Switch	
D1Y	1 N.O.
D2Y	1 N.C.
A2Y	2 N.O.
A4Y	2 N.C.
AY	1 N.O. - 1 N.C.
BY	2 N.O. - 2 N.C.

d (cont'd)

Contact Block(s)	
Code	Description
PenTUFF (Low Voltage)	
D1V	1 N.O.
D2V	1 N.C.
D3V	1 N.O.E.M.
D4V	1 N.C.L.B.
AV	1 N.O. - 1 N.C.
BV	2 N.O. - 2 N.C.
Class 1, Div. 2	
Logic Reed	
D1R	1 N.O.
D2R	1 N.C.
A2R	2 N.O. §
A4R	2 N.C.
AR	1 N.O. - 1 N.C.
BR	2 N.O. - 2 N.C.

Protective Boot Application Information**– Chlorosulfonated Polyethylene (synthetic rubber)**

Very resistant to attack by oxidizing chemicals such as concentrated sulfuric acid and hypochlorite solutions. Also resistant to attack by oils and performs well in a wide range of other chemicals and solvents. Good flex and high impact resistance. This is the standard boot material supplied with 800H NEMA Type 4/4X push buttons unless otherwise specified.

– Silicone

Superior high temperature resistance. Particularly suited for use where organic acids or vegetable oils may be present. Also superior resistance to the effects of outdoor use, such as oxygen, ozone, and weather.

– Urethane

Excellent resistance to mechanical failure. Most durable boot material. Particularly suited for use where lubricating oils and automotive fuels may be present. Also well-suited for outdoor use.

– Ethylene-propylene

Particularly suited for high temperature applications. Resistant to attack by many acids and alkalis, detergents, phosphate esters, ketones, alcohols, and glycols. Outstanding service in areas with hot water and steam wash downs.

Approximate Dimensions

Dimensions in inches (millimeters). Dimensions are not intended to be used for manufacturing purposes.

Mounting Instructions for Push Buttons with Shallow Blocks, Mini Blocks, Logic Reed Blocks, Sealed Switch Blocks, and Time Delay Blocks (see footnotes for exceptions)

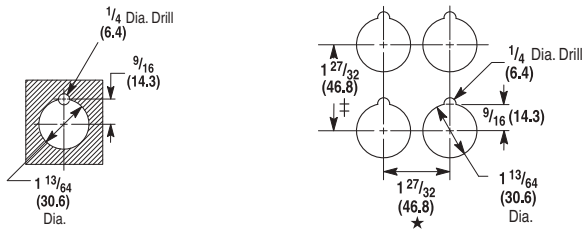

- ★ Change to 2-1/4 in. (57.2 mm) for transformer type pilot light, push-to-test pilot lights, illuminated selector switches, and all push-pull buttons.
Note: Large legend plate requires minimum horizontal spacing of 2-15/32 in. (62.7 mm).
- ‡ Vertical minimum spacing dimension changes for the following legend plates: jumbo 2-15/32 in. (62.7 mm); large 2-7/16 in. (61.9 mm); cluster pilot light and 2-, 3-, 4-way switches 2-1/16 in. (52.4 mm).

Sketch illustrates the minimum distance between centerlines when mounting Bulletin 800T/H controls either side-by-side, facing each other, or one above the other. When control units are mounted so that the contact block terminals face each other, the 2-1/4 in. (57.2 mm) dimension must be used in order to get proper electrical clearance. When control units are mounted so that the contact block terminals do not face each other, the 1-27/32 in. (46.8 mm) dimension can be used.

Typical Panel Cut-Out

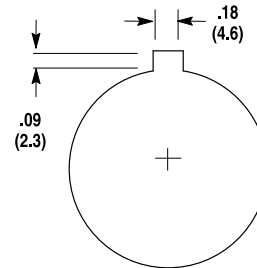

Panel Thickness — Kits are shipped with three 1/16 in. (1.58 mm) gaskets. Refer to table below for number of washers required for various panel thicknesses.

	1/16 in. (1.6 mm) (16 Gauge)	7/64 in. (2.8 mm) (12 Gauge) 9/64 in. (3.6 mm) (10 Gauge)	3/16 in. (4.8 mm) Panel	Thicker Than 3/16 in. (4.8 mm) Panel	Thicker Than 1/4 in. (6.4 mm) Panel
800T	3 washers	2 washers	1 washer	Counterbore to 3/16 in. (4.8 mm)	Counterbore to 3/16 in. (4.8 mm)
800H	4 washers	3 washers	2 washers	1 washer	Counterbore to 1/4 in. (6.4 mm)

Mounting Instructions for 18 mm Small Pilot Lights

Type A Legend Plate

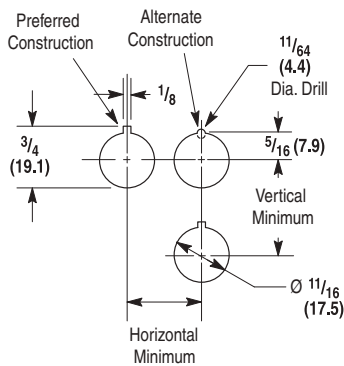

Cat. No. 800T-N515

Type B Legend Plate

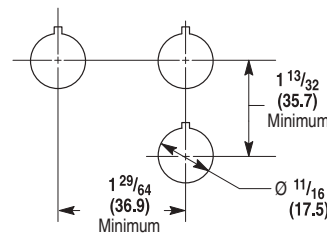

Device	Dimensions	
	Horizontal	Vertical
800T-PS, PSD, PST, QS, QST and RST	31/32 (24.6)	1-5/32 (29.4)
800T-PSDT	1-3/64 (26.6)	1-15/64 (31.4)

Dimensions in inches (millimeters). Dimensions are not intended to be used for manufacturing purposes.

Legend Plate Dimensions (Bul. 800T Only)

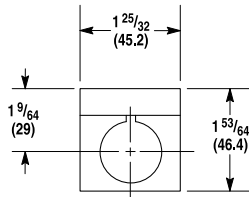

Standard Legend Plate

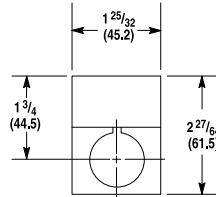

Jumbo Legend Plate

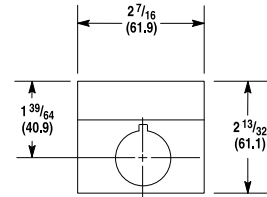

**Large Legend Plate
(Automotive Industry Type)**

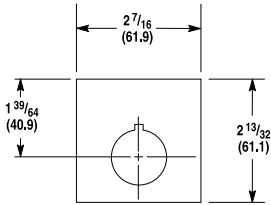

**Large Size
Push-Pull/Twist Legend Plate
Cat. No. 800T-X647 ★**

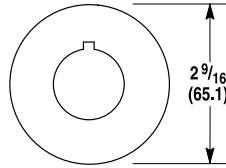

**Round
Cat. No. 800T-X646 ★**

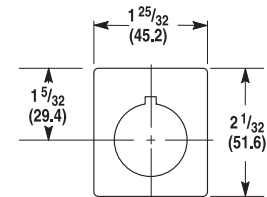

**Cluster Pilot Light and
2-3-4 Way Switch
Silver Legend Plate
Cat. No. 800T-X619**

★ For panel mounting only. Not for use with Allen-Bradley enclosures.

Legend Plate Dimensions (Bul. 800H Only)

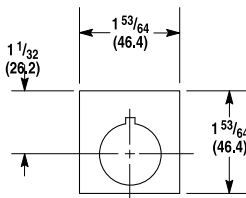

**Type 4/4X
Standard Legend Plate**

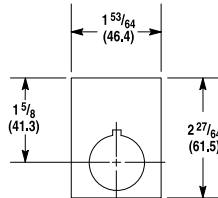

**Type 4/4X
Jumbo Legend Plate**

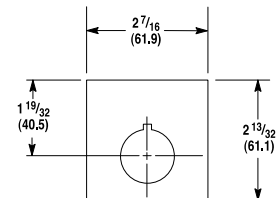

**Type 4/4X
Large Legend Plate
(Automotive Industry Type)**

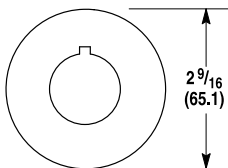

**Type 4/4X
Round**

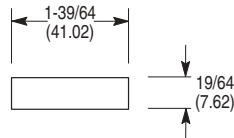

**Type 4/4X
Standard Legend Plate
(Flip Lever Operators)**

Dimensions in inches (millimeters). Dimensions are not intended to be used for manufacturing purposes.

Blocks (Bul. 800T Only)

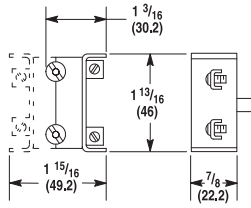

Mini Contact Block
7/8 (22.2) Deep

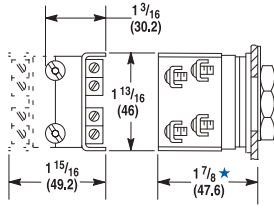

**Shallow, PenTUFF,
and Logic Reed Contact Blocks**
1-1/8 (28.6) Deep

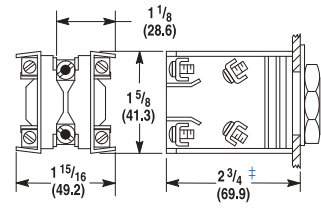

Sealed Switch Block
2 (50.8) Deep

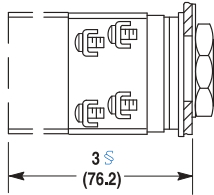

Tandem Mounting
(2 shallow contact
blocks stacked)

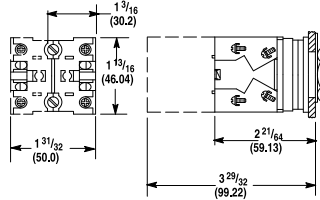

Stackable Sealed Switch Block
1.58 (40.1) Deep

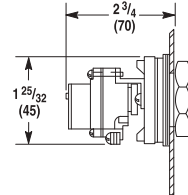

Time Delay Contact Block
(For Push Buttons Only)

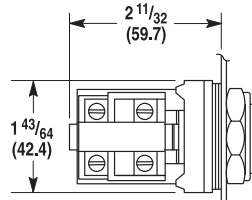
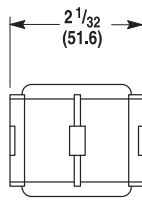

Snap Action Contact Block (For Push Button Only)

★ Dimension shown is for push buttons. Selector switch dimension is 2-1/32 in. (51.6 mm).
 ‡ Dimension shown is for push buttons. Selector switch dimension is 2-27/32 in. (72.2 mm).
 § Dimension shown is for push buttons. Selector switch dimension is 3-5/32 in. (80.2 mm).

Blocks (Bul. 800H Only)

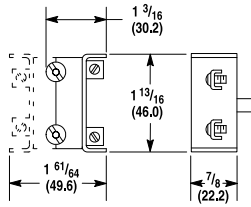

Mini Contact Block

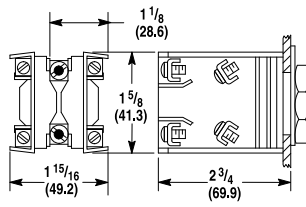

Sealed Switch Block
2 (50.8) Deep

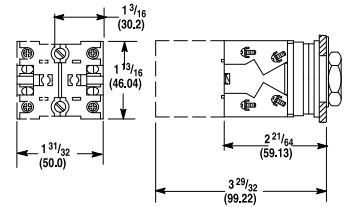

Stackable Sealed Switch Block
1.58 (40.1) Deep

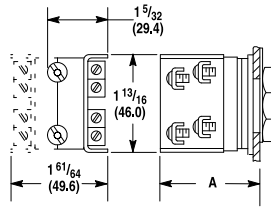

**Shallow, PenTUFF and Logic
Reed Contact Blocks**

Dim.	Momentary Push Button	Maintained Push Button	Selector Switch
A	2 (50.8)	2 (50.8)	1-29/32 (48.4)

Operator Extension Behind Panel — When mounted with thrust washer, trim washer, or notched legend plate and correct number of rubber washers.

Dimensions in inches (millimeters). Dimensions are not intended to be used for manufacturing purposes.

Push Buttons and Switches (Bul. 800T Only)

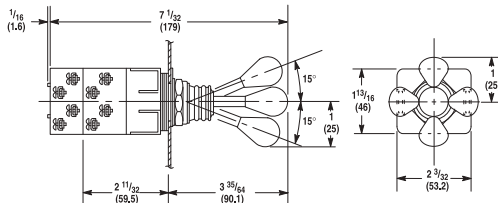

2-3-4 Way Switch
 Shipping Wt. with 2 Contact Blocks 6 oz (0.17 kg)
 Shipping Wt. with 4 Contact Blocks 8-1/2 oz (0.24 kg)

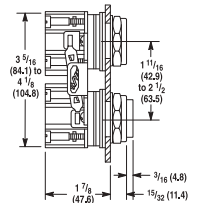

Mechanically Interlocked
 Maintained Contact Push Button
 Shipping Wt. 1 lb (0.45 kg)

Push Buttons and Pilot Lights

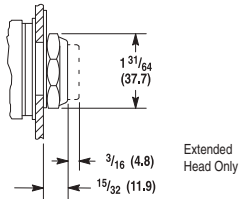

Flush and Extended
 Head Push Button
 Shipping Wt. 5-1/2 oz (0.15 kg)

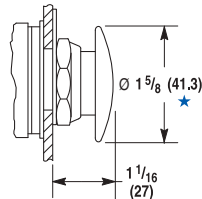

Mushroom Head Push Button
 Shipping Wt. 7-1/2 oz (0.21 kg)

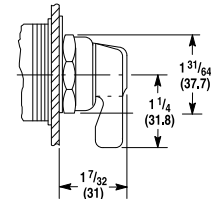

Non-Illuminated Knob Lever and
 Standard Knob Selector Switch
 Shipping Wt. 6 oz (0.17 kg)

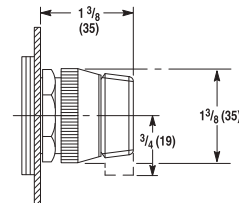

Illuminated Knob Lever and
 Standard Knob Selector Switch
 Shipping Wt. 6 oz (0.17 kg)

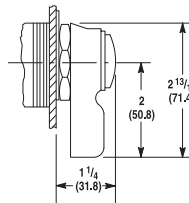

Wing Lever Selector Switch
 Shipping Wt. 8 oz (0.22 kg)

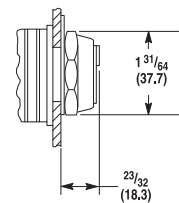

Coin Slot Selector Switch
 Shipping Wt. 6 oz (0.17 kg)

★ Except jumbo which is 2-1/4 (57.2).

Operator Extension in Front of Panel (Bul. 800T Only)

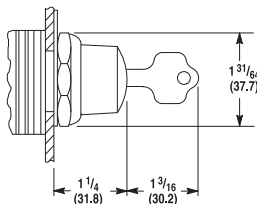

Key Operated Selector Switch
 Shipping Wt. 12 oz (0.34 kg)

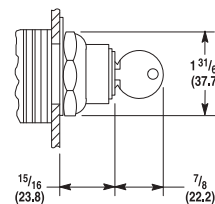

Push Button with Cylinder Lock
 Shipping Wt. 12 oz (0.34 kg)

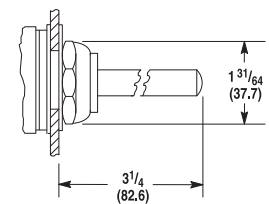

Wobble Stick
 Shipping Wt. 9 oz (0.25 kg)

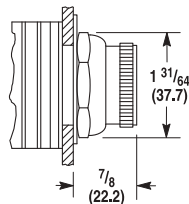

Selector Push Button
 Shipping Wt. 6 oz (0.17 kg)

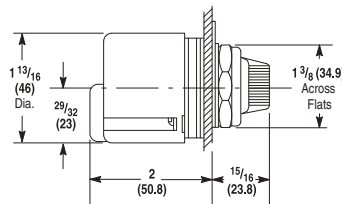

Type J Potentiometer Unit
 Shipping Wt. 4 oz (0.11 kg)

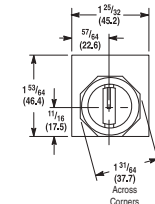

Dimensions in inches (millimeters). Dimensions are not intended to be used for manufacturing purposes.

Push Buttons and Switches (Bul. 800H Only)

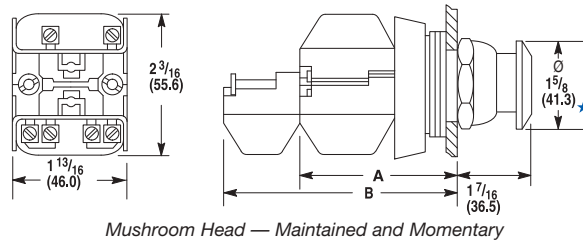
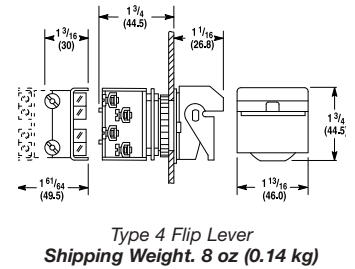
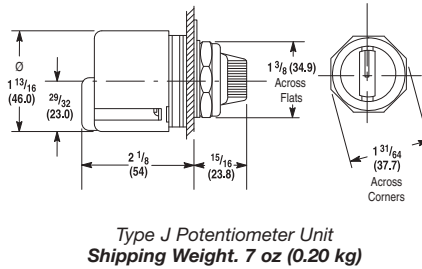
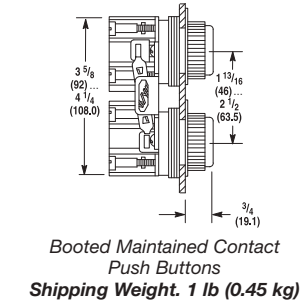
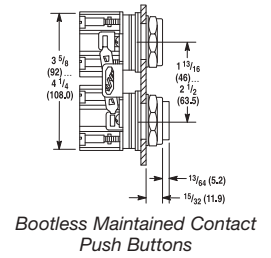
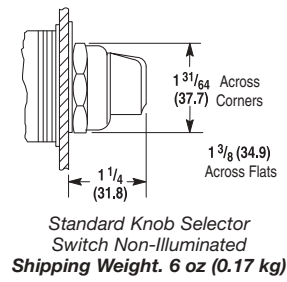
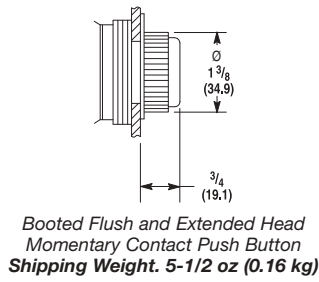
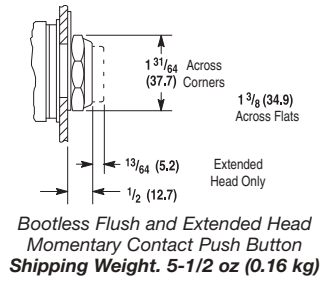

Non-Illuminated Mushroom and Push-Pull Push Buttons				
Cat. No. Suffix	Description	Dimensions		Shipping Weights
D4	One Shallow Block	A	2-1/32 (51.6)	5 oz (0.14 kg)
A1, A5 and A7	Two Shallow blocks	A	2-1/32 (51.6)	6 oz (0.17 kg)
B6	Two Shallow Blocks and Two Mini Blocks	B	2-7/8 (73.0)	8 oz (0.22 kg)

★ Jumbo versions are 2-1/4 (57.2).

Break-Glass Station

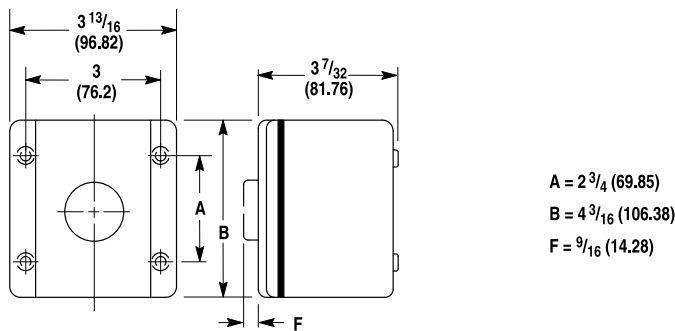

Dimensions in inches (millimeters). Dimensions are not intended to be used for manufacturing purposes.

Pilot Light and Illuminated Devices (Bul. 800T Only)

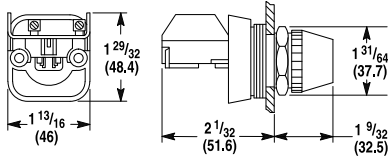

Full Voltage, Neon and Dual Input Pilot Light
Shipping Wt. 5 oz (0.14 kg)

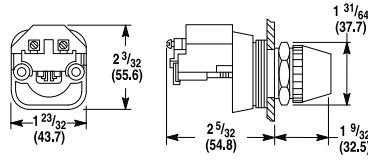

Transformer Type Pilot Light
Shipping Wt. 8 oz (0.22 kg)

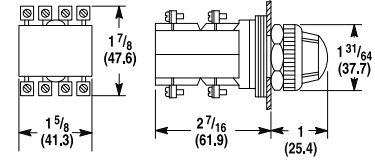

Cluster Pilot Light
Shipping Wt. 12 oz (0.34 kg)

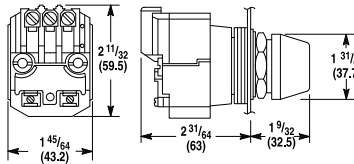

Dual Input Transformer Type Pilot Light

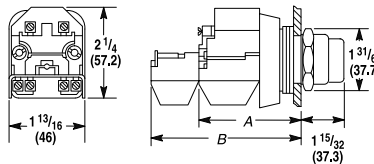

Transformer Type (Push-to-Test Pilot Light and Illuminated Push Button)

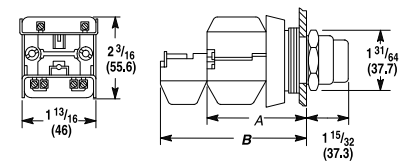

Full Voltage, Neon and Dual Input Type (Push-to-Test Pilot Light and Illuminated Push Button)

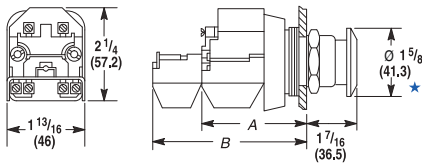

Push-Pull and Twist or Pull Release Units (Transformer Type Illuminated)

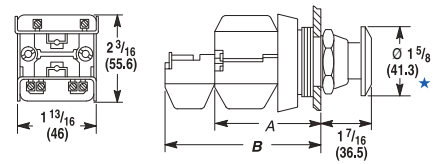

Push-Pull and Twist or Pull Release Units (Full Voltage, Neon and Dual Input Illuminated and All Non-Illuminated)

★ Jumbo mushroom versions are 2-1/4 in. (57.2 mm) diameter.

Push-to-Test Pilot Lights Illuminated Push Buttons and Illuminated Push-Pull Buttons							Non-Illuminated Push-Pull Buttons					
Cat. No. Suffix†	Description	Transformer Type		Full Voltage or Neon Type		Cat. No. Suffix	Description	Transformer Type				
		Dim.	Ship. Wt.	Dim.	Ship. Wt.			Dim.	Ship. Wt.			
D4	Transformer or Terminal Module and One Shallow Contact Block	A	2-5/32 (54.8)§	9 oz. (0.25 kg)	A	2-1/32 (51.6)	7 oz. (0.25 kg)	D4	One Shallow Contact Block	A	2-1/32 (51.6)	5 oz. (0.14 kg)
A1 and A7	Transformer or Terminal Module and One Shallow Block and One Mini Contact Block	B	2-7/8 (73)	10 oz. (0.28 kg)	B	2-7/8 (73)	8 oz. (0.22 kg)	A4 A5 A7	Two Shallow Contact Blocks	A	2-1/32 (51.6)	6 oz. (0.17 kg)
AP D1P D2P	Transformer or Terminal Module and One Sealed Switch Contact Block	A	3-1/32 (77)	10 oz. (0.28 kg)	A	2-29/32 (73.8)	8 oz. (0.22 kg)	B6	Two Shallow Blocks and Two Mini Contact Blocks	B	2-7/8 (73)	8 oz. (0.22 kg)

† Applies to illuminated push-pull push buttons only.

§ Dual input type pilot light dimension is 2-13/32 in. (61.1 mm).

Dimensions in inches (millimeters). Dimensions are not intended to be used for manufacturing purposes.

Push-to-Test Pilot Light and Illuminated Devices (Bul. 800H Only)

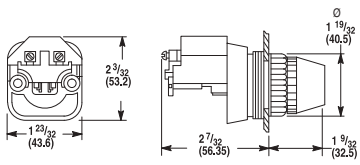

Transformer Type Pilot Light (Incandescent and LED)
Shipping Weight. 12 oz (0.34 kg)

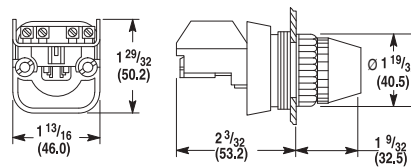

Full Voltage and Dual Input Diode Type Pilot Light (Incandescent, Neon, LED)
Shipping Weight. 5 oz (0.14 kg)

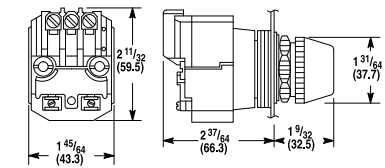

Dual Input Transformer Type Pilot Light
Shipping Weight. 14 oz (0.40 kg)

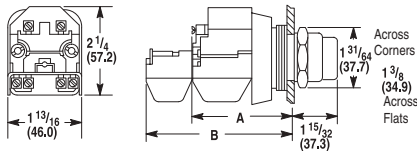

Push-to-Test Pilot Light and Illuminated Push Button (Transformer Type: Incandescent, LED)

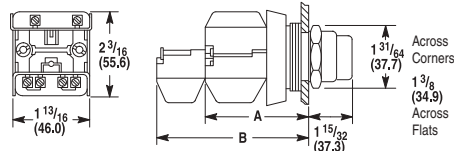

Push-to-Test Pilot Light and Illuminated Push Button (Full Voltage: Incandescent, LED, Neon; and Dual Input Type)

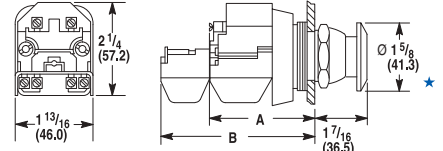

Momentary Mushroom, Push-Pull and Twist or Pull Release Units (Transformer Type: Incandescent, LED; Illuminated)

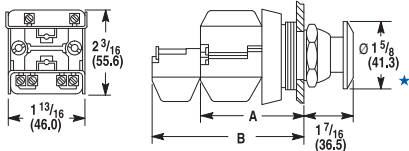

Momentary Mushroom, Push-Pull and Twist or Pull Release Units (Full Voltage: Incandescent, LED, Neon; and Dual Input Illuminated)

Push-to-Test Pilot Lights
Illuminated Push Buttons, Illuminated Push-Pull and Twist or Pull Release Push Buttons

Cat. No. Suffix†	Description	Transformer Type			Full Voltage or Neon Type		
		Dimension	Shipping Weight	Dimension	Shipping Weight		
D4	Transformer or Terminal Module and One Shallow Contact Block	A	2-5/32 (54.8)§	9 oz. (0.25 kg)	A	2-1/32 (51.6)♣	7 oz. (0.20kg)
A1 and A7	Transformer or Terminal Module, One Shallow Block and One Mini Contact Block	B	2-7/8 (73)	10 oz. (0.28 kg)	B	2-7/8 (73)	8 oz. (0.22 kg)
AP	Transformer or Terminal Module and One Sealed Switch Contact Block	B	2-29/32 (73.8)	10 oz. (0.28 kg)	B	2-29/32 (73.8)	8 oz. (0.22 kg)

- ★ Jumbo mushroom versions are 2-1/4 in. (57.2 mm) diameter.
- † Applies to illuminated push-pull push buttons only.
- § Dual input type pilot light dimension is 2-13/32 in. (61.1 mm).
- ♣ Dual input type pilot light dimension is 2-9/32 in. (57.9 mm).

Dimensions in inches (millimeters). Dimensions are not intended to be used for manufacturing purposes.

Accessories

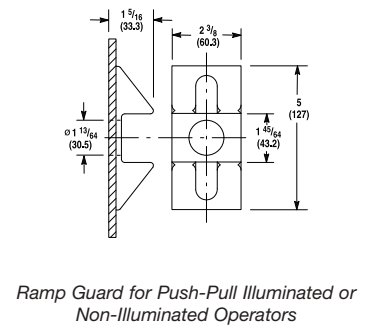
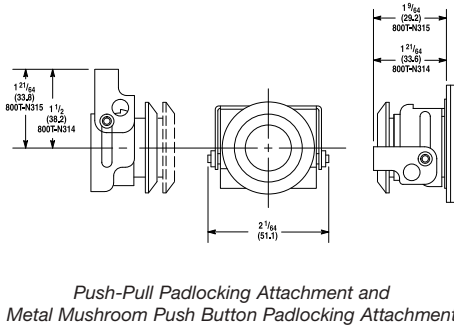
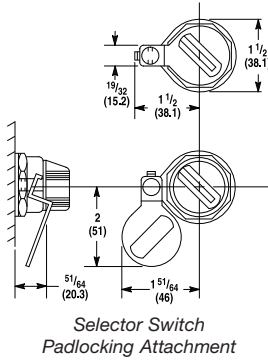
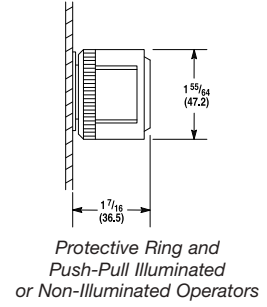
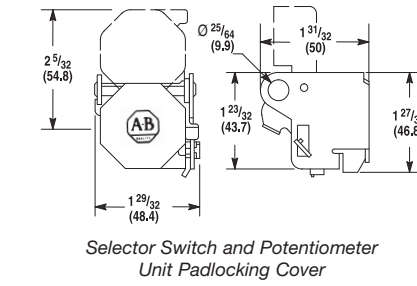
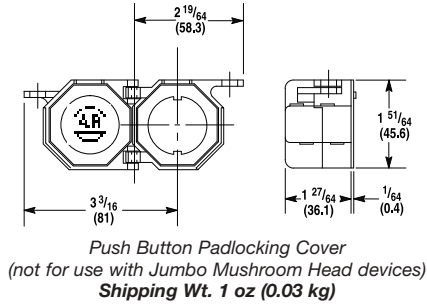

Accessories (Bul. 800H Only)

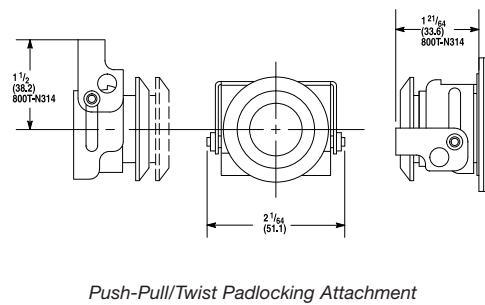
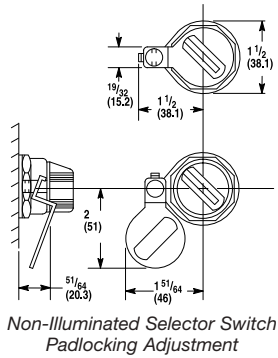
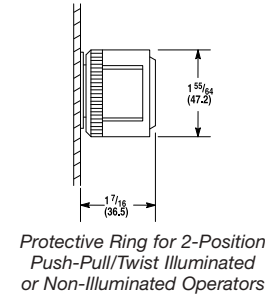
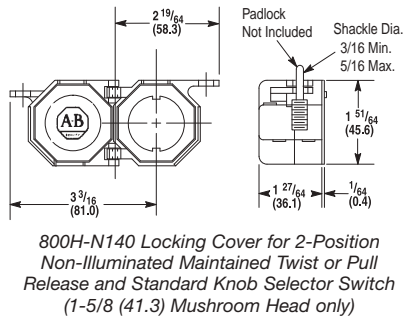
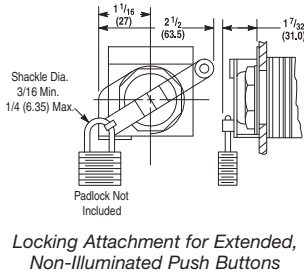

Dimensions in inches (millimeters). Dimensions are not intended to be used for manufacturing purposes.

Die Cast Enclosures (Bul. 800T Only)

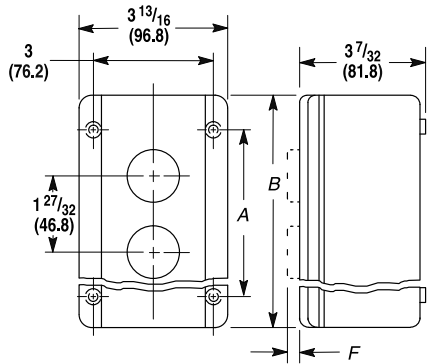

Enclosure Dimensions

Dim.	No. of Units				
	1	2	3	4	6
A	2-3/4 (69.9)	4-1/2 (114.3)	6-1/4 (158.8)	8 (203.2)	12-1/8 (308)
B	4-3/16 (106.4)	5-7/8 (144.2)	7-9/16 (192.1)	9-1/2 (241.3)	13-1/2 (342.4)

Note: Mounting holes (4) — Screw shaft 13/64 in. (5.16 mm) max. diameter.

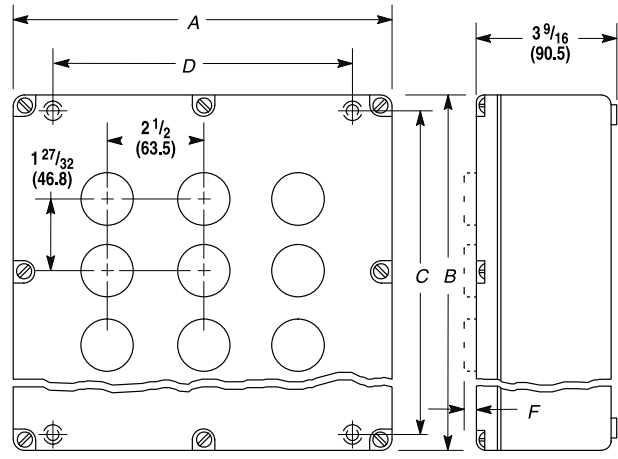

Enclosure Dimensions

Dim.	No. of Units			
	6	9	12	16
A	7-1/4 (184.2)	9-3/4 (247.7)	9-3/4 (247.7)	12-1/2 (317.5)
B	9 (228.6)	9 (228.6)	11 (279.4)	11 (279.4)
C	8-1/4 (209.6)	8-1/4 (209.6)	10-1/8 (257.2)	10-1/8 (257.2)
D	5-3/8 (136.5)	7-7/8 (200)	7-7/8 (200)	10-5/8 (269.9)

Note: Mounting holes (4) — Screw shaft 7/32 in. (5.56 mm) max. diameter.

F Dimension

Type of Unit		Dimension F
Push Buttons	Flush Extended	15/32 (11.9)
	Extended	21/32 (16.7)
	Mushroom	1 (25.4)
	Selector	7/8 (22.2)
	Cylinder Lock	1-13/16 (46)
Selector Switches	Standard	1-7/32 (30.9)
	Cylinder Lock	2-7/16 (61.9)
	Coin Slot	3/4 (19.1)
Pilot Light		1-1/8 (28.6)
Potentiometers		1-1/16 (27)

Conduit Openings

General Class	Description	No. of Units★						
		1...4	6	9	12	16	20	25
Surface Mounted Enclosure	Die Cast	3/4 in. 14 N.P.T.	1 in. 11-1/2 N.P.T.	1 in. 11-1/2 N.P.T.	1 in. 11-1/2 N.P.T.	1-1/2 in. 11-1/2 N.P.T.	—	—

★ Number of units that can be mounted in the enclosure.

Dimensions in inches (millimeters). Dimensions are not intended to be used for manufacturing purposes.

Enclosures (Bul. 800T Only), Continued
Pendant Stations

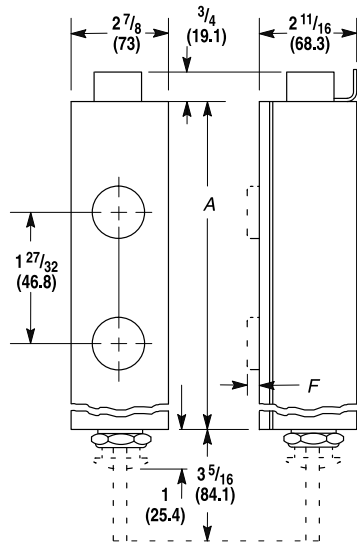

No. of Units	Dimension A
2	5-13/16 (147.6)
3	7-21/32 (194.5)
4	9-1/2 (241.3)
5	11-11/32 (288.1)
6	13-3/16 (335)
7	15-1/32 (381.7)
8	16-7/8 (428.6)
9	18-23/32 (475.4)
10	20-9/16 (522.3)

Sheet Metal Enclosures

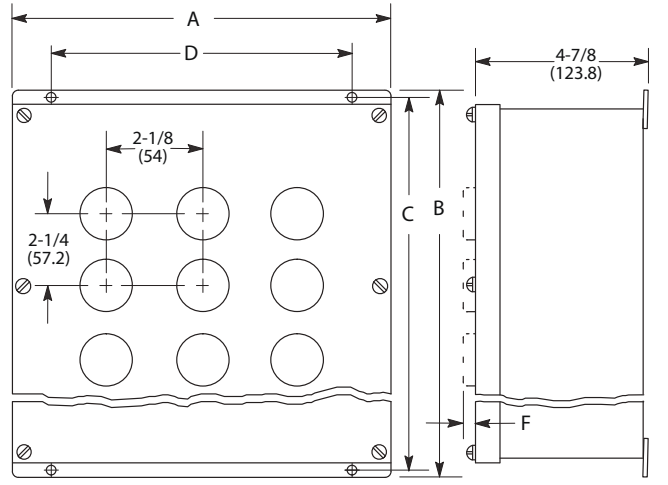

Dim.	Enclosure Dimensions					
	No. of Units					
	6	9	12	16	20	25
A	6-15/16 (176.2)	8-11/16 (220.7)	8-11/16 (220.7)	10-7/16 (265.1)	10-7/16 (265.1)	12-1/2 (317.5)
B	11-1/8 (282.6)	11-1/8 (282.6)	13-1/2 (342.9)	13-1/2 (342.9)	15-7/8 (403.2)	15-7/8 (403.2)
C	10-1/2 (266.7)	10-1/2 (266.7)	12-7/8 (327)	12-7/8 (327)	15-1/4 (387.4)	15-1/4 (387.4)
D	5 (127)	6-3/4 (171.5)	6-3/4 (171.5)	8-1/2 (215.9)	8-1/2 (215.9)	10-1/4 (260.4)

Note: Mounting holes (4) — Screw shaft 7/32 in. (5.56 mm) max. diameter.

F Dimension

Type of Unit		Dimension F
Push Buttons	Flush Extended	15/32 (11.9)
	Extended	21/32 (16.7)
	Mushroom	1 (25.4)
	Selector	7/8 (22.2)
	Cylinder Lock	1-13/16 (46)
Selector Switches	Standard	1-7/32 (30.9)
	Cylinder Lock	2-7/16 (61.9)
	Coin Slot	3/4 (19.1)
Pilot Light		1-1/8 (28.6)
Potentiometers		1-1/16 (27)

Conduit Openings

General Class	Description	No. of Units★					
		1...4	6	9	12	16	20
Surface Mounted Enclosure	Sheet Metal	None — Drilled to suit by customer.					
Pendant Type Enclosure	with Opening in Bottom	2...5			6...10		
		1 (25.4) Conduit Hub			1-1/4 (31.8) Conduit Hub		
	with Opening in Cover	1 (25.4) Conduit Hub			1-1/4 (31.8) Conduit Hub		

★ Number of units that can be mounted in the enclosure.

Dimensions in inches (millimeters). Dimensions are not intended to be used for manufacturing purposes.

Enclosures (Bul. 800H Only)

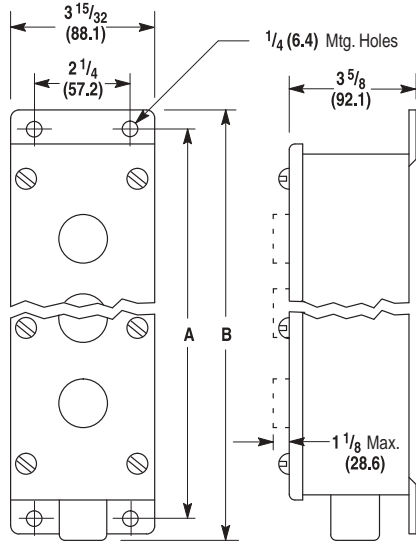

Type 4/4X/13 Stainless Steel

Watertight, Oiltight, Corrosion Resistant Enclosure

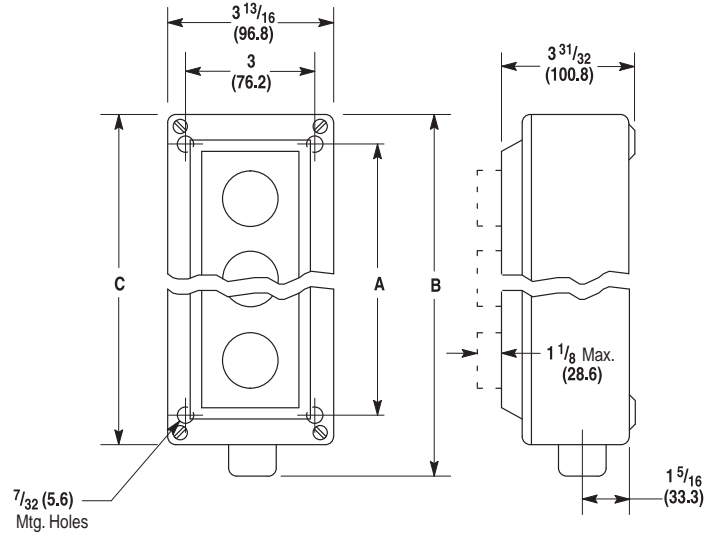

Type 4/4X/13 Rosite Glass Polyester

Watertight, Oiltight, Corrosion Resistant Enclosure

Dimension	Type 4/4X/13 Stainless Steel							
	Number of Units							
	1	2	3	4	5	6	7	8
A	5-5/32 (131)	7 (177.8)	8-27/32 (224.6)	10-11/16 (271.5)	12-17/32 (318.3)	14-3/8 (365.1)	16-7/32 (412)	18-1/16 (458.8)
B	6-13/32 (162.7)	8-1/4 (209.6)	10-1/8 (257.2)	11-31/32 (304)	14-1/32 (356.4)	15-7/8 (403.2)	17-3/4 (450.8)	19-19/32 (497.7)
C	—				—			
Conduit Knockout Size	—				—			
Pipe Tap Size	3/4 (19.1)				1 (25.4)			
Approximate Shipping Wt. [lbs (kg)]	2-3/4 (1.3)	3-3/4 (1.7)	4-3/4 (2.2)	5-3/4 (2.6)	6-3/4 (3.1)	7-3/4 (3.5)	8-3/4 (4)	9-3/4 (4.4)

Dimension	Type 4/4X/13 Rosite					
	Number of Units					
	1	2	3	4	5	6
A	4-1/2 (114.3)	4-1/2 (114.3)	6-1/4 (158.8)	8 (203.2)	12-1/8 (308)	12-1/8 (308)
B	7-1/32 (178.6)	7-1/32 (178.6)	8-23/32 (221.5)	10-21/32 (270.7)	14-7/8 (377.8)	14-7/8 (377.8)
C	5-7/8 (149.2)	5-7/8 (149.2)	7-9/16 (192)	9-1/2 (241.8)	13-1/2 (342.9)	13-1/2 (342.9)
Conduit Knockout Size	—			—		
Pipe Tap Size	3/4 (19.1)			1 (25.4)		
Approximate Shipping Wt. [lbs (kg)]	2 (0.9)	2 (0.9)	2-1/2 (1.1)	3 (1.4)	4 (1.8)	4 (1.8)

Dimensions in inches (millimeters). Dimensions are not intended to be used for manufacturing purposes.

Enclosures (Bul. 800H Only), Continued

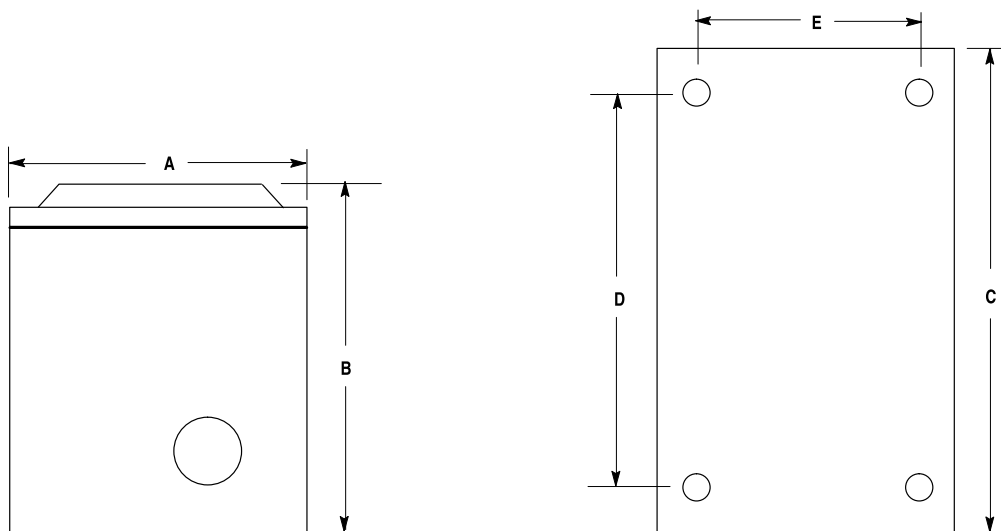

Dimension	Fiberglass Type 4/4X/12/13		
	Number of Units		
	1	2	3
A x B x C	4-1/2 x 5-3/16 x 6 (114.3 x 131.8 x 152.4)	4-1/2 x 5-3/16 x 8 (114.3 x 131.8 x 203.2)	6-1/2 x 5-7/16 x 8 (165.1 x 138.1 x 203.2)
D x E	4-3/4 x 2 (120.7 x 50.8)	6-3/4 x 2 (171.5 x 50.8)	6-3/4 x 4 (171.5 x 101.6)
Conduit Knockout Size	3/4 (19.1)	1 (25.4)	1 (25.4)
Approximate Shipping Wt. [lb (kg)]	2 (0.9)	1/4 (1.0)	3 (1.4)

Typical Pilot Light Wiring Diagrams

See applicable codes and laws

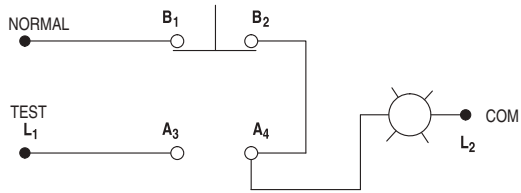

Push-to-Test Pilot Light Device Schematic

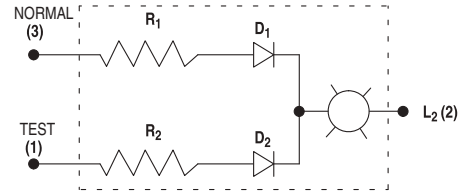

Dual Input Diode Pilot Light Device Schematic

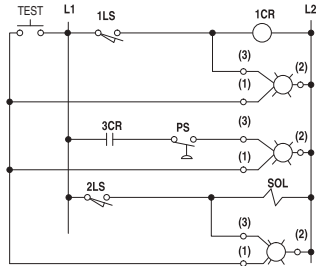

Dual Input Pilot Light Typical Application Wiring Diagram

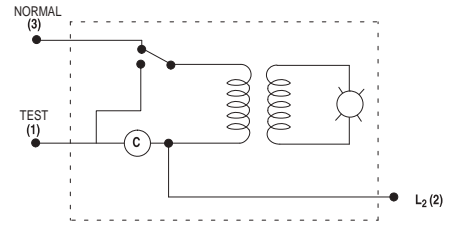

Dual Input Pilot Light Transformer Type Device Schematic

General Purpose Enclosures



Bulletin	800H
Description	Push Button Enclosure
Features	Designed to house 30.5 mm (Bul. 800H) push buttons (available in grey or yellow colors)
Dimensions [mm]	Available in 4 sizes (Height x Width x Depth) 1-Hole: 110 x 80 x 70 2-Hole: 130 x 80 x 85 3-Hole: 180 x 80 x 85 4-Hole: 250 x 80 x 85
Degree of Protection	Type 1, 4, 4X, 12, 13 IP66 Indoor/Outdoor
Storage Temperature Range	-40...+75 °C (-40...+158 °F)
Operating Temperature Range	-40...+55 °C (-40...+131 °F)
Material	
Enclosure	Thermoplastic polyester blend, UL94-5VA
Gasket	Foam-in-place polyetherane
Standards	UL 508A and CSA C22.2, No. 14
Certifications	cULus, CE

Approximate Dimensions

Dimensions are shown in millimeters (inches). Dimensions are not intended to be used for manufacturing purposes.

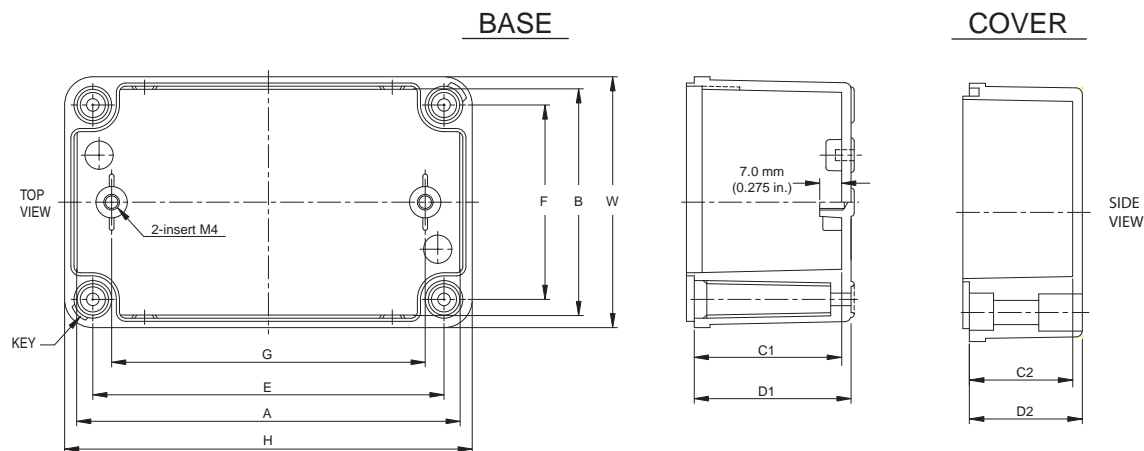

Thermoplastic Polyester Type 4/4X

Cat. No.	Overall Dimension				Inside Dimension				Enclosure Mounting Dimension		Mounting Plate Mounting Dim. G
	H	W	D1	D2	A	B	C1	C2	E	F	
800H-1HZ4	110 (4.33)	80 (3.15)	50 (1.97)	20 (0.79)	104 (4.09)	74 (2.91)	46.5 (1.83)	16.5 (0.65)	92 (3.62)	62 (2.44)	80 (3.15)
800H-2HZ4	130 (5.12)	80 (3.15)	50 (1.97)	35 (1.38)	120 (4.72)	70 (2.76)	46.5 (1.83)	31.5 (1.24)	112 (4.41)	62 (2.44)	100 (3.94)
800H-3HZ4	180 (7.09)	80 (3.15)	50 (1.97)	35 (1.38)	170 (6.69)	70 (2.76)	46.5 (1.83)	31.5 (1.24)	162 (6.38)	62 (2.44)	150 (5.91)
800H-4HZ4	250 (9.84)	80 (3.15)	50 (1.97)	35 (1.38)	240 (9.45)	70 (2.76)	46.5 (1.83)	31.5 (1.24)	232 (9.13)	62 (2.44)	220 (8.66)

Dimensions are shown in millimeters (inches). Dimensions are not intended to be used for manufacturing purposes.

Push Button Hole

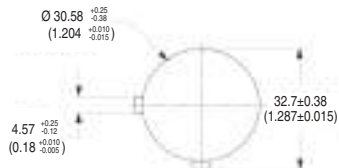

30.5 mm Push Button Hole

Push Button Hole Spacing

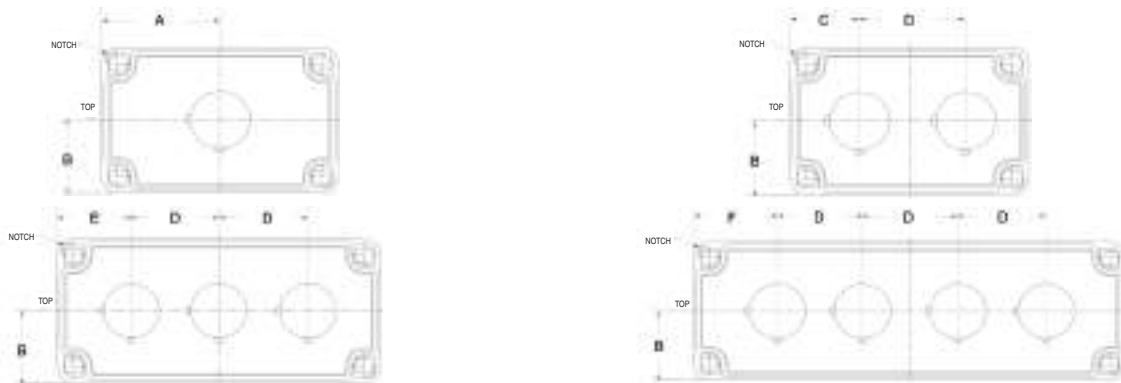

Cat. No.	Type	A	B	C	D	E	F
800H-1HZ4C	1-Hole	55±.216 (2.165±0.0085)	40±0.5 (1.57±0.020)	—	46.8±0.191 (1.843±0.0075)	—	—
800H-2HZ4C	2-Hole	—		41.6±0.175 (1.64±0.0069)		—	—
800H-3HZ4C	3-Hole	—		—		43.2 +0.32/-0.18 (1.7 +0.0126/-0.0071)	—
800H-4HZ4C	4-Hole	—		—		—	54.8±0.216 (2.16±0.0085)

Important User Information

Read this document and the documents listed in the additional resources section about installation, configuration, and operation of this equipment before you install, configure, operate, or maintain this product. Users are required to familiarize themselves with installation and wiring instructions in addition to requirements of all applicable codes, laws, and standards.

Activities including installation, adjustments, putting into service, use, assembly, disassembly, and maintenance are required to be carried out by suitably trained personnel in accordance with applicable code of practice.

If this equipment is used in a manner not specified by the manufacturer, the protection provided by the equipment may be impaired.

In no event will Rockwell Automation, Inc. be responsible or liable for indirect or consequential damages resulting from the use or application of this equipment.

The examples and diagrams in this manual are included solely for illustrative purposes. Because of the many variables and requirements associated with any particular installation, Rockwell Automation, Inc. cannot assume responsibility or liability for actual use based on the examples and diagrams.

No patent liability is assumed by Rockwell Automation, Inc. with respect to use of information, circuits, equipment, or software described in this manual.

Reproduction of the contents of this manual, in whole or in part, without written permission of Rockwell Automation, Inc., is prohibited.

Documentation Feedback

Your comments will help us serve your documentation needs better. If you have any suggestions on how to improve this document, complete this form, publication [RA-DU002](#), available at <http://www.rockwellautomation.com/literature/>.

Allen-Bradley, Rockwell Software, Rockwell Automation, and LISTEN. THINK. SOLVE are trademarks of Rockwell Automation, Inc.
Trademarks not belonging to Rockwell Automation are property of their respective companies.

Rockwell Otomasyon Ticaret A.Ş., Kar Plaza İş Merkezi E Blok Kat:6 34752 İçerenköy, İstanbul, Tel: +90 (216) 5698400

www.rockwellautomation.com

Power, Control and Information Solutions Headquarters

Americas: Rockwell Automation, 1201 South Second Street, Milwaukee, WI 53204-2496 USA, Tel: (1) 414.382.2000, Fax: (1) 414.382.4444
Europe/Middle East/Africa: Rockwell Automation NV, Pegasus Park, De Kleetlaan 12a, 1831 Diegem, Belgium, Tel: (32) 2 663 0600, Fax: (32) 2 663 0640
Asia Pacific: Rockwell Automation, Level 14, Core F, Cyberport 3, 100 Cyberport Road, Hong Kong, Tel: (852) 2887 4788, Fax: (852) 2508 1846

Publication 800-TD009B-EN-P - April 2015

Supersedes Publication 800-TD009A-EN-P - August 2014

Copyright © 2015 Rockwell Automation, Inc. All rights reserved. Printed in the U.S.A.