



# Safety Light Screens

## **EZ-SCREEN®** ..... **page 20**

- Provides point-of-operation, area, access and perimeter safeguarding.
- Protects personnel from injury and equipment from damage.
- Offered with 14 and 30 mm resolution, single-beam points, or multi-beam grids.
- Requires no controller.
- Rated Type 4.
- Available with optional ESD-safe housing, pigtail connectors and cascading on some models.
- Reduced resolution and fixed blanking on EZ-SCREEN Type 4.



## **PICO-GUARD™** ..... **page 36**

- Provides access and short-range perimeter guarding.
- Offers low-cost alternative to cumbersome machine guarding methods.
- Combines fiber optic and photoelectric technologies.
- Uses fiber optic technology for intrinsically safe guarding in explosive or harsh environments.
- Installs easily using inexpensive plastic fiber optics.



## **MICRO-SCREEN®** ..... **page 42**

- Designed for light- to medium-duty production machinery.
- Features ultra-compact emitters and receivers ranging from 102 to 1829 mm long, depending on series and model.
- Offered with optional ESD-safe housing.
- Includes floating blanking and optional fixed blanking.
- Controllers offered with DeviceNet™, E-stop input and muting.



## **MINI-SCREEN®** ..... **page 58**







- Suitable for heavy-duty machine guarding applications—extra robust housing available.
- Features rugged, compact emitters and receivers ranging from 114 to 1829 mm long, depending on series and model.
- Includes floating blanking and selectable auto power-up.
- Offers optional fixed-beam blanking and muting.
- Offered with yellow or black housing on emitters and receivers.



## **EZ-SCREEN® Type 2** . **page 78**

- Designed for lower-risk applications.
- Provides economical, compact optical safeguarding.
- Meets Type 2 requirements per IEC 61496-1/-2.
- Offered with 30 mm resolution and 15 m range.

**SAFETY LIGHT SCREEN SELECTION**

Type	Model		Catalog Page	Safety Category	Resolution	Supply Voltage	Maximum Range
EZ-SCREEN®	Standard Systems		Page 20	4	14 & 30 mm	24V dc	18 m
	Cascade Systems				14 & 30 mm		18 m
	Grid & Point Systems				300 to 584 mm (beam spacing)		70 m
PICO-GUARD™	Grid Systems		Page 36	4	300 to 584 mm (beam spacing)	24V dc	31 m
	Point Systems				—		
MICRO-SCREEN®	Emitters & Receivers		Page 42	4	19 mm	Supplied by controller	9 m
	Standard Series				32 mm		
	V-Series						
	Controllers				N/A	24V dc, 115 or 230V ac	N/A
	Metal Box Controllers						
	DIN Module Controllers					24V dc	
MINI-SCREEN®	Emitters & Receivers		Page 58	4	19 & 25 mm	Supplied by controller	18 m
	Standard Series				38 mm		
	Heavy-Duty Series						
	Controllers				N/A	24V dc, 115V ac or 230V ac	N/A
	Metal Box Controllers						
	DIN Module Controllers					24V dc	
EZ-SCREEN® Type 2	Type 2 Systems		Page 78	2	30 mm	24V dc	15 m

NC = Normally Closed Relay, NO = Normally Open Relay

Safety Output	Blanking	Muting Option	Output Response Time	Housing Material	Environmental Rating
<b>2 PNP OSSD</b> (Trip /Latch Selectable)	Reduced Resolution (floating) 2-beam & Fixed	Optional Accessory (see page 123)	9 to 56 ms	Aluminum housing with yellow polyester powder finish or nickel-plated ESD	IEC IP65
			11 to 56 ms		
	—		≤ 24 ms		
<b>2 PNP OSSD</b> (Trip /Latch Selectable)  <b>See page 108 for controller</b>	—	Optional Accessory (see page 123)	13 ms	Black aluminum housing, tempered glass window	IEC IP65
			See page 108 for controller	<b>12 mm threaded barrel:</b> Black polycarbonate plastic housing <b>30 mm threaded barrel:</b> Stainless steel housing, glass window.	IEC IP67
—	Reduced Resolution (floating) 1- or 2-beam & Fixed	—	< 38 ms (< 48 ms for muting)	Aluminum housing with yellow polyester powder finish or nickel-plated ESD	IEC IP65
				Welded steel box with black polyester powder paint finish	IEC IP64
				Gray polycarbonate	IEC IP20
<b>2 NO</b> (Trip or Latch)	Reduced Resolution (floating) 1- or 2-beam & Fixed	Yes	< 48 to < 72 ms (< 58 to < 82 ms for muting)	Aluminum housing with black anodized or yellow polyester painted finish	IEC IP65
<b>2 or 4 NO</b> (Trip or Latch)		Optional Accessory (see page 123)		Welded steel box with black polyester powder paint finish	IEC IP64
		Optional Accessory (see page 123)		Gray polycarbonate	IEC IP20
<b>2 NO</b> (Trip or Latch)	Reduced Resolution (floating) 1- or 2-beam & Fixed	—	< 48 to < 72 ms (< 58 to < 82 ms for muting)	Aluminum housing with black anodized or yellow polyester painted finish	IEC IP65
		Yes		Welded steel box with black polyester powder paint finish	IEC IP64
		Optional Accessory (see page 123)		Gray polycarbonate	IEC IP20
<b>2 PNP OSSD</b> (Trip or Latch)	—	Optional Accessory (see page 123)	11 to 25 ms	Aluminum housing with yellow polyester powder finish	IEC IP65



# EZ-SCREEN® Safety Light Screens

- Simple, two-piece integrated system has no control box.
- High-resolution 14 and 30 mm EZ-SCREEN® point-of-operation systems provide finger, hand and ankle detection.
- EZ-SCREEN Point and Grid systems allow one-, two-, three- or four-beam perimeter and access guarding.
- Superior optical design and finely focused  $\pm 2.5^\circ$  beam make systems extremely easy to align and maintain.
- Status indicators and diagnostics show when alignment is complete and if there are problems with the installation.
- Redundant microprocessor-controlled, self-checking design exceeds control reliability requirements and is certified per CE (Type 4/Category 4) and cULus (NIPF, UL 61496, UL 1998).
- Unique cascading models (patent-pending) allow up to four systems of any length and resolution to be wired together to form a single safety device.
- Systems have ranges up to 70 m, with power and range for all types of applications including long-range perimeter guarding.

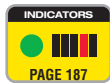

## A complete family of machine guarding products.

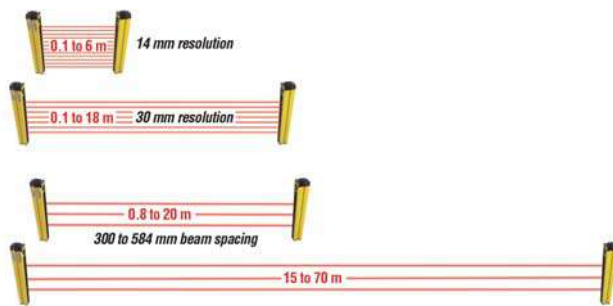

*14 mm Resolution Models . . . . . Page 21*  
*30 mm Resolution Models . . . . . 22*  
*Cascade Systems . . . . . 24*  
*14 and 30 mm Interfacing Products. . . . . 26*  
*14 and 30 mm Resolution Kits . . . . . 27*  
*Grid and Point Models . . . . . 28*  
*Grid and Point Interfacing Products. . . . . 30*  
*Grid Kits . . . . . 31*  
*Point Kits . . . . . 32*

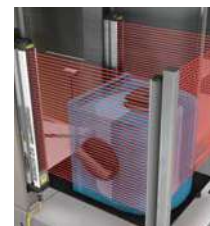
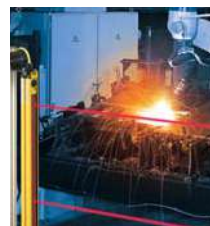
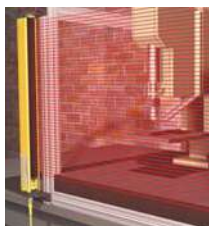

### Point of operation.

- Finger, hand or ankle detection at the point of operation.
- Use 14 or 30 mm EZ-SCREEN.

### Area.

- Mount horizontally to eliminate safety mats and area scanners.
- Manually reset Latch output when area is clear.

### Perimeter.

- Guard multiple sides of a dangerous area up to 70 m long.
- Expand guarding with optional corner mirrors and mounting stands.

### Long-range single sided.

- EZ-SCREEN Grid systems provide 2, 3 or 4 beams.
- Beam spacing is from 300 to 584 mm.

### Single point access.

- Use with angled mirrors to simulate a 2-beam system.
- Use multiple units for custom beam patterns.

### ESD applications.

- Dissipate electrostatic discharges.
- Ideal for microelectronic applications.

**EZ-SCREEN® Systems**

- 7-segment diagnostic display
- Blocked beam zone indicators
- System status and system reset status
- Integral or pigtail Euro-style QD connection
- Durable aluminum housing to resist twisting
- Metal end caps for added durability
- User configurable trip or latch outputs and Scan Code 1 or 2
- Fixed or 2-beam reduced resolution (floating) blanking
- EDM input and optional TEST\*\* function

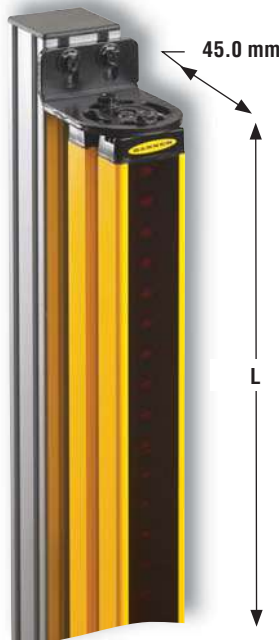

**EZ-SCREEN Systems**



**Full View of Available Finishes**



**Yellow Painted Aluminum**



**Nickel-Plated ESD**

EZ-SCREEN®

PICO-GUARD®

MICRO-SCREEN®

MINI-SCREEN®

EZ-SCREEN®

TYPE 2

**EZ-SCREEN® Systems, 14 mm Resolution**



Models*	Resolution	Range	Defined Area	Housing Length (L)	Supply Voltage	Safety Outputs	Response Time	Connec-tion**	Data Sheet
SLSP14-150Q88† SLSE14-150Q8 SLSR14-150Q8		0.1 to 6 m	150 mm	262 mm	24V dc	<b>2 PNP OSSD</b>	≤ 11 ms	8-pin Euro QD	112852
SLSP14-300Q88† SLSE14-300Q8 SLSR14-300Q8			300 mm	372 mm			≤ 15 ms		
SLSP14-450Q88† SLSE14-450Q8 SLSR14-450Q8			450 mm	522 mm			≤ 19 ms		
SLSP14-600Q88† SLSE14-600Q8 SLSR14-600Q8			600 mm	671 mm			≤ 23 ms		
SLSP14-750Q88† SLSE14-750Q8 SLSR14-750Q8			750 mm	821 mm			≤ 27 ms		
SLSP14-900Q88† SLSE14-900Q8 SLSR14-900Q8			900 mm	971 mm			≤ 32 ms		
SLSP14-1050Q88† SLSE14-1050Q8 SLSR14-1050Q8			1050 mm	1120 mm			≤ 36 ms		

 14 mm Resolution

\* Nickel-plated emitters and receivers used for ESD safe applications are available by adding "N" in the model number (example, **SLSE14-150NQ8**).

\*\* For an emitter with TEST function, replace Q8 with Q5 on emitter model numbers (example, **SLSE14-150Q5**) and Q88 with Q85 on pair model numbers (example, **SLSP14-150Q85**). For a 300 mm Euro pigtail QD, replace "Q" with "P" in models numbers (example, **SLSP14-150P88**). A model with a QD requires a mating cable (see page 176).

† A pair includes an emitter and receiver (example, **SLSP14-150Q88**). Emitters (example, **SLSE14-150Q8**) and receivers (example, **SLSR14-150Q8**) are also sold separately.

# SAFETY LIGHT SCREENS

## EZ-SCREEN® Systems

SAFETY LIGHT SCREENS

EZ-SCREEN®

PICO-GUARD®

MICRO-SCREEN®

MINI-SCREEN®

EZ-SCREEN  
TYPE 2



## EZ-SCREEN® Systems, 14 mm Resolution (cont'd)

Models*	Resolution	Range	Defined Area	Housing Length (L)	Supply Voltage	Safety Outputs	Response Time	Connec-tion**	Data Sheet
SLSP14-1200Q88† SLSE14-1200Q8 SLSR14-1200Q8	 14 mm Resolution	0.1 to 6 m	1200 mm	1270 mm	24V dc	2 PNP OSSD	≤ 40 ms	8-pin Euro QD	112852
SLSP14-1350Q88† SLSE14-1350Q8 SLSR14-1350Q8			1350 mm	1420 mm			≤ 43 ms		
SLSP14-1500Q88† SLSE14-1500Q8 SLSR14-1500Q8			1500 mm	1569 mm			≤ 48 ms		
SLSP14-1650Q88† SLSE14-1650Q8 SLSR14-1650Q8			1650 mm	1719 mm			≤ 52 ms		
SLSP14-1800Q88† SLSE14-1800Q8 SLSR14-1800Q8			1800 mm	1869 mm			≤ 56 ms		

## EZ-SCREEN® Systems, 30 mm Resolution

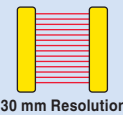

Models*	Resolution	Range	Defined Area	Housing Length (L)	Supply Voltage	Safety Outputs	Response Time	Connec-tion**	Data Sheet
SLSP30-150Q88† SLSE30-150Q8 SLSR30-150Q8	 30 mm Resolution	0.1 to 18 m	150 mm	262 mm	24V dc	2 PNP OSSD	≤ 9 ms	8-pin Euro QD	112852
SLSP30-300Q88† SLSE30-300Q8 SLSR30-300Q8			300 mm	372 mm			≤ 11 ms		
SLSP30-450Q88† SLSE30-450Q8 SLSR30-450Q8			450 mm	522 mm			≤ 13 ms		
SLSP30-600Q88† SLSE30-600Q8 SLSR30-600Q8			600 mm	671 mm			≤ 15 ms		
SLSP30-750Q88† SLSE30-750Q8 SLSR30-750Q8			750 mm	821 mm			≤ 17 ms		



14 mm Resolution



30 mm Resolution

\* Nickel-plated emitters and receivers used for ESD safe applications are available by adding "N" in the model number (example, **SLSE14-1200NQ8**).

\*\* For an emitter with TEST function, replace Q8 with Q5 on emitter model numbers (example, **SLSE14-1200Q5**) and Q88 with Q85 on pair model numbers (example, **SLSP14-1200Q85**). For a 300 mm Euro pigtail QD, replace "Q" with "P" in models numbers (example, **SLSP14-1200P88**). A model with a QD requires a mating cable (see page 176).

† A pair includes an emitter and receiver (example, **SLSP14-1200Q88**). Emitters (example, **SLSE14-1200Q8**) and receivers (example, **SLSR14-1200Q8**) are also sold separately.

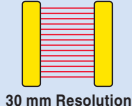

## EZ-SCREEN® Systems, 30 mm Resolution (cont'd)

Models*	Resolution	Range	Defined Area	Housing Length (L)	Supply Voltage	Safety Outputs	Response Time	Connec-tion**	Data Sheet
SLSP30-900Q88† SLSE30-900Q8 SLSR30-900Q8	 30 mm Resolution	0.1 to 18 m	900 mm	971 mm	24V dc	2 PNP OSSD	≤ 19 ms	8-pin Euro QD	112852
SLSP30-1050Q88† SLSE30-1050Q8 SLSR30-1050Q8			1050 mm	1120 mm			≤ 21 ms		
SLSP30-1200Q88† SLSE30-1200Q8 SLSR30-1200Q8			1200 mm	1270 mm			≤ 23 ms		
SLSP30-1350Q88† SLSE30-1350Q8 SLSR30-1350Q8			1350 mm	1420 mm			≤ 25 ms		
SLSP30-1500Q88† SLSE30-1500Q8 SLSR30-1500Q8			1500 mm	1569 mm			≤ 27 ms		
SLSP30-1650Q88† SLSE30-1650Q8 SLSR30-1650Q8			1650 mm	1719 mm			≤ 30 ms		
SLSP30-1800Q88† SLSE30-1800Q8 SLSR30-1800Q8			1800 mm	1869 mm			≤ 32 ms		

 30 mm Resolution

\* Nickel-plated emitters and receivers used for ESD safe applications are available by adding "N" in the model number (example, **SLSE30-900NQ8**).

\*\* For an emitter with TEST function, replace Q8 with Q5 on emitter model numbers (example, **SLSE30-900Q5**) and Q88 with Q85 on pair model numbers (example, **SLSP30-900Q85**). For a 300 mm Euro pigtail QD, replace "Q" with "P" in models numbers (example, **SLSP30-900P88**). A model with a QD requires a mating cable (see page 176).

† A pair includes an emitter and receiver (example, **SLSP30-900Q88**). Emitters (example, **SLSE30-900Q8**) and receivers (example, **SLSR14-900Q8**) are also sold separately.

## EZ-SCREEN® Cascade Systems, 14 mm Resolution

Models*	Resolution	Range	Defined Area	Housing Length (L)	Supply Voltage	Safety Outputs	Response Time**	Conne- ction***	Data Sheet
SLSCP14-300Q88† SLSCE14-300Q8 SLSCR14-300Q8	 14 mm Resolution	0.1 to 6 m	300 mm	372 mm	24V dc	2 PNP OSSD	≤ 15 ms	8-pin Euro QD	112852
SLSCP14-450Q88† SLSCE14-450Q8 SLSCR14-450Q8			450 mm	522 mm			≤ 19 ms		
SLSCP14-600Q88† SLSCE14-600Q8 SLSCR14-600Q8			600 mm	671 mm			≤ 23 ms		
SLSCP14-750Q88† SLSCE14-750Q8 SLSCR14-750Q8			750 mm	821 mm			≤ 27 ms		
SLSCP14-900Q88† SLSCE14-900Q8 SLSCR14-900Q8			900 mm	971 mm			≤ 32 ms		
SLSCP14-1050Q88† SLSCE14-1050Q8 SLSCR14-1050Q8			1050 mm	1120 mm			≤ 36 ms		
SLSCP14-1200Q88† SLSCE14-1200Q8 SLSCR14-1200Q8			1200 mm	1270 mm			≤ 40 ms		
SLSCP14-1350Q88† SLSCE14-1350Q8 SLSCR14-1350Q8			1350 mm	1420 mm			≤ 43 ms		
SLSCP14-1500Q88† SLSCE14-1500Q8 SLSCR14-1500Q8			1500 mm	1569 mm			≤ 48 ms		
SLSCP14-1650Q88† SLSCE14-1650Q8 SLSCR14-1650Q8			1650 mm	1719 mm			≤ 52 ms		
SLSCP14-1800Q88† SLSCE14-1800Q8 SLSCR14-1800Q8	1800 mm	1869 mm	≤ 56 ms						

 14 mm Resolution

\* Nickel-plated emitters and receivers used for ESD safe applications are available by adding "N" in the model number (example, **SLSCE14-300NQ8**).

\*\* **Cascading system response time:** To the response time of the slowest pair, add 2 ms for each additional pair. Example: slowest pair's response time is 15 ms, and the system has three additional pairs (four pairs total), so the system maximum response time is 15 ms + 6 ms (3 pairs x 2 ms) = 21 ms.

\*\*\* For an emitter with TEST function, replace Q8 with Q5 on emitter model numbers (example, **SLSCE14-300Q5**) and Q88 with Q85 on pair model numbers (example, **SLSCP14-300Q85**). For a 300 mm Euro pigtail QD, replace "Q" with "P" in models numbers (example, **SLSCP14-300P88**). A model with a QD requires a mating cable (see page 176).

† A pair includes an emitter and receiver (example, **SLSCP14-300Q88**). Emitters (example, **SLSCE14-300Q8**) and receivers (example, **SLSCR14-300Q8**) are also sold separately.



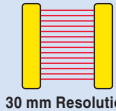

## EZ-SCREEN® Cascade Systems, 30 mm Resolution

Models*	Resolution	Range	Defined Area	Housing Length (L)	Supply Voltage	Safety Outputs	Response Time**	Connection***	Data Sheet
SLSCP30-300Q88† SLSCE30-300Q8 SLSCR30-300Q8	 30 mm Resolution	0.1 to 18 m	300 mm	372 mm	24V dc	2 PNP OSSD	≤ 11 ms	8-pin Euro QD	112852
SLSCP30-450Q88† SLSCE30-450Q8 SLSCR30-450Q8			450 mm	522 mm			≤ 13 ms		
SLSCP30-600Q88† SLSCE30-600Q8 SLSCR30-600Q8			600 mm	671 mm			≤ 15 ms		
SLSCP30-750Q88† SLSCR30-750Q8 SLSCR30-750Q8			750 mm	821 mm			≤ 17 ms		
SLSCP30-900Q88† SLSCE30-900Q8 SLSCR30-900Q8			900 mm	971 mm			≤ 19 ms		
SLSCP30-1050Q88† SLSCE30-1050Q8 SLSCR30-1050Q8			1050 mm	1120 mm			≤ 21 ms		
SLSCP30-1200Q88† SLSCE30-1200Q8 SLSCR30-1200Q8			1200 mm	1270 mm			≤ 23 ms		
SLSCP30-1350Q88† SLSCE30-1350Q8 SLSCR30-1350Q8			1350 mm	1420 mm			≤ 25 ms		
SLSCP30-1500Q88† SLSCE30-1500Q8 SLSCR30-1500Q8			1500 mm	1569 mm			≤ 27 ms		
SLSCP30-1650Q88† SLSCE30-1650Q8 SLSCR30-1650Q8			1650 mm	1719 mm			≤ 30 ms		
SLSCP30-1800Q88† SLSCE30-1800Q8 SLSCR30-1800Q8			1800 mm	1869 mm			≤ 32 ms		



\* Nickel-plated emitters and receivers used for ESD safe applications are available by adding "N" in the model number (example, **SLSCE30-300NQ8**).

\*\* **Cascading system response time:** To the response time of the slowest pair, add 2 ms for each additional pair. Example: slowest pair's response time is 15 ms, and the system has three additional pairs (four pairs total), so the system maximum response time is 15 ms + 6 ms (3 pairs x 2 ms) = 21 ms.

\*\*\* For an emitter with TEST function, replace Q8 with Q5 on emitter model numbers (example, **SLSCE30-300Q5**) and Q88 with Q85 on pair model numbers (example, **SLSCP30-300Q85**). For a 300 mm Euro pigtail QD, replace "Q" with "P" in models numbers (example, **SLSCP30-300P88**). A model with a QD requires a mating cable (see page 176).

† A pair includes an emitter and receiver (example, **SLSCP30-300Q88**). Emitters (example, **SLSCE30-300Q8**) and receivers (example, **SLSCR30-300Q8**) are also sold separately.



# EZ-SCREEN® Interfacing Products

	Models	Description	Product Information	Data Sheet	
<b>Interface Modules</b>	 <b>IM-T-9A</b> (3 NO)	<ul style="list-style-type: none"> <li>Interface modules provide two or three normally open force-guided relay outputs rated at 6 A.</li> <li>EZ-SCREEN monitors these interface modules when they are connected to the EZ-SCREEN External Device Monitoring (EDM) inputs.</li> <li>Convenient plug-in terminal blocks on a 22.5 mm DIN-rail mountable housing are included.</li> </ul>	Page 132	62822	
	<b>IM-T-11A</b> (2 NO/1 NC)				
<b>Muting Modules</b>	 <b>MM-TA-12B</b>	<ul style="list-style-type: none"> <li>The Muting Module temporarily inhibits a safety light screen so materials can safely pass through the screen without stopping the machinery.</li> <li>The module uses redundant microcontroller-based logic.</li> </ul>	Page 123	63517	
	<b>MMD-TA-12B</b>			116390	
	<b>MMD-TA-11B</b>				
<b>Receiver AC Interface Boxes</b>	 <b>EZAC-R9-QE8</b>	<ul style="list-style-type: none"> <li>Versatile power supplies allow EZ-SCREEN systems to connect to AC power sources.</li> <li>Models are available to accommodate receivers only, emitters only, or both.</li> <li>Receiver models include 8 amp safety relay output.</li> </ul>	Page 184	120321	
	<b>EZAC-R11-QE8</b>				
	<b>EZAC-R15A-QE8-QS83</b>				
	<b>EZAC-R8N-QE8-QS53</b>				
	<b>EZAC-R10N-QE8-QS53</b>				
<b>Emitter AC Interface Boxes</b>	 <b>EZAC-E-QE8</b>				
	<b>EZAC-E-QE5</b>				
	<b>EZAC-E-QE8-QS3</b>				
	<b>EZAC-E-QE5-QS5</b>				
<b>Contactors</b>		<b>Mechanically Linked Contactors</b>	<ul style="list-style-type: none"> <li>Pairs of contactors create safety stop circuits with two normally open contacts in series.</li> <li>EZ-SCREEN can monitor the circuit because of the contacts' force-guided mechanically linked design.</li> <li>Contactors add 10 or 16 amp current carrying capability to any safety system.</li> <li>Auxiliary contacts add 3 or 4 normally open contacts.</li> <li>Suppressors extend the life of an actuating device that uses a contactor.</li> <li>Modular design simplifies assembly and installation.</li> </ul>	Page 186	111881
	<b>11-BG00-31-D-024</b>				
	<b>11-BF16C01-024</b>				
	<b>Aux. Contacts</b>				
	<b>11-BGX10-40</b>				
	<b>11-G484-30</b>				
	<b>Suppressors</b>				
	<b>11-BGX77-048</b>				
<b>11-G318-48</b>					

# EZ-SCREEN® 14 & 30 mm Resolution Kits



You can purchase a kit that contains an emitter and receiver of equal length and resolution; brackets; and optional interfacing solution and quick-disconnect cables. Detailed information about individual kit components is as follows.

- Emitter and Receivers . . . . . Page 21
- Interfacing Options . . . . . 26
- Cables . . . . . 176
- Brackets . . . . . 190

A **partial listing** of kits is listed below; see Kit Model Key to order other variations.

Kit Model Number	Sensor Housing		Cascading	Protected Height	Resolution	Range	Supply Voltage	No. of Outputs	Output Options	Emitter & Receiver Connection	Interfacing Options	QD Cabling						
	Yellow	Nickel-Plated																
SLSK14-600Q88-1RE25	•		No	600 mm	14 mm	6 m	24V dc	2 OSSD	Trip/Latch Selectable	Integral Euro QD without Test	IM-T-9A, 1 each	8 m, 2 each						
SLSK30-600Q88-1RE25					30 mm	18 m												
SLSK14-600NQ88-1RE25		•			14 mm	6 m												
SLSK30-600NQ88-1RE25					30 mm	18 m												
SLSCK14-600Q88-1RE25	•		Yes*	600 mm	14 mm	6 m							24V dc	2 OSSD	Trip/Latch Selectable	Integral Euro QD without Test	IM-T-9A, 1 each	8 m, 2 each
SLSCK30-600Q88-1RE25					30 mm	18 m												
SLSCK14-600NQ88-1RE25		•			14 mm	6 m												
SLSCK30-600NQ88-1RE25					30 mm	18 m												

\* For cascading systems, order one kit; up to three additional emitter/receiver pairs; and two double-ended cables per additional emitter/receiver pair. Opposed pairs must be the same length and resolution (see page 24).

## Kit Model Key

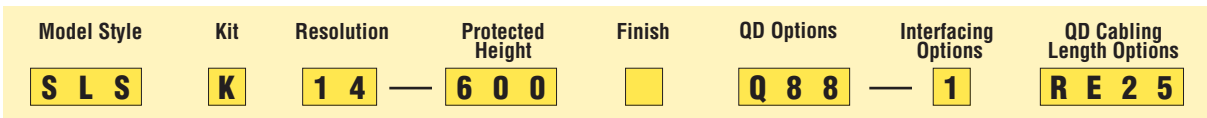

**Model Style**

**SLS** = Safety Light Screen  
**SLSC** = Cascading Safety Light Screen

**Kit**

**K** = Kit

**SLS Resolution**

**14** = 14 mm  
**30** = 30 mm

**Protected Height**

150 mm  
300 mm  
450 mm  
600 mm  
750 mm  
900 mm  
1050 mm  
1200 mm  
1350 mm  
1500 mm  
1650 mm  
1800 mm

**Sensor Finish**

**Blank** = Yellow powder coat  
**N** = Nickel plated ESD

**Receiver & Emitter QD Options**

**Q85** = Receiver with integral 8-pin Euro-style QD  
Emitter with integral 5-pin Euro-style QD with Test

**Q88** = Receiver with integral 8-pin Euro-style QD  
Emitter with integral 8-pin Euro-style QD

**P85** = Receiver with integral 8-pin Euro-style pigtail QD  
Emitter with integral 5-pin Euro-style pigtail QD with Test

**P88** = Receiver with integral 8-pin Euro-style pigtail QD  
Emitter with integral 8-pin Euro-style pigtail QD

**QD Cabling Length Options**

**RE15** = 5 m, 2 each  
**RE25** = 8 m, 2 each  
**R15E25** = 5 m (Receiver) & 8 m (Emitter)  
**R25E15** = 8 m (Receiver) & 5 m (Emitter)  
**RE50** = 15 m, 2 each  
**R15E50** = 5 m (Receiver) & 15 m (Emitter)  
**R50E15** = 15 m (Receiver) & 5 m (Emitter)  
**R25E50** = 8 m (Receiver) & 15 m (Emitter)  
**R50E25** = 15 m (Receiver) & 8 m (Emitter)  
**RE75** = 23 m, 2 each  
**RE100** = 30 m, 2 each

**Interfacing Options**

**1** = IM-T-9A Interface Module, 1 each  
**2** = IM-T-11A Interface Module, 1 each  
**3** = 11-BG00-31-D-Q24 Contactors (10A), 2 each  
**4** = 11-BF16C01-Q24 Contactors (16A), 2 each  
**5** = EZAC-R9-QE8 = AC Interface Box (3 NO), 1 each  
**6** = EZAC-R11-QE8 = AC Interface Box (2 NO/1 NC), 1 each

NOTE: Not all combinations are possible. Contact Banner Engineering Corp. for additional information and/or verification of valid kit model numbers.

# SAFETY LIGHT SCREENS

## EZ-SCREEN® Systems

SAFETY LIGHT SCREENS

### EZ-SCREEN® Grid & Point Systems

- One to four beam models for access or perimeter guarding applications
- Range from 0.8 to 20 m or 15 to 70 m, depending on model
- 7-segment diagnostic display
- Bi-color status indicator
- IEC 61496-1 Type 4
- User configurable trip or latch outputs and Scan Code 1 or 2
- Configuration access port
- Models with integral Mini and Euro QD, or wiring terminal chamber
- QD cables ordered separately (see page 179)



EZ-SCREEN Grid



EZ-SCREEN Point



Detailed Dimensions

Full View





EZ-SCREEN Grid



EZ-SCREEN Point

### EZ-SCREEN® Grid & Point Systems



Models	Beam Spacing	Range	Protected Height	Housing Length (L)	Supply Voltage	Safety Outputs	Response Time	Connection*	Data Sheet
SGP4-300Q83 <sup>†</sup>	 300 mm	0.8 to 20 m	900 mm	1084 mm	24V dc	2 PNP OSSD	≤ 24 ms	Emitter, 3-pin Mini QD Receiver, 8-pin Mini QD	68410
SGE4-300Q3								3-pin Mini QD	
SGR4-300Q8								8-pin Mini QD	
SGXLP4-300Q83 <sup>†</sup>		15 to 70 m						Emitter, 3-pin Mini QD Receiver, 8-pin Mini QD	
SGXLE4-300Q3								3-pin Mini QD	
SGR4-300Q8								8-pin Mini QD	
SGP3-400Q83 <sup>†</sup>	 400 mm	0.8 to 20 m	800 mm	984 mm	24V dc	2 PNP OSSD	≤ 24 ms	Emitter, 3-pin Mini QD Receiver, 8-pin Mini QD	68410
SGE3-400Q3								3-pin Mini QD	
SGR3-400Q8								8-pin Mini QD	
SGXLP3-400Q83 <sup>†</sup>		15 to 70 m						Emitter, 3-pin Mini QD Receiver, 8-pin Mini QD	
SGXLE3-400Q3								3-pin Mini QD	
SGR3-400Q8								8-pin Mini QD	

 4-Beam Grid     3-Beam Grid



\* For emitters and receivers with a wiring terminal chamber, remove the Q3, Q8 or Q83 from the model number (example, **SGE4-300**). For an emitter with TEST function, replace Q3 with Q5 on emitter model numbers (example, **SGE4-300Q5**) and Q83 with Q85 on pair model numbers (example, **SGP4-300Q85**). For emitters and receivers with an 8-pin integral Euro QD, replace Q3 with Q8E on model numbers (example, **SGE4-300Q8E**) and Q83 with Q88E on pair model numbers (example, **SGP4-300Q88E**). A model with a QD requires a mating cable (see page 178).

<sup>†</sup> A pair includes an emitter and receiver (example, **SGP4-300Q83**). Emitters (example, **SGE4-300Q3**) and receivers (example, **SGR4-300Q8**) are also sold separately.



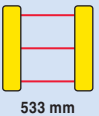
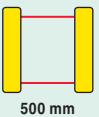
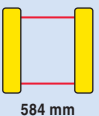

## EZ-SCREEN® Grid &amp; Point Systems (cont'd)

Models	Beam Spacing	Range	Protected Height	Housing Length (L)	Supply Voltage	Safety Outputs	Response Time	Connection*	Data Sheet
SGP3-533Q83 <sup>†</sup>	 533 mm	0.8 to 20 m	1066 mm	1251 mm	24V dc	2 PNP OSSD	≤ 24 ms	Emitter, 3-pin Mini QD Receiver, 8-pin Mini QD	68410
SGE3-533Q3								3-pin Mini QD	
SGR3-533Q8		8-pin Mini QD							
SGXLP3-533Q83 <sup>†</sup>		15 to 70 m						Emitter, 3-pin Mini QD Receiver, 8-pin Mini QD	
SGXLE3-533Q3								3-pin Mini QD	
SGR3-533Q8		8-pin Mini QD							
SGP2-500Q83 <sup>†</sup>	 500 mm	0.8 to 20 m	500 mm	684 mm				Emitter, 3-pin Mini QD Receiver, 8-pin Mini QD	
SGE2-500Q3								3-pin Mini QD	
SGR2-500Q8		8-pin Mini QD							
SGXLP2-500Q83 <sup>†</sup>		15 to 70 m						Emitter, 3-pin Mini QD Receiver, 8-pin Mini QD	
SGXLE2-500Q3								3-pin Mini QD	
SGR2-500Q8		8-pin Mini QD							
SGP2-584Q83 <sup>†</sup>	 584 mm	0.8 to 20 m	584 mm	768 mm	Emitter, 3-pin Mini QD Receiver, 8-pin Mini QD				
SGE2-584Q3					3-pin Mini QD				
SGR2-584Q8		8-pin Mini QD							
SGXLP2-584Q83 <sup>†</sup>		15 to 70 m			Emitter, 3-pin Mini QD Receiver, 8-pin Mini QD				
SGXLE2-584Q3					3-pin Mini QD				
SGR2-584Q8		8-pin Mini QD							
SPP1Q83 <sup>†</sup>	 1-BEAM	0.8 to 20 m	N/A	149 mm	Emitter, 3-pin Mini QD Receiver, 8-pin Mini QD				
SPE1Q3					3-pin Mini QD				
SPR1Q8		8-pin Mini QD							
SPXLP1Q83 <sup>†</sup>		15 to 70 m			Emitter, 3-pin Mini QD Receiver, 8-pin Mini QD				
SPXLE1Q3					3-pin Mini QD				
SPR1Q8		8-pin Mini QD							

 3-Beam Grid  
  2-Beam Grid  
  1-Beam Point

\*\* For emitters and receivers with a wiring terminal chamber, remove the Q3, Q8 or Q83 from the model number (example, **SGE3-533**). For an emitter with TEST function, replace Q3 with Q5 on emitter model numbers (example, **SGE3-533Q5**) and Q83 with Q85 on pair model numbers (example, **SGP3-533Q85**). For emitters and receivers with an 8-pin integral Euro QD, replace Q3 with Q8E on model numbers (example, **SGE3-533Q8E**) and Q83 with Q88E on pair model numbers (example, **SGP3-533Q88E**). A model with a QD requires a mating cable (see page 178).

<sup>†</sup> A pair includes an emitter and receiver (example, **SGP3-533Q83**). Emitters (example, **SGE3-533Q3**) and receivers (example, **SGR3-533Q8**) are also sold separately.



# EZ-SCREEN® Grid & Point Interfacing Products

	Models	Description	Product	Data Sheet
<b>Interface Modules</b>	 <b>IM-T-9A</b> (3 NO)	<ul style="list-style-type: none"> <li>Interface modules provide two or three normally open force-guided relay outputs rated at 6 A.</li> <li>EZ-SCREEN monitors these interface modules when they are connected to the EZ-SCREEN External Device Monitoring (EDM) inputs.</li> <li>Convenient plug-in terminal blocks on a 22.5 mm DIN-rail mountable housing are included.</li> </ul>	Page 132	62822
	<b>IM-T-11A</b> (2 NO/1 NC)			
<b>Muting Modules</b>	 <b>MM-TA-12B</b>	<ul style="list-style-type: none"> <li>The Muting Module temporarily inhibits a safety light screen so materials can safely pass through the screen without stopping the machinery.</li> <li>The module uses redundant microcontroller-based logic.</li> </ul>	Page 123	63517
	<b>MMD-TA-12B</b>			116390
	<b>MMD-TA-11B</b>			
<b>Receiver AC Interface Boxes</b>	 <b>EZAC-R9-QE8</b>	<ul style="list-style-type: none"> <li>Versatile power supplies allow EZ-SCREEN systems to connect to AC power sources.</li> <li>Models are available to accommodate receivers only, emitters only, or both.</li> <li>Receiver models include 8 amp safety relay output.</li> </ul>	Page 184	120321
	<b>EZAC-R11-QE8</b>			
	<b>EZAC-R15A-QE8-QS83</b>			
	<b>EZAC-R8N-QE8-QS53</b>			
	<b>EZAC-R10N-QE8-QS53</b>			
<b>Emitter AC Interface Boxes</b>	 <b>EZAC-E-QE8</b>	<ul style="list-style-type: none"> <li>Versatile power supplies allow EZ-SCREEN systems to connect to AC power sources.</li> <li>Models are available to accommodate receivers only, emitters only, or both.</li> <li>Receiver models include 8 amp safety relay output.</li> </ul>	Page 184	120321
	<b>EZAC-E-QE5</b>			
	<b>EZAC-E-QE8-QS3</b>			
	<b>EZAC-E-QE5-QS5</b>			
<b>Contactors</b>		<b>Mechanically Linked Contactors</b>	Page 186	111881
	<b>11-BG00-31-D-024</b>	<ul style="list-style-type: none"> <li>Pairs of contactors create safety stop circuits with two normally open contacts in series.</li> <li>EZ-SCREEN can monitor the circuit because of the contacts' force-guided mechanically linked design.</li> </ul>		
	<b>11-BF16C01-024</b>			
	<b>Aux. Contacts</b>	<ul style="list-style-type: none"> <li>Contactors add 10 or 16 amp current carrying capability to any safety system.</li> <li>Auxiliary contacts add 3 or 4 normally open contacts.</li> </ul>		
	<b>11-BGX10-40</b>			
	<b>11-G484-30</b>			
	<b>Suppressors</b>	<ul style="list-style-type: none"> <li>Suppressors extend the life of an actuating device that uses a contactor.</li> <li>Modular design simplifies assembly and installation.</li> </ul>		
	<b>11-BGX77-048</b>			
<b>11-G318-48</b>				

## EZ-SCREEN® Grid Kits



You can purchase a kit that contains an emitter and receiver of equal length and beam spacing; brackets; and optional interfacing solution and quick-disconnect cables. Detailed information about individual kit components is as follows.

- Emitter and Receivers ..... Page 28
- Interfacing Options..... 30
- Cables ..... 178 & 179
- Brackets ..... 190

A **partial listing** of kits is listed below; see Kit Model Key to order other variations.

Kit Model Number	Beams	Beam Spacing	Protected Height	Range	Supply Voltage	No. of Outputs	Output Options	Emitter & Receiver Connection	Interfacing Options	QD Cabling		
SGK4-300Q83-1RE25	4	300 mm	900 mm	20 m	24V dc	2 OSSD	Trip/Latch Selectable	Integral Mini QD without Test	IM-T-9A, 1 each	8 m, 2 each		
SGXLK4-300Q83-1RE25				70 m								
SGK3-400Q83-1RE25	3	400 mm	800 mm	20 m								
SGXLK3-400Q83-1RE25				70 m								
SGK3-533Q83-1RE25	3	533 mm	1066 mm	20 m								
SGXLK3-533Q83-1RE25				70 m								
SGK2-500Q83-1RE25	2	500 mm	500 mm	20 m								
SGXLK2-500Q83-1RE25				70 m								
SGK2-584Q83-1RE25				584 mm							584 mm	20 m
SGXLK2-584Q83-1RE25												70 m

## Kit Model Key

Model Style	Kit	No. of Beams	Beam Spacing	QD Options	Interfacing Options	QD Cabling Length Options
<b>SG</b>	<b>K</b>	<b>4</b>	<b>300</b>	<b>Q83</b>	<b>1</b>	<b>RE25</b>

**Model Style**  
**SG** = Safety Grid  
**SGXL** = Safety Grid Long Range

**No. of Beams**  
**2** = two beams  
**3** = three beams  
**4** = four beams

**Beam Spacing**  
300 mm  
400 mm  
500 mm  
533 mm  
584 mm

**Kit**  
**K** = Kit

**Receiver & Emitter QD Options**  
**Blank** = Receiver and emitter with wiring terminal chamber  
**Q85** = Receiver with integral 8-pin Mini-style QD  
Emitter with integral 5-pin Mini-style QD with Test  
**Q83** = Receiver with integral 8-pin Mini-style QD  
Emitter with integral 3-pin Mini-style QD  
**Q88E** = Receiver and emitter with integral 8-pin Euro-style QD

**QD Cabling Length Options**  
**RE15** = 5 m, 2 each  
**RE25** = 8 m, 2 each  
**R15E25** = 5 m (Receiver) & 8 m (Emitter)  
**R25E15** = 8 m (Receiver) & 5 m (Emitter)  
**RE50** = 15 m, 2 each  
**R15E50** = 5 m (Receiver) & 15 m (Emitter)  
**R50E15** = 15 m (Receiver) & 5 m (Emitter)  
**R25E50** = 8 m (Receiver) & 15 m (Emitter)  
**R50E25** = 15 m (Receiver) & 8 m (Emitter)  
**RE75** = 23 m, 2 each  
**RE100** = 30 m, 2 each

**Interfacing Options**  
**1** = IM-T-9A Interface Module, 1 each  
**2** = IM-T-11A Interface Module, 1 each  
**3** = 11-BG00-31-D-024 Contactors (10A), 2 each  
**4** = 11-BF16C01-024 Contactors (16A), 2 each

NOTE: Not all combinations are possible. Contact Banner Engineering Corp. for additional information and/or verification of valid kit model numbers.

## EZ-SCREEN® Point Kits



You can purchase a kit that contains an emitter and receiver of equal length; brackets; and optional interfacing solution and quick-disconnect cables. Detailed information about individual kit components is as follows.

- Emitter and Receivers .....Page 28
- Interfacing Options..... 30
- Cables .....178 & 179
- Brackets..... 190

A **partial listing** of kits is listed below; see Kit Model Key to order other variations.

Kit Model Number	Beams	Beam Spacing	Range	Supply Voltage	No. of Outputs	Output Options	Emitter & Receiver Connection	Interfacing Options	QD Cabling
SPK1-Q83-1RE25	1	N/A	20 m	24V dc	2 OSSD	Trip/Latch Selectable	Integral Mini QD without Test	IM-T-9A, 1 each	8 m, 2 each
SPXLK1-Q83-1RE25			70 m						

## Kit Model Key

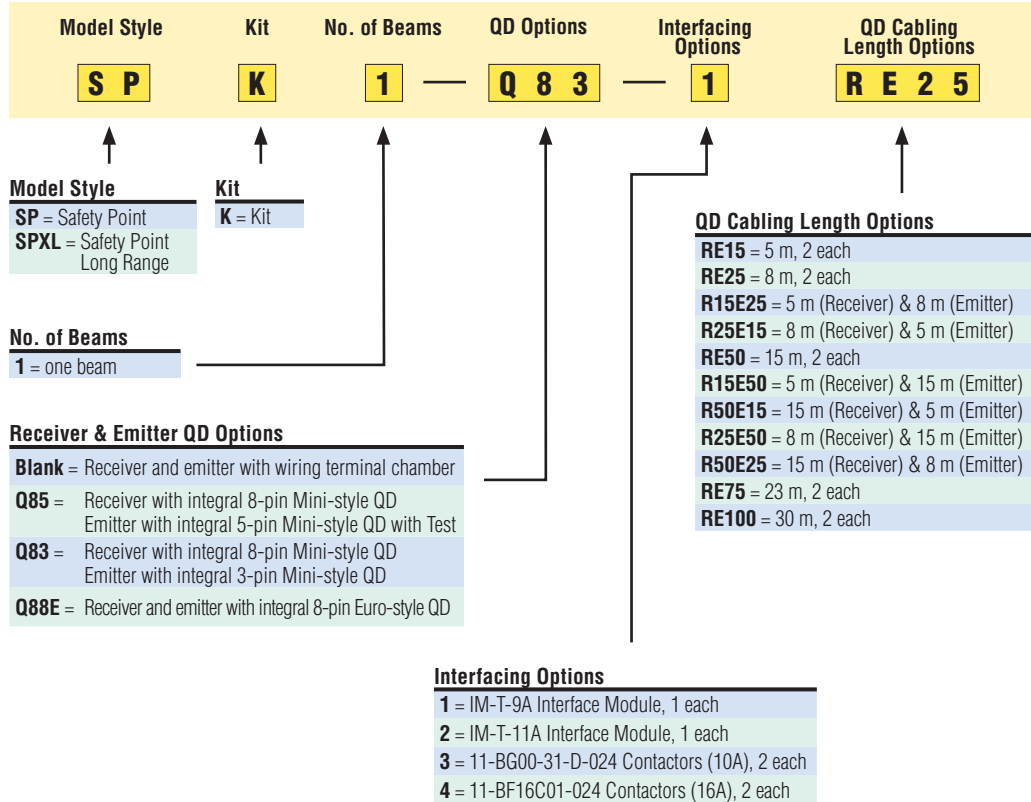

NOTE: Not all combinations are possible. Contact Banner Engineering Corp. for additional information and/or verification of valid kit model numbers.



## EZ-SCREEN® 14 &amp; 30 mm Resolution Specifications

<b>Supply Voltage at the Device*</b>	24V dc $\pm 15\%$ (SELV), $\pm 10\%$ max. ripple
<b>Supply Current</b>	<b>Emitter:</b> 100 mA max. <b>Receiver:</b> 275 mA max., exclusive of OSSD1 and OSSD2 loads (up to an additional 0.5A each)
<b>Response Time</b>	9 to 56 miliseconds <b>Cascade Safety Stop Interface (CSSI):</b> 40 milliseconds max.
<b>Remote Test Input (Optional – available only on model SLSE...Q5 emitters)</b>	Test Mode is activated either by applying a low signal (less than 3V dc) to emitter TEST #1 terminal for a minimum of 50 milliseconds, or by opening a switch connected between TEST #1 and TEST #2 for a minimum of 50 milliseconds. Beam scanning stops to simulate a blocked condition. A high signal at TEST #1 deactivates Test Mode. (See p/n 112852 for more information.) <b>High signal:</b> 10 to 30V dc <b>Low signal:</b> 0 to 3V dc <b>Input current:</b> 35 mA inrush, 10 mA max.
<b>Wavelength of Emitter Elements</b>	Infrared LEDs, 950 nm at peak emission
<b>EDM Input</b>	+24V dc signals from external device contacts can be monitored (one-channel, two-channel or no monitoring) via EDM1 and EDM2 terminals in the receiver. Monitored devices must respond within 200 milliseconds of an output change. <b>High signal:</b> 10 to 30V dc at 30 mA typical <b>Low signal:</b> 0 to 3V dc <b>Dropout time:</b> 200 milliseconds max.
<b>Reset Input</b>	The Reset input must be high for 0.25 to 2 seconds and then low to reset the receiver. <b>High signal:</b> 10 to 30V dc at 30 mA typical <b>Low signal:</b> 0 to 3V dc <b>Closed switch time:</b> 0.25 to 2 seconds
<b>Safety Outputs</b>	Two redundant solid-state 24V dc, 0.5 A max. sourcing OSSD (Output Signal Switching Device) safety outputs. (Use optional interface modules for ac or larger dc loads.) Capable of the Banner “Safety Handshake”. <b>ON-State voltage:</b> $\geq V_{in} - 1.5V$ dc <b>OFF-State voltage:</b> 1.2V dc max. (0-1.2V dc) <b>Max. load capacitance:</b> 1.0 $\mu$ F <b>Max. load inductance:</b> 10 H <b>Leakage current:</b> 0.50 mA maximum <b>Cable resistance:</b> 10 $\Omega$ maximum <b>OSSD test pulse width:</b> 100 to 300 microseconds <b>OSSD test pulse period:</b> 5 to 27 milliseconds (varies with number of beams) <b>Switching current:</b> 0-0.5 A
<b>Controls and Adjustments</b>	<b>Emitter:</b> <b>Scan Code selection:</b> 2-position switch (code 1 or 2). Factory default position is code 1. <b>Receiver:</b> <b>Scan Code selection:</b> 2-position switch (code 1 or 2). Factory default position is code 1. <b>Trip/Latch Output selection:</b> Redundant switches. Factory default position is T (Trip). <b>EDM/MPCE monitor selection:</b> 2-position switch selects between 1- or 2-channel monitoring. Factory default position is 2. <b>Reduced Resolution (2-beam Floating Blanking):</b> Redundant switches to enable. Factory default is OFF.
<b>Short Circuit Protection</b>	All inputs and outputs are protected from short circuits to +24V dc or dc common*
<b>Electrical Safety Class (IEC 61140: 1997)</b>	III
<b>Safety Rating</b>	Type 4 per IEC 61496-1, -2; Category 4 per ISO 13849-1 (EN 954-1)
<b>Operating Range</b>	<b>14 mm models:</b> 0.1 m to 6 m <b>30 mm models:</b> 0.1 m to 18 m Range decreases with use of mirrors and/or lens shields: <b>Lens shields</b> – approximately 10% less range per shield. <b>Glass-surface mirrors</b> – approximately 8% less range per mirror. See Accessory section for more information on a specific mirror, page 204.
<b>Ambient Light Immunity</b>	> 10,000 lux at 5° angle of incidence
<b>Effective Aperture Angle (EAA)</b>	Meets Type 4 requirements per IEC 61496-2, $\pm 2.5^\circ$ @ 3 m

\*The external voltage supply must be capable of buffering brief mains interruptions of 20 milliseconds, as specified in IEC/EN 60204-1.

## EZ-SCREEN® 14 &amp; 30 mm Resolution Specifications (cont'd)

<b>Enclosure</b>	<b>Materials:</b> Extruded aluminum housing with yellow polyester powder or nickel-plated finish and well-sealed, rugged die-cast zinc end caps, acrylic lens cover, copolyester access cover <b>Rating:</b> IEC IP65
<b>Operating Conditions</b>	<b>Temperature:</b> 0° to +55° C <b>Relative humidity:</b> 95% (non-condensing)
<b>Status Indicators</b>	<b>Emitter:</b> <b>One Bi-color (Red/Green) Status Indicator</b> – indicates operating mode, Lockout or power OFF condition <b>7-segment Diagnostic Indicator (1 digit)</b> – indicates proper operation, scan code or error code  <b>Receiver:</b> <b>Yellow Reset Indicator</b> – indicates whether system is ready for operation or requires a reset <b>Bi-Color (Red/Green) Status Indicator</b> – indicates general system and output status <b>Bi-Color (Red/Green) Zone Status Indicators</b> – indicates condition (clear or blocked beam) of a defined group of beams <b>7-Segment Diagnostic Indicator (3-digit)</b> – indicates proper operation, scan code or error code, total number of blocked beams
<b>Mounting Hardware</b>	Emitter and receiver each are supplied with a pair of swivel end-mounting brackets. Models longer than 900 mm also include a swivel center-mount bracket. Mounting brackets are 8-gauge cold-rolled steel, black zinc finish.
<b>Shock and Vibration</b>	EZ-SCREEN systems have passed vibration and shock tests according to IEC 61496-1. This includes vibration (10 cycles) of 10-55 Hz at 0.35 mm single amplitude (0.70 mm peak-to-peak) and shock of 10 g for 16 milliseconds (6,000 cycles).
<b>Certifications</b>	For a list of certifications see page 236.
<b>Wiring Diagrams</b>	WD001, WD002, WD003, WD004, WD009, WD010, WD011, WD012, WD013, WD014, WD015, WD016 (pp. 246-254)

## EZ-SCREEN® Grid &amp; Point Specifications

<b>Supply Voltage (V in)</b>	24V dc ±15%, 10% max. ripple
<b>Supply Current</b>	<b>Emitter:</b> 150 mA max. <b>Receiver:</b> 500 mA max., exclusive of OSSD1 and OSSD2 loads (up to an additional 0.5A each)
<b>Short Circuit Protection</b>	All inputs and outputs are protected from short circuits to +24V dc or dc common (except Emitter AUX power connections)
<b>Response Time</b>	24 milliseconds or less from interruption of light grid beam to safety outputs going to OFF-state
<b>Safety Rating</b>	Type 4 per IEC 61496-1, -2; Category 4 per ISO 13849-1 (EN 954-1)
<b>EDM Input</b>	+24V dc signals from external device contacts can be monitored (single-channel, dual-channel or no monitoring) via EDM1 and EDM2 terminals in the receiver. Monitored devices must respond within 200 milliseconds of an output change.
<b>Reset Input</b>	The Reset input must be high (10 to 30V dc at 30 mA) for 0.25 to 2 seconds and then low (less than 3V dc) to reset the receiver.
<b>Remote Test Input</b>	Test mode is activated either by applying a low signal (less than 3V dc) to emitter TEST1 terminal for a minimum of 50 milliseconds, or by opening a switch connected between TEST1 and TEST2 terminals for a minimum of 50 milliseconds. Beam scanning stops to simulate a blocked condition. A high signal (10 to 30V dc, 35 mA inrush, 10 mA max.) at TEST1 terminal deactivates Test mode and allows the emitter to operate normally. TEST1 and TEST2 are factory jumpered.
<b>Safety Outputs</b>	Two diverse-redundant solid-state 24V dc, 0.5 A max. sourcing OSSD (Output Signal Switching Device) safety outputs. (Use optional interface modules for ac or larger dc loads.) <b>ON-State voltage:</b> ≥Vin-1.5V dc <b>OFF-State voltage:</b> 1.2V dc max. <b>Max. load resistance:</b> 1000 ohm <b>Max. load capacitance:</b> 0.1 µF
<b>Controls and Adjustments</b>	<b>Emitter:</b> <b>Scan code selection:</b> 2-position switch (code 1 or 2). Factory default position is 1. <b>Receiver:</b> <b>Scan code selection:</b> 2-position switch (code 1 or 2). Factory default position is 1. <b>Trip/latch output selection:</b> redundant switches. Factory default position is L (latch) <b>EDM/MPCE monitor selection:</b> redundant switches select between 1- or 2-channel monitoring. Factory default position is 2.

## EZ-SCREEN® Grid &amp; Point Specifications (cont'd)

<b>Emitter/Receiver Operating Range</b>	<b>Short-range models:</b> 0.8 m to 20 m <b>Long-range models:</b> 15 m to 70 m Range decreases with use of mirrors and/or lens shields.
<b>Beam Spacing</b>	<b>Model SG...4-300:</b> 300 mm <b>Model SG...3-400:</b> 400 mm <b>Model SG...2-500:</b> 500 mm <b>Model SG...3-533:</b> 533.4 mm <b>Model SG...2-584:</b> 584.2 mm
<b>Beam Diameter</b>	25 mm
<b>Ambient Light Immunity</b>	> 10,000 lux at 5° angle of incidence
<b>Strobe Light Immunity</b>	Totally immune to one Federal Signal Corp. "Fireball" model FB2PST strobe
<b>Emitter Elements</b>	Infrared LEDs, 880 nm at peak emission
<b>Effective Aperture Angle (EAA)</b>	Meets Type 4 requirements per IEC 61496-2 <b>Short-range models:</b> ± 2.5° @ 3 m <b>Long-range models:</b> ± 2.5° @ 15 m
<b>Enclosure</b>	<b>Materials:</b> Extruded aluminum housings with yellow polyester powder finish and well-sealed, rugged molded PBT end caps, acrylic lens cover <b>Rating:</b> NEMA 4, 13; IEC IP65
<b>Operating Conditions</b>	<b>Temperature:</b> 0° to +50° C <b>Relative humidity:</b> 95% (non-condensing)
<b>Shock and Vibration</b>	EZ-SCREEN systems have passed vibration and shock tests according to IEC 61496-1 and -2. This includes vibration (10 cycles) of 10-55 Hz at 0.35 mm single amplitude (0.70 mm peak-to-peak) and shock of 10 g for 16 milliseconds (6,000 cycles).
<b>Status Indicators</b>	<p><b>7-Segment Diagnostic Indicators, Both Emitter and Receiver</b></p> <p><b>Dash (–)</b> = System is OK</p> <p><b>Error Codes</b> = See product manuals (p/n 68410 or 68413) for code definitions and recommended action</p> <p><b>Scan code setting</b> = Appears during power-up or after scan code is changed. (C1 or C2) (Temporary indication; normal display resumes within a few seconds.)</p> <p><b>Emitter:</b> One bi-color (red/green) Status indicator</p> <p><b>Green steady</b> = RUN mode</p> <p><b>Green single flashing</b> = TEST mode</p> <p><b>Red single flashing</b> = Lockout</p> <p><b>OFF</b> = No power to sensor</p> <p><b>Receiver:</b> Two System Status indicators, plus one bi-color (red/green) Beam Status indicator for each beam</p> <p><b>Yellow Reset Indicator</b></p> <p><b>ON steady</b> = RUN mode</p> <p><b>Double flashing</b> = Waiting for manual reset after power-up</p> <p><b>Single flashing</b> = Waiting for manual latch reset</p> <p><b>OFF</b> = No power to sensor or system is not ready for operation</p> <p><b>Bi-Color (Red/Green) Status Indicator</b></p> <p><b>Green steady</b> = Outputs ON</p> <p><b>Red steady</b> = RUN mode, outputs OFF</p> <p><b>Red single flashing</b> = Lockout</p> <p><b>OFF</b> = No power to sensor or system is not ready for operation</p> <p><b>Bi-Color (Red/Green) Beam Status Indicators</b></p> <p><b>Green steady</b> = Clear beam, strong signal</p> <p><b>Green flickering</b> = Clear beam, weak signal</p> <p><b>Red steady</b> = Beam blocked</p> <p><b>OFF</b> = No power to sensor or no scanning</p>
<b>Mounting Hardware</b>	Emitter and receiver each are supplied with a pair of swivel end mounting brackets. Mounting brackets are 8-gauge cold-rolled steel, black zinc finish.
<b>Cables and Connections</b>	Cables are user-supplied. Wiring terminals accommodate one 22 to 16 ga. wire or two wires up to 18 ga.; Pg13.5 wiring chamber access port capacity varies, depending on cable gland or strain relief fitting used. Supplied cable gland is for a cable diameter of 6 to 12 mm.
<b>Certifications</b>	For a list of certifications see page 236.
<b>Wiring Diagrams</b>	WD005, WD006, WD007, WD008, WD009, WD010, WD011, WD012, WD013, WD014, WD015, WD016 (pp. 248-254)

# PICO-GUARD™ Grids & Points

- Fiber optic elements are for use with PICO-GUARD Controllers and fiber optic cables in personnel safety and equipment-protection applications.
- Choices include compact 12 or 30 mm non-contact fiber optic Point elements, or Grid systems for perimeter and access guarding.
- Each fiber optic channel uses one Grid or Point pair (up to 4 pairs per controller).
- Grid system features rugged anodized aluminum construction, with 2, 3 or 4 beams and beam spacing from 300 to 584 mm.
- Each Point or Grid element can function as emitter or receiver, depending on installation.
- 12 mm Point has impact-resistant polycarbonate plastic construction.
- 30 mm Point has robust 304 stainless steel housing with tempered glass lens window.
- Models are available for use with three types of integral plastic optical fiber, in four lengths.
- Environmental rating is IEC IP65 for Grids and IP67 for Points.
- Grids and Points meet Type 4 per IEC 61496-2 and Safety Category 4 per ISO 13849-1 applications when used with a PICO-GUARD controller.
- Multiple mounting bracket options allow easy installation.
- Grid and Points are ATEX and FM approved for use in explosive environments when used with a PICO-GUARD controller.



CABLE GLANDS  
PAGE 189



BRACKETS  
PAGE 190



MIRRORS  
PAGE 204



STANDS  
PAGE 209



Grid Systems .....	Page 37
12 mm Point Systems .....	38
30 mm Point Systems .....	38



## PICO-GUARD™ Grid Systems

- Two-, three- or four-beam models
- Polished-end 7 mm PVC-coated integral fiber cable
- IEC IP65 rated
- Robust black anodized housing with field replaceable window
- MEK-resistant housing for paint booth applications
- Optional MEK-resistant conduit and cable gland (see page 189)
- Interchangeable as emitter or receiver with PICO-GUARD controller
- A complete system requires a controller (see page 108)



**PICO-GUARD Grid**



**Full View**



**Black Anodized Aluminum**



## PICO-GUARD™ Grid Systems

Model*	Beam Spacing	Protected Height	Housing Length (L)	Fiber Description**	Fiber Length	Maximum Range***	Data Sheet
SFG4-300C8	 300 mm	900 mm	1084 mm	Integral Polished-End, PVC Coated Fibers 7 mm diameter	2.4 m	31 m	69762
SFG4-300C15					4.5 m	27 m	
SFG4-300C25					7.5 m	23 m	
SFG4-300C50					15 m	15 m	
SFG4-300C100					30 m	7.0 m	
SFG3-400C8	 400 mm	800 mm	984 mm		2.4 m	31 m	
SFG3-400C15					4.5 m	27 m	
SFG3-400C25					7.5 m	23 m	
SFG3-400C50					15 m	15 m	
SFG3-400C100					30 m	7.0 m	
SFG3-533C8	 533 mm	1066 mm	1251 mm		2.4 m	31 m	
SFG3-533C15					4.5 m	27 m	
SFG3-533C25					7.5 m	23 m	
SFG3-533C50					15 m	15 m	
SFG3-533C100					30 m	7.0 m	



\* Order any two Grid optical elements with the same housing length.

\*\* MEK-resistant conduit is available to protect fiber (see page 189).

\*\*\* Maximum range is based on using an emitter and receiver with the same length fiber. Using an emitter and receiver with different length fibers may decrease or increase range. Using corner mirrors reduces range. See specifications on page 41 for detailed range information.

SAFETY LIGHT SCREENS

- EZ-SCREEN™
- PICO-GUARD™
- MICRO-SCREEN™
- MINI-SCREEN™
- EZ-SCREEN™ TYPE 2

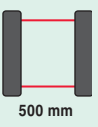
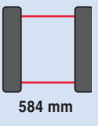

## PICO-GUARD™ Grid Systems (cont'd)

Model*	Beam Spacing	Protected Height	Housing Length (L)	Fiber Description**	Fiber Length	Maximum Range***	Data Sheet
SFG2-500C8	 500 mm	500 mm	684 mm	Integral Polished-End, PVC Coated Fibers 7 mm diameter	2.4 m	31 m	69762
SFG2-500C15					4.5 m	27 m	
SFG2-500C25					7.5 m	23 m	
SFG2-500C50					15 m	15 m	
SFG2-500C100					30 m	7.0 m	
SFG2-584C8	 584 mm	584 mm	768 mm		2.4 m	31 m	
SFG2-584C15					4.5 m	27 m	
SFG2-584C25					7.5 m	23 m	
SFG2-584C50					15 m	15 m	
SFG2-584C100					30 m	7.0 m	



\* Order any two Grid optical elements with the same housing length.  
 \*\* MEK-resistant conduit is available to protect fiber (see page 189).

\*\*\* Maximum range is based on using an emitter and receiver with the same length fiber. Using an emitter and receiver with different length fibers may decrease or increase range. Using corner mirrors reduces range. See specifications on page 41 for detailed range information.

## PICO-GUARD™ Point Systems

- 12 or 30 mm threaded barrel fiber optic interchangeable as emitter or receiver with PICO-GUARD controller
- Multiple Points create customized grid system
- Polished-end coated integral fiber
- Moisture and dirt resistant
- 304 stainless steel (30 mm) or impact-resistant polycarbonate (12 mm) housing
- Type 4 effective aperture angle (EAA)
- IEC IP67 rated
- A complete system requires a controller (see page 108)



**PICO-GUARD Point (30 mm Barrel)**

**PICO-GUARD Point (12 mm Barrel)**



# PICO-GUARD™ Point Systems

Model*	Housing Material	Orientation/Type	Fiber Description	Fiber Length	Maximum Range**	Data Sheet
SFP30SXP8	304 Stainless Steel	Straight 30 mm Barrel Mounting (25 mm beam diameter)	Integral Polished-End, PVC Coated Fibers 5 mm Diameter	2.4 m	29 m	111390
SFP30SXP15				4.5 m	24 m	
SFP30SXP25				7.5 m	22 m	
SFP30SXP50				15 m	14 m	
SFP30SXP100				30 m	8.5 m	
SFP30SXT8			Integral Polished-End, PTFE Coated Fibers 2.2 mm Diameter	2.4 m	29 m	
SFP30SXT15				4.5 m	24 m	
SFP30SXT25				7.5 m	22 m	
SFP30SXT50				15 m	14 m	
SFP30SXT100				30 m	8.5 m	
SFP30SS8			Integral Polished-End, Polyethylene Coated Fibers 2.2 mm Diameter	2.4 m	29 m	
SFP30SS15				4.5 m	24 m	
SFP30SS25				7.5 m	22 m	
SFP30SS50				15 m	14 m	
SFP30SS100	30 m	8.5 m				
SFP12XP8	Plastic	Straight 12 mm Barrel Mounting (9 mm beam diameter)	Integral Polished-End, PVC Coated Fibers 5 mm Diameter	2.4 m	6.4 m	111389
SFP12XP15				4.5 m	4.8 m	
SFP12XP25				7.5 m	3.4 m	
SFP12XP50				15 m	1.5 m	
SFP12PXT8			Integral Polished-End, PTFE Coated Fibers 2.2 mm Diameter	2.4 m	6.4 m	
SFP12PXT15				4.5 m	4.8 m	
SFP12PXT25				7.5 m	3.4 m	
SFP12PXT50				15 m	1.5 m	
SFP12PS8			Integral Polished-End, Polyethylene Coated Fibers 2.2 mm Diameter	2.4 m	6.4 m	
SFP12PS15				4.5 m	4.8 m	
SFP12PS25				7.5 m	3.4 m	
SFP12PS50				15 m	1.5 m	

\* Order any two Point optical elements with the same beam diameter.

\*\* Maximum range is based on using an emitter and receiver with the same length fiber. Using an emitter and receiver with different length fibers may decrease or increase range. Using corner mirrors reduces range. See specifications on page 41 for detailed range information.

SAFETY LIGHT SCREENS

EZ-SCREEN®

PICO-GUARD®

MICRO-SCREEN®

MINI-SCREEN®

EZ-SCREEN® TYPE 2





## PICO-GUARD™ Controller (required for a complete system)

Models	Description	Product Information	Data Sheet
	<b>SFCDT-4A1</b> <ul style="list-style-type: none"> <li>The four-optical-channel controller is available with or without auxiliary channel outputs.</li> <li>Two dual-channel Universal Safety Stop Interface (USSI) inputs can connect to other safeguarding devices or controllers.</li> <li>Two solid-state diverse-redundant 0.5 A maximum safety outputs (OSSDs).</li> </ul>	Page 108	69761
	<b>SFCDT-4A1C</b> <ul style="list-style-type: none"> <li>Redundant DIP switches determine whether power-up is auto or manual and whether output operation is trip or latch.</li> <li>Optional external device monitoring (EDM) allows the system to monitor the status of external devices such as MPCEs.</li> <li>If not needed, up to three optical channels can be disabled.</li> </ul>		

## PICO-GUARD™ Interfacing Products



Models	Description	Product Information	Data Sheet
<b>Interface Modules</b> 	<b>IM-T-9A (3 NO)</b> <ul style="list-style-type: none"> <li>Interface modules provide two or three normally open force-guided relay outputs rated at 6 A.</li> </ul>	Page 132	62822
	<b>IM-T-11A (2 NO/1 NC)</b> <ul style="list-style-type: none"> <li>PICO-GUARD monitors these interface modules when they are connected to the PICO-GUARD External Device Monitoring (EDM) inputs.</li> <li>Convenient plug-in terminal blocks on a 22.5 mm DIN-rail mountable housing are included.</li> </ul>		
<b>Muting Modules</b> 	<b>MM-TA-12B</b> <ul style="list-style-type: none"> <li>The Muting Module can be used with PICO-GUARD systems and can temporarily inhibit a Grid or Point so materials can safely pass through the beams without stopping the machinery.</li> </ul>	Page 123	63517
	<b>MMD-TA-12B</b> <ul style="list-style-type: none"> <li>The module uses redundant microcontroller-based logic.</li> </ul>		116390
	<b>MMD-TA-11B</b>		
<b>Contactors</b> 	<b>Mechanically Linked Contactors</b> <ul style="list-style-type: none"> <li>Pairs of contactors create safety stop circuits with two normally open contacts in series.</li> <li>PICO-GUARD can monitor the circuit because of the contacts' force-guided mechanically linked design.</li> </ul>	Page 186	111881
	<b>11-BG00-31-D-024</b>		
	<b>11-BF16C01-024</b>		
	<b>Aux. Contacts</b> <ul style="list-style-type: none"> <li>Contactors add 10 or 16 amp current carrying capability to any safety system.</li> </ul>		
	<b>11-BGX10-40</b>		
	<b>11-G484-30</b>		
	<b>Suppressors</b> <ul style="list-style-type: none"> <li>Auxiliary contacts add 3 or 4 normally open contacts.</li> <li>Suppressors extend the life of an actuating device that uses a contactor.</li> <li>Modular design simplifies assembly and installation.</li> </ul>		
<b>11-BGX77-048</b>			
<b>11-G318-48</b>			



## PICO-GUARD™ Grid & Point Systems Specifications

<b>Operating Range</b>	<p>Range information is based on use of the integral polished fibers. The use of SFA-FS Fiber Splice reduces range by 20%. Do not cut polished fiber ends unless absolutely necessary (if the end is damaged or contaminated, or must be cut to length). Use only the Model PFC-2 Fiber Cutter to cut fibers, when necessary. If a polished end is cut, the excess gain is reduced, the advantage of polishing is lost, and the operating range is reduced.</p>
	<p><b>12 mm Point:</b>  <b>Minimum operating range:</b> 150 mm  <b>Maximum operating range:</b> see table at right</p>
	<p><b>30 mm Point:</b>  <b>Minimum operating range:</b> 800 mm  <b>Maximum operating range:</b> see table at right</p>
	<p><b>Grids:</b>  <b>Minimum operating range:</b> 800 mm  <b>Maximum operating range:</b> see table at right</p>
<b>Beam Diameter</b>	<p><b>12 mm Point:</b> 9 mm  <b>30 mm Point:</b> 25 mm  <b>Grids:</b> 25 mm</p>
<b>Effective Aperture Angle (EAA)</b>	Type 4 per IEC 61496-2; $\pm 2.5^\circ$ @ 3 m when used with SFCDT-.
<b>Environmental Rating</b>	<p><b>Points:</b> IEC IP67  <b>Grids:</b> IEC IP65</p>
<b>Operating Conditions</b>	<p><b>Temperature:</b> 0° to +70° C      <b>Relative humidity:</b> 95% (non-condensing)</p>
<b>Construction</b>	<p><b>12 mm Point:</b> black polycarbonate plastic housing; polyethylene, PVC or PTFE coated fibers  <b>30 mm Point:</b> 304 stainless steel housing, glass window; polyethylene, PVC or PTFE coated fibers  <b>Grids:</b> black anodized aluminum housing and label; tempered glass window; zinc end caps; PVC coated fibers</p>
<b>Certifications</b>	For a list of certifications see page 236.

### 12 mm Point Maximum Operating Range

	SFP12..8	SFP12..15	SFP12..25	SFP12..50
SFP12..8	6.4 m	5.5 m	4.6 m	3 m
SFP12..15	5.5 m	4.8 m	4 m	2.7 m
SFP12..25	4.6 m	4 m	3.4 m	2.1 m
SFP12..50	3 m	2.7 m	2.1 m	1.5 m

### 30 mm Point Maximum Operating Range

	SFP30..8	SFP30..15	SFP30..25	SFP30..50	SFP30..100
SFP30..8	28.7 m	25.9 m	23.2 m	20.1 m	13.7 m
SFP30..15	25.9 m	24.4 m	22.9 m	19.5 m	12.8 m
SFP30..25	23.2 m	22.9 m	21.9 m	17.1 m	12.2 m
SFP30..50	20.1 m	19.5 m	17.1 m	14.0 m	11.0 m
SFP30..100	13.7 m	12.8 m	12.2 m	11.0 m	8.5 m

### Grid Maximum Operating Range

	SFG..8	SFG..15	SFG..25	SFG..50	SFG..100
SFG..8	31.1 m	29.0 m	26.5 m	21.6 m	14.9 m
SFG..15	29.0 m	27.1 m	24.7 m	20.1 m	14.0 m
SFG..25	26.5 m	24.7 m	22.6 m	18.3 m	12.8 m
SFG..50	21.6 m	20.1 m	18.3 m	14.9 m	10.4 m
SFG..100	14.9 m	14.0 m	12.8 m	10.4 m	7.0 m

## PICO-GUARD™ Fiber Optic Controller Specifications

See page 110.

# MICRO-SCREEN® Safety Light Screens

- Family is designed for light- to medium-duty production machinery.
- Full system includes emitter, receiver, controller and interconnecting cables. Order QD cable separately.
- Emitters and receivers feature ultra-compact housing with 19 or 32 mm resolution.
- Optional ESD-resistant housing is available.
- System includes floating blanking (one or two beam), selectable auto power-up, E-stop input and optional fixed blanking with push-button TEACH mode programming.
- Controllers offered with DeviceNet™ or muting



DeviceNet™ is a trademark of Rockwell Automation.

*MICRO-SCREEN 19 mm Emitters & Receivers. . . . .* Page 43  
*MICRO-SCREEN 32 mm Emitters & Receivers. . . . .* 44  
*MICRO-SCREEN Metal Box Controllers . . . . .* 45  
*MICRO-SCREEN DIN Module Controllers. . . . .* 46  
*MICRO-SCREEN Interfacing Products . . . . .* 48

## MICRO-SCREEN® Emitters & Receivers

- Ultra-compact housing to fit existing machinery
- Swivel bracket for easy alignment
- Twelve heights for Standard Series; seven for V Series
- 5-pin Euro QD connection standard
- QDU-... 5-pin Euro QD cables with "twisted pair" (see page 175)
- NEMA 4, 13; IEC IP65 housing

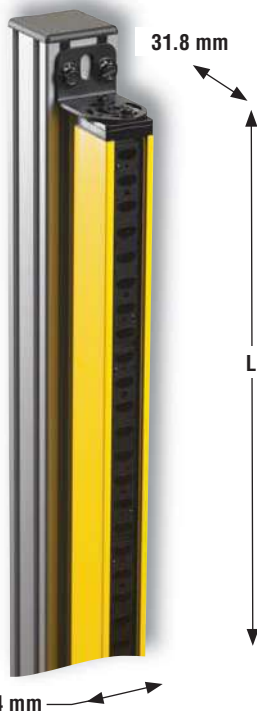

**MICRO-SCREEN Emitters & Receivers**



*Detailed Dimensions*

**Full View of Available Finishes**

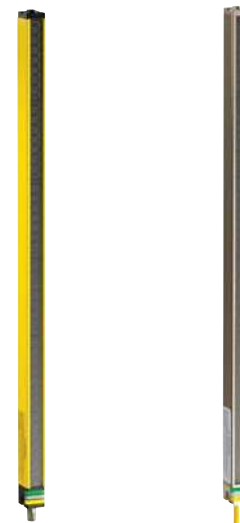

**Yellow Painted Aluminum**

**Nickel-Plated ESD**

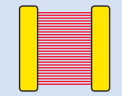

## MICRO-SCREEN® Series, Emitters & Receivers - 19 mm Resolution

Model*	Resolution	Defined Area	Housing Length (L)	Range	Connection**	Data Sheet
USE424Y USR424Y	 19 mm Resolution	102 mm	137 mm	9 m	5-Pin Euro QD	48753
USE824Y USR824Y		203 mm	239 mm			
USE1224Y USR1224Y		305 mm	340 mm			
USE1624Y USR1624Y		406 mm	442 mm			
USE2024Y USR2024Y		508 mm	544 mm			
USE2424Y USR2424Y		610 mm	645 mm			
USE2824Y USR2824Y		711 mm	747 mm			
USE3224Y USR3224Y		813 mm	848 mm			
USE3624Y USR3624Y		914 mm	950 mm			
USE4024Y USR4024Y		1016 mm	1052 mm			
USE4424Y USR4424Y		1118 mm	1153 mm			
USE4824Y USR4824Y		1219 mm	1255 mm			

 19 mm Resolution

\* Nickel-plated emitters and receivers used for ESD safe applications are available. Replace "Y" with "N" in the model number (example, **USE424N**).

\*\* For a 7.6 m integral cable, add I to model number (example, **USE424YI**).

For a 300 mm 5-Pin Euro Pigtail QD, add P2 to model number (example, **USE424YP2**). A model with a QD requires a mating cable (see page 175).

Note: Emitters (example, **USE424Y**) and receivers (example, **USR424Y**) are sold separately.

# MICRO-SCREEN® V-Series, Emitters & Receivers - 32 mm Resolution



Model*	Resolution	Defined Area	Housing Length (L)	Range	Connection**	Data Sheet
USE2412Y USR2412Y	 32 mm Resolution	610 mm	645 mm	9 m	5-Pin Euro QD	48753
USE3212Y USR3212Y		813 mm	848 mm			
USE4012Y USR4012Y		1016 mm	1052 mm			
USE4812Y USR4812Y		1219 mm	1255 mm			
USE5612Y USR5612Y		1422 mm	1458 mm			
USE6412Y USR6412Y		1626 mm	1661 mm			
USE7212Y USR7212Y		1829 mm	1864 mm			

 32 mm Resolution

\* Nickel-plated emitters and receivers used for ESD safe applications are available. Replace "Y" with "N" in the model number (example, **USE2412N**).

\*\* For a 7.6 m integral cable, add I to model number (example, **USE2412YI**).

For a 300 mm 5-Pin Euro Pigtail QD, add P2 to model number (example, **USE2412YP2**). A model with a QD requires a mating cable (see page 175).

Note: Emitters (example, **USE2412Y**) and receivers (example, **USR2412Y**) are sold separately.

### MICRO-SCREEN® Metal Box Controllers

- Welded steel box with polyester powder paint finish
- 115/230V ac or 24V dc supply voltage
- One- or two-beam floating blanking and selectable power-up
- Optional fixed blanking, muting and External Device Monitoring (EDM)
- Latch or trip output
- NEMA 13, IEC IP64 housing
- E-stop input



**MICRO-SCREEN Metal Box Controller (USCD-1T2 shown)**

**MICRO-SCREEN Metal Box Controller with Muting (USCC-1L2M shown)**

SAFETY LIGHT SCREENS

EZ-SCREEN®

PICO-GUARD®

MICRO-SCREEN®

MINI-SCREEN®

EZ-SCREEN®

TYPE 2

### MICRO-SCREEN® Series, Metal Box Controllers



Models	Supply Voltage	Output Type	Safety Outputs	Output Rating	Aux. Outputs**	Floating Blanking	Fixed Blanking	Data Sheet
USCT-2T2	24V dc	Trip	2 NO	4 amps	—	1- or 2-beam	Yes	51597
USCT-2T3				6 amps	1 NC		Yes	51597 & 59664
USCD-1T2	115/230V ac	Trip		4 amps	—		No	51597
USCD-1T3				6 amps	1 NC		No	51597 & 59664
USCD-2T2				4 amps	—		Yes	51597
USCD-2T3		6 amps		1 NC	Yes		51597 & 59664	
USCD-2T3E*		6 amps		1 NC	Yes			
USCD-1L2		Latch		4 amps	—		No	67173
USCD-2L2				4 amps	—		Yes	

NC = Normally Closed Relay, NO = Normally Open Relay  
 \* The suffix "E" adds external device monitoring input  
 \*\* All models contain one Reed Relay (see specifications page 53).



# MICRO-SCREEN® Series, Metal Box Controllers with Muting



Models	Supply Voltage	Output Type	Safety Outputs	Output Rating	Aux. Outputs*	Floating Blanking	Fixed Blanking	Data Sheet
	115/230V ac or 24V dc	Trip	2 NO	4 amps	—	1- or 2-beam	No	67690
				6 amps	1 NC		No	67690 & 59664
				4 amps	—		Yes	67690
				6 amps	1 NC		Yes	67690 & 59664
		Latch		4 amps	—		No	58764
				4 amps	—		Yes	58764
				6 amps	1 NC		Yes	58764 & 59644

NC = Normally Closed Relay, NO = Normally Open Relay  
 \* All models contain two Reed Relays (see specifications page 54-55).  
 Note: External Device Monitoring (EDM) standard on all controllers with muting.

## MICRO-SCREEN® DIN Module Controllers

- Polycarbonate housing with clear cover
- 24V dc supply voltage
- One- or two-beam floating blanking and selectable auto power-up
- Optional fixed blanking and External Device Monitoring (EDM)
- E-Stop input and latch or trip output
- NEMA 1; IP20 housing
- DeviceNet™ compatible
- Up to 4 normally open contacts to control up to two hazards

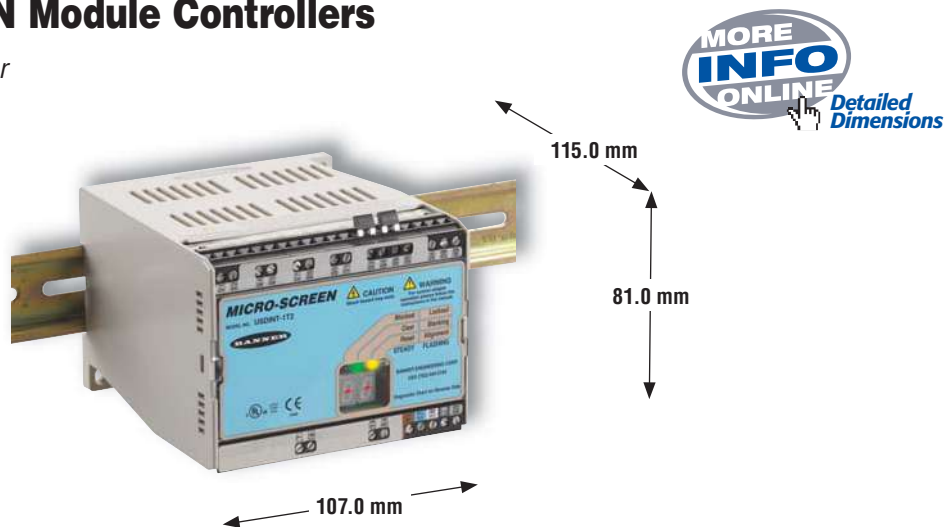

**MICRO-SCREEN DIN Module Controller (USDINT-1T2 shown)**

DeviceNet™ is a trademark of Rockwell Automation.



**MICRO-SCREEN® Series, DIN Module Controllers**

Models		Supply Voltage	Output Type	Safety Outputs**	Output Rating	Floating Blanking	Fixed Blanking	Data Sheet						
	USDINT-1T2	24V dc	Trip	2 NO	4 amps	1- or 2-beam	No	48753						
	USDINT-1T2E*			2 NO				53229						
	USDINT-1T4			4 NO				48753 & 55631						
	USDINT-2T2			2 NO				48753						
	USDINT-2T4			4 NO				48753 & 55631						
	USDINT-1L2		24V dc	Latch			2 NO	4 amps	1- or 2-beam	No	54202			
	USDINT-1L4						4 NO				54202 & 55631			
	USDINT-2L2						2 NO			54202				
	USDINT-2L4						4 NO			54202 & 55631				
	USDINT-1T2D			24V dc			Trip plus DeviceNet™			2 NO	4 amps	1- or 2-beam	No	48753 & 51699
	USDINT-1T4D	4 NO			48753, 51699 & 55631									
	USDINT-2T2D	2 NO			48753 & 51699									
	USDINT-2T4D	4 NO			48753, 51699 & 55631									
	USDINT-1L2D	24V dc			Latch plus DeviceNet™	2 NO	4 amps			1- or 2-beam			No	54202 & 54205
	USDINT-1L4D					4 NO								54202, 54205 & 55631
	USDINT-2L2D		2 NO			54202 & 54205								
	USDINT-2L4D		4 NO			54202, 54205 & 55631								

NC = Normally Closed Relay, NO = Normally Open Relay

\* The suffix "E" adds external device monitoring input

\*\* In addition to safety outputs, all models contain one non-safety Reed Relay auxiliary output (see specifications pages 55-57).

DeviceNet™ is a trademark of Rockwell Automation.



# MICRO-SCREEN® Interfacing Products

	Models	Description	Product Information	Data Sheet	
<b>Muting Modules</b>		<b>MM-TA-12B</b>	Page 123	63517	
		<b>MMD-TA-12B</b>		<ul style="list-style-type: none"> <li>The Muting Module temporarily inhibits a safety light screen so materials can safely pass through the screen without stopping the machinery.</li> <li>The module uses redundant microcontroller-based logic.</li> </ul>	116390
		<b>MMD-TA-11B</b>			
<b>Contactors</b>		<b>Mechanically Linked Contactors</b>	Page 186	111881	
		<b>11-BG00-31-A12060</b>			
		<b>11-BG00-31-D-024</b>			
		<b>11-BF1601-12060</b>			
		<b>11-BF16C01-024</b>			
		<b>Aux. Contacts</b>			
		<b>11-BGX10-40</b>			
		<b>11-G484-30</b>			
		<b>Suppressors</b>			
		<b>11-BGX77-048</b>			
		<b>11-BGX77-240</b>			
<b>11-G318-48</b>					
<b>11-G477-240</b>					

# MICRO-SCREEN® Metal Box Controller Kits



You can purchase a kit that contains an emitter and receiver of equal length and range; standard mounting brackets; and a pair of quick-disconnect cables. Detailed information about individual kit components is as follows.

- Metal Box Controllers ..... Page 45
- Emitter and Receivers ..... 43
- Cables ..... 175
- Brackets ..... 190

A **partial listing** of kits is listed below; see Kit Model Key to order other variations.

Kit Model Number	Sensor Housing		Defined Area	Resolution	Beams Per Foot	Range	Supply Voltage	Blanking	Output Type	Number of Outputs	QD Cabling
	Yellow	Nickel-Plated									
USK2T24243C5Y	•		610 mm	19 mm	24	9 m	24V dc	Fixed & Floating	Trip	2 NO Safety Outputs & 1 NC Aux.	8 m, 2 each
USK2T24123C5Y				32 mm	12						
USK2T24243C5N		•		19 mm	24						
USK2T24123C5N				32 mm	12						
USK2D24243C5Y	•			19 mm	24	115/230V ac					
USK2D24123C5Y				32 mm	12						
USK2D24243C5N		•		19 mm	24						
USK2D24123C5N				32 mm	12						

NC = Normally Closed Relay, NO = Normally Open Relay

## Kit Model Key

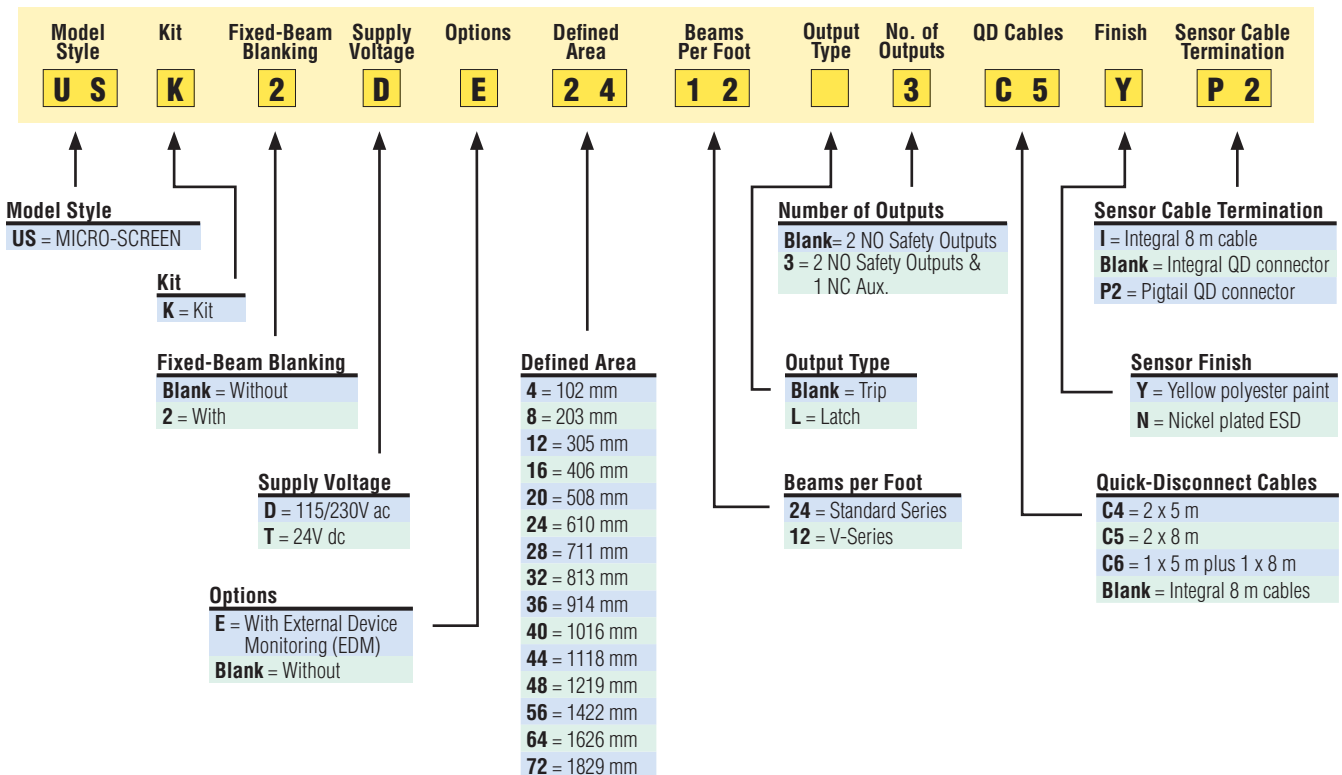

NOTE: Not all combinations are possible. Contact Banner Engineering Corp. for additional information and/or verification of valid kit model number.

# MICRO-SCREEN® Metal Box Controller with Muting Kits



You can purchase a kit that contains an emitter and receiver of equal length and range; standard mounting brackets; and a pair of quick-disconnect cables. Detailed information about individual kit components is as follows.

- Metal Box Controllers with Muting ..... Page 46
- Emitter and Receivers ..... 43
- Cables ..... 175
- Brackets ..... 190

A **partial listing** of kits is listed below; see Kit Model Key to order other variations.

Kit Model Number	Sensor Housing		Defined Area	Resolution	Beams Per Foot	Range	Supply Voltage	Blanking	Output Type	Number of Outputs	QD Cabling
	Yellow	Nickel-Plated									
USK2CM2424L3C5Y	•		610 mm	19 mm	24	9 m	115/230V ac or 24V dc	Fixed & Floating	Latch	2 NO Safety Outputs & 1 NC Aux.	8 m, 2 each
USK2CM2412L3C5Y				32 mm	12						
USK2CM2424L3C5N		•		19 mm	24						
USK2CM2412L3C5N				32 mm	12						

NC = Normally Closed Relay, NO = Normally Open Relay

## Kit Model Key

Model Style	Kit	Fixed-Beam Blanking	Supply Voltage	Muting	Defined Area	Beams Per Foot	Output Type	No. of Outputs	QD Cables	Finish	Sensor Cable Termination
<b>U S</b>	<b>K</b>	<b>2</b>	<b>C</b>	<b>M</b>	<b>2 4</b>	<b>1 2</b>	<b>L</b>	<b>3</b>	<b>C 5</b>	<b>Y</b>	<b>P 2</b>

**Model Style**  
US = MICRO-SCREEN

**Kit**  
K = Kit

**Fixed-Beam Blanking**  
Blank = Without  
2 = With

**Supply Voltage**  
C = 115/230V ac or 24V dc

**Muting**  
M = With

**Defined Area**  
4 = 102 mm  
8 = 203 mm  
12 = 305 mm  
16 = 406 mm  
20 = 508 mm  
24 = 610 mm  
28 = 711 mm  
32 = 813 mm  
36 = 914 mm  
40 = 1016 mm  
44 = 1118 mm  
48 = 1219 mm  
56 = 1422 mm  
64 = 1626 mm  
72 = 1829 mm

**Beams per Foot**  
24 = Standard Series  
12 = V-Series

**Output Type**  
Blank = Trip  
L = Latch

**Number of Outputs**  
Blank = 2 NO Safety Outputs  
3 = 2 NO Safety Outputs & 1 NC Aux.

**QD Cables**  
C4 = 2 x 5 m  
C5 = 2 x 8 m  
C6 = 1 x 5 m plus 1 x 8 m  
Blank = Integral 8 m cables

**Finish**  
Y = Yellow polyester paint  
N = Nickel plated ESD

**Sensor Cable Termination**  
I = Integral 8 m cable  
Blank = Integral QD connector  
P2 = Pigtail QD connector

NOTE: Not all combinations are possible. Contact Banner Engineering Corp. for additional information and/or verification of valid kit model number.



# MICRO-SCREEN® DIN Module Controller Kits



You can purchase a kit that contains an emitter and receiver of equal length and range; standard mounting brackets; and a pair of quick-disconnect cables. Detailed information about individual kit components is as follows.

- Metal DIN Box Controllers . . . . . Page 47
- Emitter and Receivers . . . . . 43
- Cables . . . . . 175
- Brackets . . . . . 190

A **partial listing** of kits is listed below; see Kit Model Key to order other variations.

Kit Model Number	Sensor Housing		Defined Area	Resolution	Beams Per Foot	Range	Supply Voltage	Blanking	Output Type	Number of Outputs	QD Cabling
	Yellow	Nickel-Plated									
USDK2T2424C5Y	•		610 mm	19 mm	24	9 m	24V dc	Fixed & Floating	Trip	2 NO Safety Outputs	8 m, 2 each
USDK2T2412C5Y				32 mm	12						
USDK2T2424C5N		•		19 mm	24						
USDK2T2412C5N				32 mm	12						
USDK2T2424C5Y	•			19 mm	24						
USDK2T2412C5Y				32 mm	12						
USDK2T2424C5N		•		19 mm	24						
USDK2T2412C5N				32 mm	12						

NC = Normally Closed Relay, NO = Normally Open Relay

## Kit Model Key

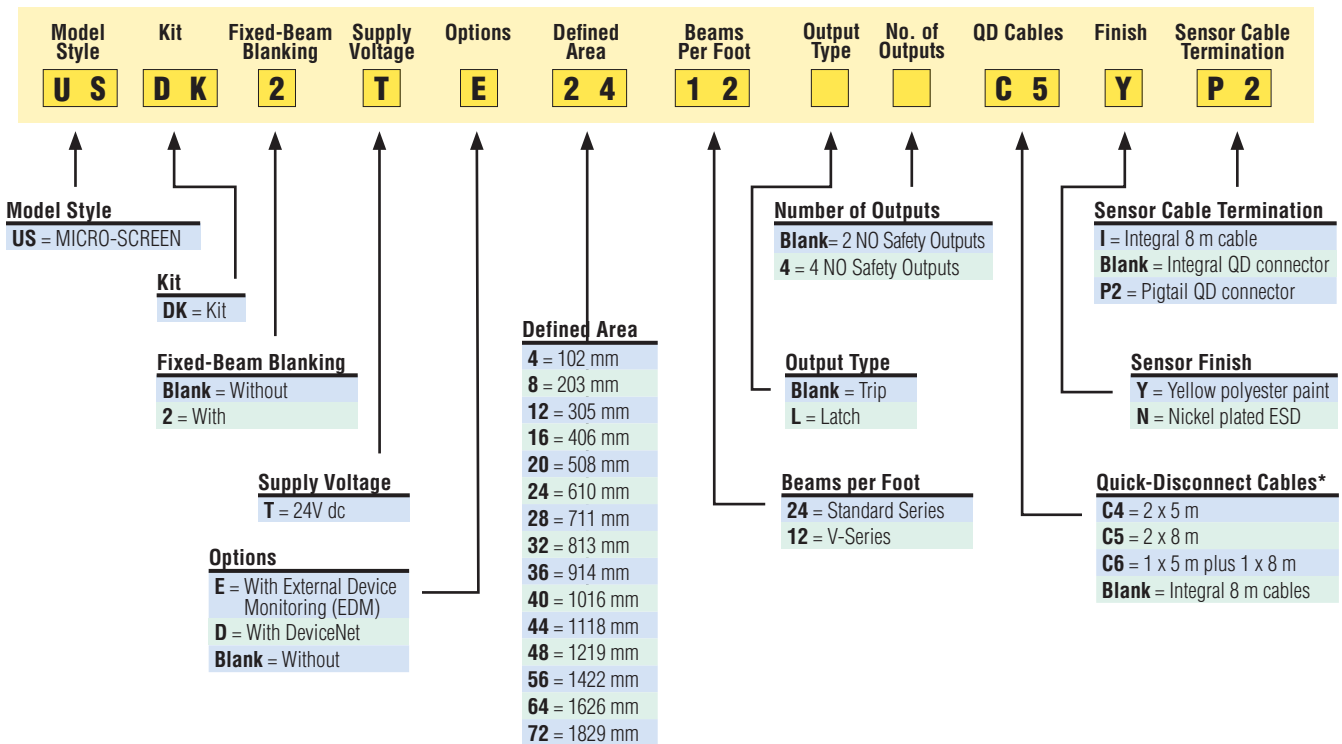

NOTE: Not all combinations are possible. Contact Banner Engineering Corp. for additional information and/or verification of valid kit model number.

## MICRO-SCREEN® Emitter &amp; Receiver Specifications

<b>Emitter/Receiver Separation</b>	<b>4" to 48" Emitters and Receivers:</b> 150 mm to 9 m <b>56" to 72" Emitters and Receivers:</b> 150 mm to 6 m
<b>Minimum Object Sensitivity</b>	<b>Standard Series:</b> 19.1 mm floating blanking OFF 31.8 mm 1-beam floating blanking ON 44.5 mm 2-beam floating blanking ON <b>V-Series:</b> 31.8 mm floating blanking OFF 57.5 mm 1-beam floating blanking ON 82.6 mm 2-beam floating blanking ON
<b>Response Time</b>	<b>Light Screens:</b> Less than 38 milliseconds (less than 48 milliseconds with muting option) <b>E-Stop:</b> Less than 15 milliseconds
<b>Self-Checking Interval</b>	20 milliseconds
<b>Ambient Light Immunity</b>	>10,000 lux at 5° angle of incidence
<b>Strobe Light Immunity</b>	Totally immune to one Federal Signal Corp. "Fireball" model FB2PST strobe.
<b>Emitter Elements</b>	Infrared LEDs; 880 nm peak emission
<b>Status Indicators</b>	<b>Emitter:</b> Green LED indicator for power ON indication <b>Receiver:</b> Red, yellow and green status indicators with the same functions as those on the left side of the control box (see Control Box Specifications, pages 53-57). Yellow also indicates alignment. Indicators are visible on three sides of receiver or emitter base.
<b>Emitter and Receiver Enclosures</b>	<b>Materials:</b> Aluminum extrusion with yellow polyester paint or nickel-plated finish <b>Rating:</b> NEMA 4, 13; IEC IP65
<b>Mounting Hardware</b>	Emitter and receiver each are supplied with a pair of swivel end mounting brackets. (Emitters and receivers 711 to 914 mm long are supplied with one center support bracket; emitters and receivers 1016 to 1829 mm long are supplied with two center brackets.) Mounting brackets are 13-gauge cold-rolled black zinc chromate finished steel.
<b>Cables</b>	<b>Emitters and Receivers with Integral Cables (USE/USRxxxYI):</b> Cables are 7.6 m long and measure 8.1 mm in diameter. Conductors are 20-gauge. Cables are shielded and PVC-jacketed.  <b>Emitters and Receivers with Integral (USE/USRxxxY) or Pigtail (USE/USRxxxYP2) Quick Disconnect:</b> Pigtail QD connectors have a 300 mm long cable, terminated with a 5-pin Euro-style quick-disconnect fitting. Mating interconnect cables are ordered separately (unless a MICRO-SCREEN kit is ordered, see Models and Accessories, page 175), and are available in lengths of 4.5 m, 7.6 m, and 15 m.  NOTE: Contact factory when cable length exceeding 15 m is required. Use only Banner cables, which incorporate a shielded "twisted pair" for noise immunity on RS485 data communications lines. Use of other cables may result in "nuisance" trips or lockouts.
<b>Optical Performance</b>	This system meets $\pm 2.5^\circ$ requirements of IEC 61496-2 section 5.2.9 (Type 4)
<b>Operating Conditions</b>	<b>Temperature:</b> 0° to +50° C <b>Relative humidity:</b> 95% maximum (non-condensing)
<b>Certifications</b>	For a list of certifications see page 236.

## MICRO-SCREEN® Metal Box Controller Specifications

<b>System Power Requirements</b>	<b>USCD-.. models:</b> 115/230V ac ±15% (50/60 Hz), 55 VA <b>USCT-.. models:</b> 24V dc ±15% @ 1.5 amp max.												
<b>Fuse Rating (F2)</b>	<b>115V ac:</b> 1 amp, 250V ac; <b>230V ac:</b> 0.5 amp, 250V <b>24V dc:</b> 2 amp, 250V												
<b>Response Time</b>	<b>Light Screens:</b> Less than 38 milliseconds <b>E-Stop:</b> Less than 15 milliseconds												
<b>Status Indicators</b>	<b>Control Box and Receiver:</b> <table border="0"> <tr> <td></td> <td><b>Solid LED</b></td> <td><b>Flashing LED</b></td> </tr> <tr> <td><b>Red</b></td> <td>BLOCKED/LATCHED</td> <td>LOCKOUT</td> </tr> <tr> <td><b>Green</b></td> <td>CLEAR</td> <td>BLANKING ON</td> </tr> <tr> <td><b>Yellow</b></td> <td>RESET</td> <td>Double Flash = Waiting for System Key RESET at Power-up Single Flash = ALIGNMENT. Flash rate increases with the number of sensing beams "made", solid yellow when aligned and defined area is clear</td> </tr> </table>		<b>Solid LED</b>	<b>Flashing LED</b>	<b>Red</b>	BLOCKED/LATCHED	LOCKOUT	<b>Green</b>	CLEAR	BLANKING ON	<b>Yellow</b>	RESET	Double Flash = Waiting for System Key RESET at Power-up Single Flash = ALIGNMENT. Flash rate increases with the number of sensing beams "made", solid yellow when aligned and defined area is clear
	<b>Solid LED</b>	<b>Flashing LED</b>											
<b>Red</b>	BLOCKED/LATCHED	LOCKOUT											
<b>Green</b>	CLEAR	BLANKING ON											
<b>Yellow</b>	RESET	Double Flash = Waiting for System Key RESET at Power-up Single Flash = ALIGNMENT. Flash rate increases with the number of sensing beams "made", solid yellow when aligned and defined area is clear											
<b>Diagnostic Indicator</b>	Two-digit numeric display indicates cause of lockout condition and total number of beams blocked.												
<b>Controls and Adjustments</b>	Keyed RESET of system lockout and latched conditions Floating blanking selection switches and fixed blanking programming switches Auto Power-up On-Off switches												
<b>E-Stop Switch Input</b>	The Emergency Stop switch must offer two normally closed contacts and be capable of switching 50 mA @ 30V dc. Total resistance, including wiring and all switches, must not exceed 30 Ω for proper operation. Functional stop category 0 per NFPA 79 and EN 418, Safety Category 4 per EN 954-1. Simultaneity requirement less than 100 milliseconds.												
<b>External Device Monitoring (EDM) Input*</b>	Terminals must open within 200 milliseconds of the FSD outputs closing (i.e., a clear condition) and must close within 200 milliseconds of the FSD outputs opening (i.e., a blocked condition) or a lockout will occur. The monitoring contacts must be forced-guided (or captive contact) to maintain control reliability of the machine control circuit and must be capable of reliably switching 15 to 50V dc at 20 to 100 mA.												
<b>Test Input</b>	Terminals must be closed for a minimum of 0.05 seconds in order to guarantee a test input signal. The switching device used must be capable of switching 15-50V dc at 20 to 100 mA.												
<b>Reset Input</b>	Terminals must be closed for a minimum of 0.5 seconds in order to guarantee a reset. The switching device must be capable of switching 15-50V dc at 20-100 mA.												
<b>Auxiliary Monitor Relay</b>	Reed relay; 125V ac or dc max., 500 mA max. (10 VA max., resistive load)												
<b>Safety Outputs</b>	Forced-guided contact relay (resistive load). <b>USCD-..2 &amp; USCT-..2:</b> FSD1 & 2, SSD = 250V ac max., 4 amp max. <b>USCD-..3 &amp; USCT-..3:</b> FSD1 & 2, CNC = 250V ac max., 6 amp max. SSD = 250V ac max., 4 amp max. <b>Mechanical life:</b> 10,000,000 operations (minimum). <b>Electrical life:</b> 100,000 operations (typical @ 1.0 kVA switching power). <i>Arc suppression is recommended when switching inductive loads.</i>												
<b>Enclosure</b>	<b>Material:</b> Welded steel box with black polyester powder paint finish <b>Rating:</b> NEMA 13; IEC IP64												
<b>Operating Conditions</b>	<b>Temperature:</b> 0° to +50° C <b>Relative humidity:</b> 95% maximum (non-condensing)												
<b>FMEA Tested</b>	Per requirements IEC 61496-1 (type 4)												
<b>Applications Notes</b>	Use of fixed blanking requires sensors with 16 or more light beams. Up to 12 beams or 30% of the total number of beams in the array may be blanked, whichever is less. Call factory for applications assistance if a greater number of blanked beams is required.												
<b>Certifications</b>	For a list of certifications see page 236.												
<b>Wiring Diagrams</b>	<b>2 FSDs, 1 SSD and Power Monitoring:</b> WD017 (p. 255)												

\* External Device Monitoring (EDM) models only.

## MICRO-SCREEN® Metal Box Controller with Muting Specifications

<b>System Power Requirements</b>	115V ac (50/60Hz) ± 15% @ 500 mA (50 VA), 230V ac (50/60Hz) ± 15% @ 250 mA (50 VA), or 24V dc ±15%, 10% max. ripple, @ 2.5 A (60 W)																								
<b>Fuse Rating (F2)</b>	<b>115V ac:</b> 1.0 A ac @ 250V ac (supplied) <b>230V ac:</b> 500 mA @ 250V ac <b>+24V dc:</b> Internal resettable																								
<b>Response Time</b>	<b>Light Screen:</b> Less than 48 milliseconds <b>E-Stop:</b> Less than 15 milliseconds																								
<b>Status LED Indicators</b>	<p><b>Light Screen Indicators (left column of LEDs):</b></p> <table border="0"> <tr> <td></td> <td><b>Solid LED</b></td> <td><b>Flashing LED</b></td> </tr> <tr> <td><b>Red</b></td> <td>BLOCKED/LATCHED</td> <td>LOCKOUT</td> </tr> <tr> <td><b>Green</b></td> <td>CLEAR</td> <td>BLANKING ON</td> </tr> <tr> <td><b>Yellow</b></td> <td>RESET</td> <td>Double Flash = Waiting for Single Flash = ALIGNMENT. Flash rate increases with the number of sensing beams "made", solid yellow when aligned and defined area is clear</td> </tr> </table> <p><b>System Indicators (right column of LEDs):</b></p> <table border="0"> <tr> <td></td> <td><b>Solid LED</b></td> <td><b>Flashing LED</b></td> </tr> <tr> <td><b>Red</b></td> <td>OVERRIDE</td> <td>LOCKOUT</td> </tr> <tr> <td><b>Green</b></td> <td>OUTPUT ON (FSD1 &amp; FSD2 closed)</td> <td>(Not Applicable)</td> </tr> <tr> <td><b>Yellow</b></td> <td>RESET (System)</td> <td>Double Flash = Waiting for System Key Reset at Power-up Single Flash = Waiting for System Key Reset at latched condition (manual reset of system after blockage has been removed)</td> </tr> </table>		<b>Solid LED</b>	<b>Flashing LED</b>	<b>Red</b>	BLOCKED/LATCHED	LOCKOUT	<b>Green</b>	CLEAR	BLANKING ON	<b>Yellow</b>	RESET	Double Flash = Waiting for Single Flash = ALIGNMENT. Flash rate increases with the number of sensing beams "made", solid yellow when aligned and defined area is clear		<b>Solid LED</b>	<b>Flashing LED</b>	<b>Red</b>	OVERRIDE	LOCKOUT	<b>Green</b>	OUTPUT ON (FSD1 & FSD2 closed)	(Not Applicable)	<b>Yellow</b>	RESET (System)	Double Flash = Waiting for System Key Reset at Power-up Single Flash = Waiting for System Key Reset at latched condition (manual reset of system after blockage has been removed)
	<b>Solid LED</b>	<b>Flashing LED</b>																							
<b>Red</b>	BLOCKED/LATCHED	LOCKOUT																							
<b>Green</b>	CLEAR	BLANKING ON																							
<b>Yellow</b>	RESET	Double Flash = Waiting for Single Flash = ALIGNMENT. Flash rate increases with the number of sensing beams "made", solid yellow when aligned and defined area is clear																							
	<b>Solid LED</b>	<b>Flashing LED</b>																							
<b>Red</b>	OVERRIDE	LOCKOUT																							
<b>Green</b>	OUTPUT ON (FSD1 & FSD2 closed)	(Not Applicable)																							
<b>Yellow</b>	RESET (System)	Double Flash = Waiting for System Key Reset at Power-up Single Flash = Waiting for System Key Reset at latched condition (manual reset of system after blockage has been removed)																							
<b>Diagnostic Displays</b>	<p><b>Light Screen Diagnostic Display (left window)</b> is a two-digit numeric display that indicates the cause of lockout conditions and total number of beams blocked.</p> <p><b>System Diagnostic Display (right window)</b> is a two-digit numeric display that indicates the cause of lockout conditions and the amount of time, in seconds, remaining for the backdoor timer.</p>																								
<b>Controls and Adjustments</b>	<ul style="list-style-type: none"> <li>• Light Screen Key Reset after power-up and light screen lockouts</li> <li>• Selection switches to enable floating blanking</li> <li>• Program switches to enable fixed blanking (USCC-2.. only)</li> <li>• Light Screen and System Auto Power-up selection switches</li> <li>• System Key Reset after power-up, system lockouts, and latched conditions</li> <li>• Selection switches for Monitored or Non-Monitored Muting indicator</li> <li>• Selection switches for One-Way or Two-Way (directional/non-directional) Muting</li> <li>• Selection switches for One-Channel or Two-Channel Monitoring (EDM)</li> <li>• Selection switches for Backdoor Timer settings and Mute-on-Power-Up</li> </ul>																								
<b>E-Stop Switch Input</b>	The Emergency Stop switch must offer two normally closed contacts and be capable of switching 50 mA @ 30V dc. Total resistance, including wiring and all switches, must not exceed 30 Ω for proper operation. Functional stop category 0 per NFPA 79 and EN 418, Safety Category 4 per EN 954-1. Simultaneity requirement less than 100 milliseconds.																								
<b>Light Screen Test Input</b>	Terminals must be closed for a minimum of 0.05 seconds in order to guarantee a test. The switching device must be capable of switching 15-50V dc at 20-100 mA.																								
<b>Light Screen and System Reset Inputs</b>	Terminals must be closed for a minimum of 0.5 seconds in order to guarantee a reset. The switching device must be capable of switching 15-50V dc at 20-100 mA.																								
<b>External Device Monitoring (EDM) Input(s)</b>	Two pairs of terminals are provided to monitor the state of external devices that are being controlled by the FSD outputs. The device must be capable of switching 15-50V dc at 20-100 mA.																								
<b>Mute Enable Input</b>	Terminals must be closed in order to start a mute; opening this input after mute has begun has no effect. The switching device must be capable of switching 15-50V dc at 20-100mA.																								
<b>Override Inputs</b>	The two-channel inputs must be closed within 3 seconds of each other (simultaneity requirement) and held closed during the 10-second Override. To initiate a subsequent Override, open both channels, wait 3 seconds, and then re-close both channels (within 3 seconds). The switching devices must be capable of switching 15-50V dc at 20-100 mA.																								
<b>Muting Device Input</b>	The muting devices work in pairs (M1 and M2, M3 and M4) and are required to be "closed" within 3 seconds of each other (simultaneity requirement) to initiate a mute (assuming all other conditions are met). Each muting device must be capable of switching 15-50V dc at 20-100 mA.																								
<b>Light Screen and System Aux. Monitor Relay Outputs</b>	Reed relay; 125V ac/dc max at 500 mA max. (10 VA maximum, resistive load)																								

**MICRO-SCREEN® Metal Box Controller with Muting Specifications (cont'd)**

<b>Safety Outputs</b>	Forced-guided contact relay (resistive load). <b>USCC-..2:</b> FSD1 & 2, SSD = 250V ac max., 4 amp max. <b>USCC-..3:</b> FSD1 & 2, CNC = 250V ac max., 6 amp max. SSD = 250V ac max., 4 amp max. <b>Mechanical life:</b> 10,000,000 operations (minimum). <b>Electrical life:</b> 100,000 operations (typical @ 1.0 kVA switching power). <i>Arc suppression is recommended when switching inductive loads.</i>
<b>Mute Lamp Output</b>	A monitored or non-monitored (selectable) sinking output. If monitoring has been selected, the current draw must be within 10 mA to 360 mA. <b>Max. switching voltage:</b> 30V dc <b>Max. switching current:</b> 360 mA <b>Max. switching current:</b> 10 mA <b>Saturation voltage:</b> ≤ 1.5V dc
<b>Auxiliary DC Supply Output</b>	24V dc ± 25%, 500 mA max
<b>Enclosure</b>	<b>Material:</b> Welded steel box with black polyester powder paint finish. <b>Rating:</b> NEMA 13; IEC IP64
<b>Operating Conditions</b>	<b>Temperature:</b> 0° to +50° C <b>Relative humidity:</b> 95% maximum (non-condensing)
<b>FMEA Tested</b>	Per requirements of IEC 61496-1 (type 4)
<b>Applications Notes</b>	Use of fixed blanking requires sensors with 16 or more light beams. Up to 12 beams or 30% of the total number of beams in the array may be blanked, whichever is less. Call factory for applications assistance if a greater number of blanked beams is required.
<b>Certifications</b>	For a list of certifications see page 236.
<b>Wiring Diagrams</b>	<b>2 FSDs and 2-Channel EDM:</b> WD018 (p. 255)

**MICRO-SCREEN® DIN Module Controller Specifications**

<b>System Power Requirements</b>	24V dc ±15%, 10% max. ripple, 1.5 amps max.												
<b>Fuse Rating</b>	2 amp, 250 V (3 AG or 5 x 20 mm slow blow)												
<b>Response Time</b>	<b>Light Screens:</b> Less than 38 milliseconds <b>E-Stop:</b> Less than 15 milliseconds												
<b>Status Indicators (on control module and receiver)</b>	<b>Control Box and Receiver:</b> <table border="0"> <tr> <td></td> <td><b>Solid LED</b></td> <td><b>Flashing LED</b></td> </tr> <tr> <td><b>Red</b></td> <td>BLOCKED/LATCHED</td> <td>LOCKOUT</td> </tr> <tr> <td><b>Green</b></td> <td>CLEAR</td> <td>BLANKING ON</td> </tr> <tr> <td><b>Yellow</b></td> <td>RESET</td> <td>Double Flash = Waiting for System Key Reset at Power-up Single Flash = ALIGNMENT. Flash rate increases with the number of sensing beams "made", solid yellow when aligned and defined area is clear</td> </tr> </table>		<b>Solid LED</b>	<b>Flashing LED</b>	<b>Red</b>	BLOCKED/LATCHED	LOCKOUT	<b>Green</b>	CLEAR	BLANKING ON	<b>Yellow</b>	RESET	Double Flash = Waiting for System Key Reset at Power-up Single Flash = ALIGNMENT. Flash rate increases with the number of sensing beams "made", solid yellow when aligned and defined area is clear
	<b>Solid LED</b>	<b>Flashing LED</b>											
<b>Red</b>	BLOCKED/LATCHED	LOCKOUT											
<b>Green</b>	CLEAR	BLANKING ON											
<b>Yellow</b>	RESET	Double Flash = Waiting for System Key Reset at Power-up Single Flash = ALIGNMENT. Flash rate increases with the number of sensing beams "made", solid yellow when aligned and defined area is clear											
<b>Diagnostic Indicator</b>	Two-digit numeric display indicates cause of lockout condition and total number of beams blocked.												
<b>Controls and Adjustments</b>	Keyed Reset of system lockout and latched conditions Floating Blanking selection switches and Fixed Blanking programming switches Auto Power-up On-Off switches												
<b>E-Stop Switch Input</b>	The Emergency Stop switch must offer two normally closed contacts and be capable of switching 50 mA @ 30V dc. Total resistance, including wiring and all switches, must not exceed 30 Ω for proper operation. Functional stop category 0 per NFPA 79 and EN 418, Safety Category 4 per EN 954-1. Simultaneity requirement less than 100 milliseconds.												
<b>External Device Monitoring (EDM) Input*</b>	Terminals must open within 200 milliseconds of the FSD outputs closing (i.e., a clear condition) and must close within 200 milliseconds of the FSD outputs opening (i.e., a blocked condition) or a lockout will occur. The monitoring contacts must be forced-guided (or captive contact) to maintain control reliability of the machine control circuit and must be capable of reliably switching 15 to 50V dc at 20 to 100 mA.												
<b>Test Input (except EDM models)</b>	Terminals must be closed for a minimum of 0.05 seconds in order to guarantee a test input signal. The switching device used must be capable of switching 15-50V dc at 20 to 100 mA.												
<b>AUX Non-Safety Output Contact</b>	Reed relay; 125V ac or dc max., 500 mA max. (10 VA max., resistive load)												

\* External Device Monitoring (EDM) models only.



## MICRO-SCREEN® DIN Module Controller Specifications (cont'd)

<b>Safety Outputs</b>	Forced-guided contact relays (resistive load). FSD1 & 2, SSD = 250V ac max., 4 amps max. <b>Mechanical life:</b> 10,000,000 operations (minimum). <b>Electrical life (at full rated load):</b> 100,000 operations (typical). <i>Arc suppression is recommended when switching inductive loads.</i> Note: Controllers with model suffix "2" have two FSD output contacts and those with model suffix "4" have four FSD output contacts.
<b>Enclosure</b>	<b>Material:</b> gray polycarbonate, clear polycarbonate cover <b>Rating:</b> NEMA 1; IP20
<b>Operating Conditions</b>	<b>Temperature:</b> 0° to +50° C <b>Relative humidity:</b> 95% maximum (non-condensing)
<b>FMEA Tested</b>	Per requirements IEC 61496-1
<b>Application Notes</b>	Use of fixed blanking requires sensors with 16 or more light beams. Up to 12 beams or 30% of the total number of beams in the array may be blanked, whichever is less. Call factory for applications assistance if a greater number of blanked beams is required.
<b>Certifications</b>	For a list of certifications see page 236.
<b>Wiring Diagrams</b>	<b>2 FSDs, 1 SSD and Power Monitoring:</b> WD019 (p. 256) <b>2 FSDs, 1 SSD and 1-Channel EDM:</b> WD020 (p. 256) <b>4 FSDs, 1 SSD and Power Monitoring:</b> WD021 (p. 257)

## MICRO-SCREEN® DIN Module with DeviceNet™ Specifications

<b>Device Net Power</b>	11 to 25V dc; 80 mA - supplied by DeviceNet BUS Network		
<b>Response Time</b>	<b>Light Screen:</b> Less than 38 milliseconds (all lengths) <b>E-Stop:</b> Less than 15 milliseconds		
<b>Status Indicators (on control module and receiver)</b>	<b>Solid LED</b>	<b>Flashing LED</b>	
	<b>Red</b>	BLOCKED/LATCHED	LOCKOUT
	<b>Green</b>	CLEAR	BLANKING ON
	<b>Yellow</b>	RESET	Double Flash = Waiting for System Key Reset at Power-up Single Flash = ALIGNMENT. Flash rate increases with the number of sensing beams "made", solid yellow when aligned and defined area is clear
	<b>Network status indicator:</b> A bi-color (red/green) LED visible on the control module indicates network status:		
	<b>Green</b>	Steady	On-line, connected to master
		Flashing	On-line, not connected/allocated to master; if Autobaud is ON, address and baud rate OK
	<b>Red</b>	Steady	Critical network fault or duplicate mode address detected
		Flashing	Connection time-out or no power to light screen
		OFF	No network power or off-line
	<b>Green/Red/OFF</b>		Autobaud detecting network baud rate
<b>Diagnostic Indicator</b>	Two-digit numeric display indicates cause of lockout condition and total number of beams blocked.		
<b>Controls and Adjustments</b>	Keyed RESET of system lockout and latched conditions Floating blanking selection switches and fixed blanking programming switches Auto Power-up On-Off switches		
<b>E-Stop Switch Input</b>	The Emergency Stop switch must offer two normally closed contacts and be capable of switching 50 mA @ 30V dc. Total resistance, including wiring and all switches, must not exceed 30 Ω for proper operation. Functional stop category 0 per NFPA 79 and EN 418, Safety Category 4 per EN 954-1. Simultaneity requirement less than 100 milliseconds.		
<b>Test Input</b>	Terminals must be closed for a minimum of 0.05 seconds in order to guarantee a test input signal. The switching device used must be capable of switching 15-50V dc at 20 to 100 mA.		

DeviceNet™ is a trademark of Rockwell Automation.

## MICRO-SCREEN® DIN Module with DeviceNet™ Specifications (cont'd)

DeviceNet™ Configuration	Vendor Code	12	(Banner Engineering Corp.)
	Device Type	130	(Safety Light Screen)
	Product Code		
	USDINT-1T2D/USDINT-1T4D	1	
	USDINT-2T2D/USDINT-2T4D	2	
	USDINT-1L2D/USDINT-1L4D	3	
	USDINT-2L2D/USDINT-2L4D	4	
	Connection Types Supported		Explicit Message, Poll, Change of State
	Network Address		0-63 (Manual Switches or Network configured)
	Baud Rate Supported		Autobaud or Network configured (125K, 250K, 500K) (Factory setting is Autobaud ON)
EDS File Names			
USDINT-1T2D/USDINT-1T4D		130_1_2.eds	
USDINT-2T2D/USDINT-2T4D		130_2_2.eds	
USDINT-1L2D/USDINT-1L4D		130_3_1.eds	
USDINT-2L2D/USDINT-2L4D		130_4_1.eds	
Bit Map Icon File Name		130.bmp	
	EDS and Bitmap files on 3.5" floppy disk supplied with controller (p/n 52243)		
Poll and COS I/O Assembly Instances	<p>The MICRO-SCREEN device I/O assemblies consist of:</p> <ul style="list-style-type: none"> <li>• <b>Poll:</b> One product specific input assembly containing operating mode, status of defined area, status of output relays, status of inputs (Key Reset, Test, and E-Stop), noise detected, number of sensor beams, number of beams blocked, Auto Power-up switch settings, COS trigger setting, autobaud setting, floating blanking switch settings and number of fixed beams (Fixed Blanking models only).</li> <li>• <b>COS:</b> One product-specific input assembly containing the operating mode and defined area status.</li> </ul>		
Auxiliary Monitor Relay	Reed relay; 125V ac or dc max., 500 mA max. (10 VA max., resistive load)		
Safety Outputs	<p>Forced-guided contact relays (resistive load). FSD1 &amp; 2, SSD = 250V ac max., 4 amps max. <b>Mechanical life:</b> 10,000,000 operations (minimum). <b>Electrical life (at full rated load):</b> 100,000 operations (typical). <i>Arc suppression is recommended when switching inductive loads.</i> Note: Controllers with model suffix "2" have two FSD output contacts and those with model suffix "4" have four FSD output contacts.</p>		
Enclosure	<p><b>Material:</b> gray polycarbonate, clear polycarbonate cover <b>Rating:</b> NEMA 1; IP20</p>		
Operating Conditions	<b>Temperature:</b> 0° to +50° C	<b>Relative humidity:</b> 95% maximum (non-condensing)	
FMEA Tested	Per requirements IEC 61496-1		
Application Notes	Use of fixed blanking requires sensors with 16 or more light beams. Up to 12 beams or 30% of the total number of beams in the array may be blanked, whichever is less. Call factory for applications assistance if a greater number of blanked beams is required.		
Certifications	For a list of certifications see page 236.		
Wiring Diagrams	<p><b>2 FSDs, 1 SSD and Power Monitoring:</b> WD019 (p. 256) <b>2 FSDs, 1 SSD and 1-Channel EDM:</b> WD020 (p. 256) <b>4 FSDs, 1 SSD and Power Monitoring:</b> WD021 (p. 257)</p>		

DeviceNet™ is a trademark of Rockwell Automation.

# MINI-SCREEN®

## Safety Light Screen Systems

- Family is designed for heavy-duty production machinery.
- Full system includes emitter, receiver, controller and interconnecting cables. Order QD cables separately.
- Standard or heavy-duty housing are available for emitters and receivers.
- Emitters and receivers feature compact housing with 19, 25 and 38 mm resolution.
- Explosion-proof enclosures are available.
- Systems include floating blanking (one- or two- beam), selectable auto power-up and optional fixed blanking.



*MINI-SCREEN 19 mm Emitters & Receivers . . . . .*Page 59  
*MINI-SCREEN 25 mm Emitters & Receivers . . . . .* 61  
*MINI-SCREEN 38 mm Heavy-Duty Emitters & Receivers. . . . .* 63  
*MINI-SCREEN Metal Box Controllers . . . . .* 64  
*MINI-SCREEN DIN Module Controllers. . . . .* 65  
*MINI-SCREEN Interfacing Products . . . . .* 66



### MINI-SCREEN® Emitters & Receivers

- 19 mm resolution with maximum 9 m range or 25 mm resolution with maximum 18 m range
- Yellow painted or black anodized aluminum housing with rugged end caps
- Twelve heights from 114 to 1219 mm
- Status indicators
- Swivel brackets for easy alignment
- 5-pin Mini QD connection standard
- QDS-... 5-pin Mini QD cables with "twisted pair" (see page 179)
- NEMA 4, 13; IEC IP65 housing

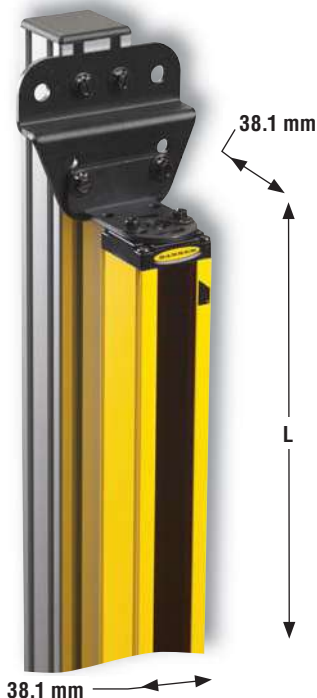

Full View of Available Finishes

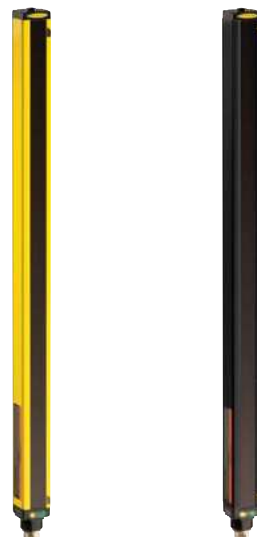



Yellow Painted Aluminum

Black Anodized Aluminum



# MINI-SCREEN®, Emitters & Receivers - 19 mm Resolution

Model Number	Housing	Defined Area	Housing Length (L)	Range	Connection*	Data Sheet
MSE424Y MSR424Y	 19 mm Resolution	114 mm	153 mm	9 m	5-Pin Mini QD	39022
MSE424 MSR424	 19 mm Resolution					
MSE824Y MSR824Y	 19 mm Resolution	215 mm	254 mm			
MSE824 MSR824	 19 mm Resolution					
MSE1224Y MSR1224Y	 19 mm Resolution	305 mm	356 mm			
MSE1224 MSR1224	 19 mm Resolution					
MSE1624Y MSR1624Y	 19 mm Resolution	406 mm	457 mm			
MSE1624 MSR1624	 19 mm Resolution					
MSE2024Y MSR2024Y	 19 mm Resolution	508 mm	558 mm			
MSE2024 MSR2024	 19 mm Resolution					
MSE2424Y MSR2424Y	 19 mm Resolution	610 mm	659 mm			
MSE2424 MSR2424	 19 mm Resolution					



19 mm Resolution Yellow Housing



19 mm Resolution Black Housing

\* For a 305 mm 5-Pin Mini Pigtail QD, add P to model number (example, **MSE424YP**). A model with a QD requires a mating cable (see page 179).  
Note: Emitters (example, **MSE424Y**) and receivers (example, **MSR424Y**) are sold separately.

# SAFETY LIGHT SCREENS

## MINI-SCREEN® Systems

### MINI-SCREEN®, Emitters & Receivers - 19 mm Resolution (cont'd)



SAFETY LIGHT SCREENS











EZ-SCREEN®

PICO-GUARD®

MICRO-SCREEN®

MINI-SCREEN®

EZ-SCREEN  
TYPE 2

Model Number	Housing	Defined Area	Housing Length (L)	Range	Connection*	Data Sheet
MSE2824Y MSR2824Y	 19 mm Resolution	711 mm	761 mm	9 m	5-Pin Mini QD	39022
MSE2824 MSR2824	 19 mm Resolution					
MSE3224Y MSR3224Y	 19 mm Resolution	813 mm	862 mm			
MSE3224 MSR3224	 19 mm Resolution					
MSE3624Y MSR3624Y	 19 mm Resolution	914 mm	963 mm			
MSE3624 MSR3624	 19 mm Resolution					
MSE4024Y MSR4024Y	 19 mm Resolution	1016 mm	1064 mm			
MSE4024 MSR4024	 19 mm Resolution					
MSE4424Y MSR4424Y	 19 mm Resolution	1118 mm	1166 mm			
MSE4424 MSR4424	 19 mm Resolution					
MSE4824Y MSR4824Y	 19 mm Resolution	1219 mm	1267 mm			
MSE4824 MSR4824	 19 mm Resolution					



19 mm Resolution Yellow Housing



19 mm Resolution Black Housing



\* For a 305 mm 5-Pin Mini Pigtail QD, add P to model number (example, **MSE2824YP**). A model with a QD requires a mating cable (see page 179).  
Note: Emitters (example, **MSE2824Y**) and receivers (example, **MSR2824Y**) are sold separately.





# MINI-SCREEN®, Emitters & Receivers - 25 mm Resolution

Model Number	Housing	Defined Area	Housing Length (L)	Range	Connection*	Data Sheet
MSXLE424Y MSXLR424Y	 25 mm Resolution	114 mm	153 mm	18 m	5-Pin Mini QD	39022
MSXLE424 MSXLR424	 25 mm Resolution					
MSXLE824Y MSXLR824Y	 25 mm Resolution	215 mm	254 mm			
MSXLE824 MSXLR824	 25 mm Resolution					
MSXLE1224Y MSXLR1224Y	 25 mm Resolution	305 mm	356 mm			
MSXLE1224 MSXLR1224	 25 mm Resolution					
MSXLE1624Y MSXLR1624Y	 25 mm Resolution	406 mm	457 mm			
MSXLE1624 MSXLR1624	 25 mm Resolution					
MSXLE2024Y MSXLR2024Y	 25 mm Resolution	508 mm	558 mm			
MSXLE2024 MSXLR2024	 25 mm Resolution					
MSXLE2424Y MSXLR2424Y	 25 mm Resolution	610 mm	659 mm			
MSXLE2424 MSXLR2424	 25 mm Resolution					

 25 mm Resolution Yellow Housing     25 mm Resolution Black Housing

\* For a 305 mm 5-Pin Mini Pigtail QD, add P to model number (example, **MSXLE424YP**). A model with a QD requires a mating cable (see page 179).  
Note: Emitters (example, **MSXLE424Y**) and receivers (example, **MSXLR424Y**) are sold separately.

# SAFETY LIGHT SCREENS

## MINI-SCREEN® Systems

### MINI-SCREEN®, Emitters & Receivers - 25 mm Resolution (cont'd)



SAFETY LIGHT SCREENS













EZ-SCREEN®

PICO-GUARD®

MICRO-SCREEN®

MINI-SCREEN®

EZ-SCREEN  
TYPE 2

Model Number	Housing	Defined Area	Housing Length (L)	Range	Connection*	Data Sheet
MSXLE2824Y MSXLR2824Y	 25 mm Resolution	711 mm	761 mm	18 m	5-Pin Mini QD	39022
MSXLE2824 MSXLR2824	 25 mm Resolution					
MSXLE3224Y MSXLR3224Y	 25 mm Resolution	813 mm	862 mm			
MSXLE3224 MSXLR3224	 25 mm Resolution					
MSXLE3624Y MSXLR3624Y	 25 mm Resolution	914 mm	963 mm			
MSXLE3624 MSXLR3624	 25 mm Resolution					
MSXLE4024Y MSXLR4024Y	 25 mm Resolution	1016 mm	1064 mm			
MSXLE4024 MSXLR4024	 25 mm Resolution					
MSXLE4424Y MSXLR4424Y	 25 mm Resolution	1118 mm	1166 mm			
MSXLE4424 MSXLR4424	 25 mm Resolution					
MSXLE4824Y MSXLR4824Y	 25 mm Resolution	1219 mm	1267 mm			
MSXLE4824 MSXLR4824	 25 mm Resolution					



25 mm Resolution Yellow Housing



25 mm Resolution Black Housing

\* For a 305 mm 5-Pin Mini Pigtail QD, add P to model number (example, **MSXLE2824YP**). A model with a QD requires a mating cable (see page 179).  
Note: Emitters (example, **MSXLE2824Y**) and receivers (example, **MSXLR2824Y**) are sold separately.

## MINI-SCREEN® Heavy-Duty Emitters & Receivers

- Robust, impact-resistant housing
- 38 mm resolution with 18 m range
- Seven heights from 610 to 1829 mm
- High immunity to ambient light interference
- Status indicators
- Swivel bracket for easy alignment
- 5-pin Mini QD connection standard
- QDS-... 5-pin Mini QD with "twisted pair" (see page 179)
- NEMA 4, 13; IEC IP65 housing

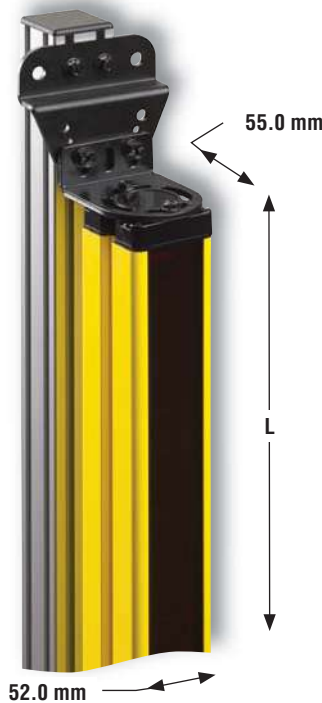

**Full View**



**MINI-SCREEN Heavy-Duty Emitters & Receivers**

**Yellow Painted Aluminum**

**SAFETY LIGHT SCREENS**

EZ-SCREEN®

PICO-GUARD®

MICRO-SCREEN®

**MINI-SCREEN®**

EZ-SCREEN®  
TYPE 2

## MINI-SCREEN® Heavy-Duty Emitters & Receivers - 38 mm Resolution



Model Number	Resolution	Defined Area	Housing Length (L)	Range	Connection*	Data Sheet
MSXLHDE2412Y MSXLHDR2412Y	 38 mm Resolution	610 mm	625 mm	18 m	5-Pin Mini QD	69018
MSXLHDE3212Y MSXLHDR3212Y		813 mm	826 mm			
MSXLHDE4012Y MSXLHDR4012Y		1016 mm	1029 mm			
MSXLHDE4812Y MSXLHDR4812Y		1219 mm	1229 mm			
MSXLHDE5612Y MSXLHDR5612Y		1422 mm	1433 mm			
MSXLHDE6412Y MSXLHDR6412Y		1626 mm	1633 mm			
MSXLHDE7212Y MSXLHDR7212Y		1829 mm	1836 mm			

38 mm Resolution

\* For a 305 mm 5-Pin Mini Pigtail QD, add P to model number (example, **MSXLHDE2412YP**). A model with a QD requires a mating cable (see page 179).  
Note: Emitters (example, **MSXLHDE2412Y**) and receivers (example, **MSXLHDR2412Y**) are sold separately.

# SAFETY LIGHT SCREENS

## MINI-SCREEN® Systems

SAFETY LIGHT SCREENS

EZ-SCREEN®

PICO-GUARD®

MICRO-SCREEN®

MINI-SCREEN®

EZ-SCREEN  
TYPE 2

### MINI-SCREEN® Metal Box Controllers

- Welded steel box with polyester powder paint finish
- 115/230V ac or 24V dc supply voltage
- Floating blanking and selectable auto power-up
- Optional fixed blanking, muting and External Device Monitoring (EDM)
- Latch or trip output
- NEMA 13, IEC IP64 housing



**MINI-SCREEN Metal Box Controller (MSCA-1 shown)**

**MINI-SCREEN Metal Box Controller with Muting (MSCC-2T2M shown)**

### MINI-SCREEN® Series, Metal Box Controllers



Models	Supply Voltage	Output Type	Safety Outputs*	Output Rating	Aux. Outputs**	Floating Blanking	Fixed Blanking	Data Sheet	
MSCT-1	24V dc	Trip	2 NO	4 amps	—	2-beam	No	39022	
MSCT-1T3				6 amps	1 NC			59664 & 39022	
MSCT-2				4 amps	—	1- or 2-beam	Yes	47295	
MSCT-2T3	6 amps	1 NC		59664 & 47295					
MSCA-1	115V ac	Trip		4 amps	—	2-beam	No	39022	
MSCA-1T3				6 amps	1 NC			59664 & 39022	
MSCA-1L2		Latch		4 amps	—			55702	
MSCA-1L3				6 amps	1 NC			59664 & 55702	
MSCA-1L3E*				6 amps	1 NC			46904 & 55702	
MSCA-1S2E*		Trip/Latch Selectable		4 amps	—			39022	
MSCA-1S3E*				6 amps	1 NC			39022	
MSCB-1		230V ac		Trip	4 amps			—	39022
MSCB-1T3					6 amps			1 NC	59664 & 39022
MSCB-1L2	Latch			4 amps	—	55702			
MSCD-2	115/230V ac	Trip		4 amps	—	1- or 2-beam	Yes	47295	
MSCD-2T3			6 amps	1 NC	59644 & 47295				

NC = Normally Closed Relay, NO = Normally Open Relay  
 \* The suffix "E" adds external device monitoring input  
 \*\* All models contain one Reed Relay (see specifications page 73)



# MINI-SCREEN® Series, Metal Box Controllers with Muting

Models	Supply Voltage	Output Type	Safety Outputs	Output Rating	Aux. Outputs**	Floating Blanking	Fixed Blanking	Data Sheet	
	MSCC-2T2M	115/230V ac or 24V dc	Trip	2 NO	4 amps	—	1- or 2-beam	Yes	64723
	MSCC-2T3M				6 amps	1 NC			
MSCC-2L2M	115/230V ac or 24V dc	Latch	4 amps		—				
MSCC-2L3M			6 amps		1 NC	61409			

NC = Normally Closed Relay, NO = Normally Open Relay  
 \* All models contain two Reed Relays (see specifications pages 74-75)  
 Note: External Device Monitoring (EDM) standard on all controllers with muting.

## MINI-SCREEN® DIN Module Controllers



- Polycarbonate housing with removable terminal blocks and clear cover
- 24V dc supply voltage
- Floating blanking and selectable auto power-up
- Latch or trip output
- Dual models for two emitter/receiver pairs
- NEMA 1; IP20 housing



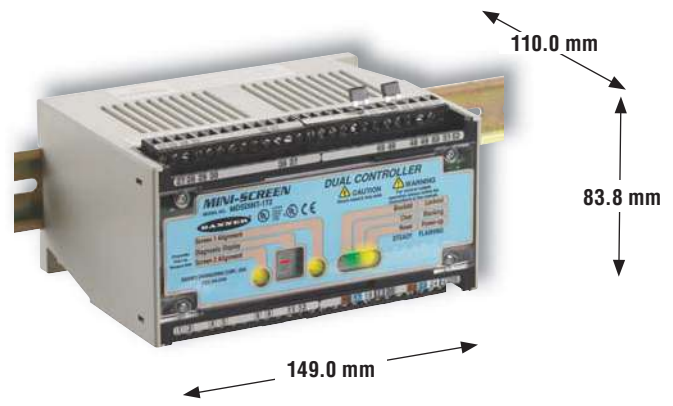

**MINI-SCREEN DIN Module Controller (MSDINT-1 shown)**



**MINI-SCREEN Dual DIN Module Controller (MDSINT-1T2 shown)**

## MINI-SCREEN Series, DIN Module Controllers



Models	Supply Voltage	Output Type	Safety Outputs*	Output Rating	Floating Blanking	Fixed Blanking	E-Stop Input	Light Screen Pairs/Controller	Data Sheet
	24V dc	Trip	2 NO	4 amps	2-beam	No	No	1 Pair	44895
		Latch							
		Trip			1- or 2-beam	Yes	2 Pairs	47297 & 60159	
		Latch							

NC = Normally Closed Relay, NO = Normally Open Relay  
 \* In addition to safety outputs, all models contain either one or two non-safety Reed Relay auxiliary outputs (see specifications pages 76-77).



# MINI-SCREEN® Interfacing Products

		Models	Description	Product Information	Data Sheet
<b>Muting Modules</b>		MM-TA-12B	<ul style="list-style-type: none"> <li>The Muting Module temporarily inhibits a safety light screen so materials can safely pass through the screen without stopping the machinery.</li> <li>The module uses redundant microcontroller-based logic.</li> </ul>	Page 123	63517
		MMD-TA-12B			
		MMD-TA-11B			
<b>Contactors</b>		<b>Mechanically Linked Contactors</b>	<ul style="list-style-type: none"> <li>Pairs of contactors create safety stop circuits with two normally open contacts in series.</li> <li>MINI-SCREEN can monitor the circuit because of the contactors' force-guided mechanically linked design.</li> <li>Contactors add 10 or 16 amp current carrying capability to any safety system.</li> <li>Auxiliary contacts add 3 or 4 normally open contacts.</li> <li>Suppressors extend the life of an actuating device that uses a contactor.</li> <li>Modular design simplifies assembly and installation.</li> </ul>	Page 186	111881
		11-BG00-31-A12060			
		11-BG00-31-D-024			
		11-BF1601-12060			
		11-BF16C01-024			
		<b>Aux. Contacts</b>			
		11-BGX10-40			
		11-G484-30			
		<b>Suppressors</b>			
		11-BGX77-048			
		11-BGX77-240			
		11-G318-48			
		11-G477-240			



# MINI-SCREEN® Metal Box Controller Kits - Floating Blanking



You can purchase a kit that contains an emitter and receiver of equal length and range; standard mounting brackets; and a pair of quick-disconnect cables. Detailed information about individual kit components is as follows.

- Metal Box Controllers – Floating Blanking ..... Page 64
- Emitter and Receivers ..... 59-63
- Cables ..... 179
- Brackets ..... 190

A **partial listing** of kits is listed below; see Kit Model Key to order other variations.

Kit Model Number	Sensor Housing			Defined Area	Resolution	Beams Per Foot	Range	Supply Voltage	Output Type	Number of Outputs	QD Cabling	
	Yellow	Black	Heavy-Duty Yellow									
MSKT24243C2		•		610 mm	19 mm	24	9 m	24V dc	Trip	2 NO Safety Outputs & 1 NC Aux.	8 m, 2 each	
MSKT24243C2Y	•				25 mm		18 m					
MSXLKT24243C2		•				38 mm						12
MSXLKT24243C2Y	•				19 mm		24					
MSXLHDKT24123C2Y			•			25 mm		18 m				
MSKA24243C2		•			38 mm		12					18 m
MSKA24243C2Y	•					19 mm		24				
MSXLKA24243C2		•			25 mm		18 m					
MSXLKA24243C2Y	•					38 mm		12				18 m
MSXLHDKA24123C2Y			•		19 mm		24					
MSKB24243C2		•				25 mm		18 m				
MSKB24243C2Y	•				38 mm		12					18 m
MSXLKB24243C2		•		19 mm		24		9 m				
MSXLKB24243C2Y	•				25 mm		18 m					
MSXLHDKB24123C2Y			•									

NC = Normally Closed Relay, NO = Normally Open Relay

## Kit Model Key

Model Style	Emitter/Receiver Separation	Kit	Supply Voltage	Options	Defined Area	Beams Per Foot	Output Type	Output Configuration	QD Cables	Finish	Sensor Cable Termination
<b>M S</b>	<b>X L</b>	<b>K</b>	<b>A</b>		<b>2 4</b>	<b>2 4</b>		<b>3</b>	<b>C 2</b>	<b>Y</b>	<b>P</b>

**Model Style**  
MS = MINI-SCREEN

**Emitter/Receiver Separation**  
Blank = 9 m  
XL = 18 m  
XLHD = Heavy-Duty 18 m

**Kit**  
K = Kit

**Supply Voltage**  
A = 115V ac  
B = 230V ac  
T = 24V dc

**Options**  
E = With External Device Monitoring (EDM)  
Blank = Without

**Defined Area**  
4 = 114 mm  
8 = 215 mm  
12 = 305 mm  
16 = 406 mm  
20 = 508 mm  
24 = 610 mm  
28 = 711 mm  
32 = 813 mm  
36 = 914 mm  
40 = 1016 mm  
44 = 1118 mm  
48 = 1219 mm

**Beams per Foot**  
24 = Standard & Long-Range Series  
12 = Heavy-Duty Series

**Output Configuration**  
Blank = 2 NO Safety Outputs  
3 = 2 NO Safety Outputs & 1 NC Aux.

**Output Type**  
Blank = Trip  
L = Latch  
S = Trip/Latch Selectable

**Sensor Cable Termination**  
Blank = Integral QD connector  
P = Pigtail QD

**Sensor Finish**  
Blank = Black anodized  
Y = Yellow polyester paint

**Quick-Disconnect Cables**  
C1 = 2 x 5 m  
C2 = 2 x 8 m  
C3 = 1 x 5 m plus 1 x 8 m

NOTE: Not all combinations are possible. Contact Banner Engineering Corp. for additional information and/or verification of valid kit model number.

# MINI-SCREEN® Metal Box Kits - Floating & Fixed Blanking



You can purchase a kit that contains an emitter and receiver of equal length and range; standard mounting brackets; and a pair of quick-disconnect cables. Detailed information about individual kit components is as follows.

- Metal Box Controllers – Floating & Fixed Blanking . . . . .Page 64
- Emitter and Receivers . . . . . 59-63
- Cables . . . . . 179
- Brackets. . . . . 190

A **partial listing** of kits is listed below; see Kit Model Key to order other variations.

Kit Model Number	Sensor Housing			Defined Area	Resolution	Beams Per Foot	Range	Supply Voltage	Output Type	Number of Outputs	QD Cabling
	Yellow	Black	Heavy-Duty Yellow								
MSK2T24243C2		•		610 mm	19 mm	24	9 m	24V dc	Trip	2 NO Safety Outputs & 1 NC Aux.	8 m, 2 each
MSK2T24243C2Y	•				25 mm		18 m				
MSXLK2T24243C2		•				38 mm	18 m				
MSXLK2T24243C2Y	•				19 mm		12				
MSXLHDK2T24123C2Y			•			25 mm		24			
MSK2D24243C2		•					38 mm				
MSK2D24243C2Y	•					19 mm		24			
MSXLK2D24243C2		•					25 mm				
MSXLK2D24243C2Y	•					38 mm		12			
MSXLHDK2D24123C2Y			•								

NC = Normally Closed Relay, NO = Normally Open Relay

## Kit Model Key

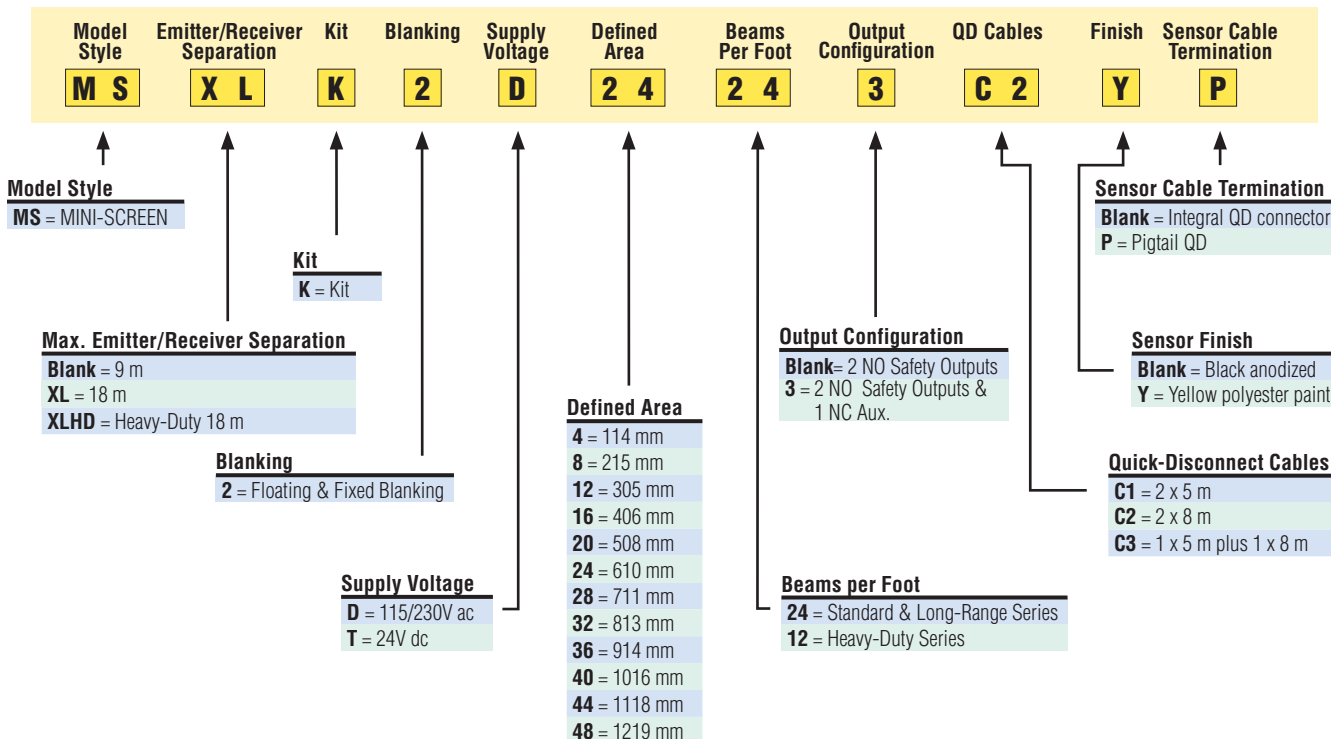

NOTE: Not all combinations are possible. Contact Banner Engineering Corp. for additional information and/or verification of valid kit model number.

# MINI-SCREEN® Metal Box with Muting Kits - Floating & Fixed Blanking



You can purchase a kit that contains an emitter and receiver of equal length and range; standard mounting brackets; and a pair of quick-disconnect cables. Detailed information about individual kit components is as follows.

- Metal Box Controllers with Muting – Floating & Floating Blanking . . . . .Page 65
- Emitter and Receivers . . . . . 59-63
- Cables . . . . . 179
- Brackets. . . . . 190

A **partial listing** of kits is listed below; see Kit Model Key to order other variations.

Kit Model Number	Sensor Housing			Defined Area	Resolution	Beams Per Foot	Range	Supply Voltage	Output Type	Number of Outputs	QD Cabling
	Yellow	Black	Heavy-Duty Yellow								
MSK2CM24243C2		•		610 mm	19 mm	24	9 m	115/230V ac or 24V dc	Trip	2 NO Safety Outputs & 1 NC Aux.	8 m, 2 each
MSK2CM24243C2Y	•				25 mm		18 m				
MSXLK2CM24243C2		•			38 mm	12	18 m				
MSXLK2CM24243C2Y	•										
MSXLHDK2CM24123C2Y			•								

NC = Normally Closed Relay, NO = Normally Open Relay

## Kit Model Key

Model Style	Emitter/Receiver Separation	Kit	Blanking	Supply Voltage	Muting	Defined Area	Beams Per Foot	Output Type	No. of Outputs	QD Cables	Finish	Sensor Cable Termination
<b>MS</b>	<b>XL</b>	<b>K</b>	<b>2</b>	<b>C</b>	<b>M</b>	<b>24</b>	<b>24</b>			<b>C2</b>	<b>Y</b>	<b>P</b>

**Model Style**  
MS = MINI-SCREEN

**Kit**  
K = Kit

**Blanking**  
2 = Floating & Fixed Blanking

**Supply Voltage**  
C = 115/230V ac or 24V dc

**Muting Function**  
M = Muting

**Defined Area**  
4 = 114 mm  
8 = 215 mm  
12 = 305 mm  
16 = 406 mm  
20 = 508 mm  
24 = 610 mm  
28 = 711 mm  
32 = 813 mm  
36 = 914 mm  
40 = 1016 mm  
44 = 1118 mm  
48 = 1219 mm

**Beams per Foot**  
24 = Standard & Long-Range Series  
12 = Heavy-Duty Series

**Output Type**  
Blank = Trip  
L = Latch

**Number of Outputs**  
Blank = 2 NO Safety Outputs  
3 = 2 NO Safety Outputs & 1 NC Aux.

**QD Cables**  
C1 = 2 x 5 m  
C2 = 2 x 8 m  
C3 = 1 x 5 m plus 1 x 8 m

**Sensor Finish**  
Blank = Black anodized  
Y = Yellow polyester paint

**Sensor Cable Termination**  
Blank = Integral QD connector  
P = Pigtail QD

NOTE: Not all combinations are possible. Contact Banner Engineering Corp. for additional information and/or verification of valid kit model number.

## MINI-SCREEN® DIN Module Controller Kits - Floating Blanking



You can purchase a kit that contains an emitter and receiver of equal length and range; standard mounting brackets; and a pair of quick-disconnect cables. Detailed information about individual kit components is as follows.

- DIN Module Controllers – Floating Blanking. . . . . Page 65
- Emitter and Receivers . . . . . 59-63
- Cables . . . . . 179
- Brackets . . . . . 190

A **partial listing** of kits is listed below; see Kit Model Key to order other variations.

Kit Model Number	Sensor Housing			Defined Area	Resolution	Beams Per Foot	Range	Supply Voltage	Output Type	Number of Outputs	QD Cabling
	Yellow	Black	Heavy-Duty Yellow								
MSDKT2424C2		•		610 mm	19 mm	24	9 m	24V dc	Trip	2 NO Safety Outputs	8 m, 2 each
MSDKT2424C2Y	•				25 mm		18 m				
MSXLDKT2424C2		•			38 mm	12	18 m				
MSXLDKT2424C2Y	•										
MSXLHDKT2412C2Y			•								

NC = Normally Closed Relay, NO = Normally Open Relay

### Kit Model Key

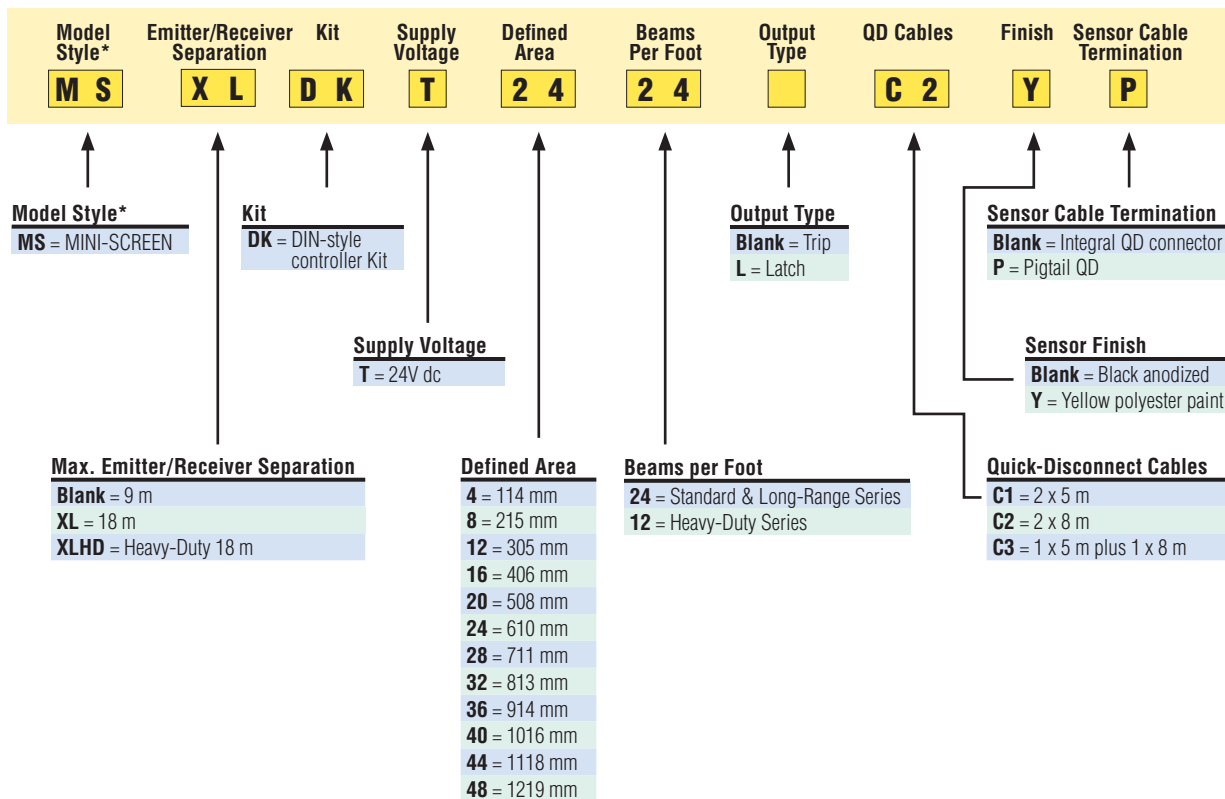

\* Kits are not available for Dual DIN Modules. A controller, two emitter/receiver pairs and the appropriate cables are sold separately (see page 179).  
NOTE: Not all combinations are possible. Contact Banner Engineering Corp. for additional information and/or verification of valid kit model number.

## MINI-SCREEN® Emitter & Receiver Specifications

<b>Emitter/Receiver Separation</b>	<b>19 mm Resolution Emitters and Receivers:</b> 150 mm to 9 m <b>25.4 mm Resolution Emitters and Receivers:</b> 150 mm to 18 m	
<b>Minimum Object Sensitivity</b>	<b>19 mm Resolution:</b> 19.1 mm floating blanking OFF 31.8 mm 1-beam floating blanking ON 44.5 mm 2-beam floating blanking ON	<b>25.4 mm Resolution:</b> 25.4 mm floating blanking OFF 38.1 mm 1-beam floating blanking ON 50.8 mm 2-beam floating blanking ON
<b>Response Time</b>	Less than 48 milliseconds using emitter/receiver with 114 to 406 mm defined area Less than 60 milliseconds using emitter/receiver with 508 to 813 mm defined area Less than 72 milliseconds using emitter/receiver with 914 to 1219 mm defined area	
<b>Self-Checking Interval</b>	20 milliseconds	
<b>Ambient Light Immunity</b>	>10,000 lux at 5° angle of incidence	
<b>Strobe Light Immunity</b>	Totally immune to one Federal Signal Corp. "Fireball" model FB2PST strobe.	
<b>Emitter Elements</b>	Infrared LEDs; 880 nm peak emission	
<b>Status Indicators</b>	<b>Emitter:</b> Green LED for power ON <b>Receiver:</b> Red, yellow and green status indicators with the same functions as those on the left side of the control box (see individual Control Box Specifications, pages 73-77). Yellow also indicates alignment. Indicators are visible on three sides of receiver or emitter base.	
<b>Emitter and Receiver Enclosures</b>	<b>Materials:</b> Aluminum extrusion with black anodized or yellow polyester painted finish; acrylic lens cover Mounting hardware supplied <b>Rating:</b> NEMA 4, 13; IEC IP65	
<b>Mounting Hardware</b>	Emitter and receiver are each supplied with a pair of mounting brackets. Mounting brackets are 11-gauge cold-rolled black zinc chromate finished steel. A set of four vibration dampening mounts is also supplied.	
<b>Cables</b>	<b>Emitters and Receivers with Pigtail (MSE/MSRxxxxYP) Quick Disconnect:</b> Pigtail QD connectors have a 305 mm long cable, terminated with a 5-pin Mini-style quick-disconnect fitting. Mating interconnect cables are ordered separately (unless a MINI-SCREEN kit is ordered, see Models and Accessories, page 179), and are available in lengths of 4.5 m, 7.6 m, 15 m, 30 m and 45 m.  NOTE: Contact factory when cable length exceeding 53 m is required. Use only Banner cables, which incorporate a shielded "twisted pair" for noise immunity on RS485 data communications lines. Use of other cables may result in "nuisance" trips or lockouts.	
<b>Optical Performance</b>	This system meets $\pm 2.5^\circ$ requirements of IEC 61496-2, section 5.2.9 (Type 4)	
<b>Operating Conditions</b>	<b>Temperature:</b> 0° to +50° C	<b>Relative humidity:</b> 95% maximum (non-condensing)
<b>Certifications</b>	For a list of certifications see page 236.	

## MINI-SCREEN® Heavy-Duty Emitter & Receiver Specifications

<b>Emitter/Receiver Separation</b>	150 mm to 18 m
<b>Minimum Object Sensitivity</b>	38 mm floating blanking OFF 62 mm 1-beam floating blanking ON 89 mm 2-beam floating blanking ON
<b>Response Time</b>	Less than 48 milliseconds for 610 mm and 813 mm emitter/receiver Less than 60 milliseconds for 1016 mm to 1626 mm emitter/receiver Less than 72 milliseconds for 1829 mm emitter/receiver
<b>Self-Checking Interval</b>	20 milliseconds
<b>Ambient Light Immunity</b>	>10,000 lux at 5° angle of incidence
<b>Strobe Light Immunity</b>	Totally immune to one Federal Signal Corp. "Fireball" model FB2PST strobe.
<b>Emitter Elements</b>	Infrared LEDs; 880 nm peak emission
<b>Status Indicators</b>	<b>Emitter:</b> Green LED for power ON <b>Receiver:</b> Red, yellow and green status indicators with the same functions as those on the left side of the control box (see individual Control Box Specifications, pages 73-77). Yellow also indicates alignment. Indicators are visible on three sides of receiver or emitter base.
<b>Emitter and Receiver Enclosures</b>	<b>Materials:</b> Aluminum extrusion with yellow polyester painted finish; acrylic lens cover. Mounting hardware supplied. <b>Rating:</b> NEMA 4, 13; IEC IP65
<b>Mounting Hardware</b>	Emitter and receiver are each supplied with a pair of mounting brackets. Mounting brackets are 8-gauge cold-rolled black zinc chromate finished steel.
<b>Cables</b>	<b>Emitters and Receivers with Pigtail (MSXLHDE/MSXLHDRxxxxYP) Quick Disconnect:</b> Pigtail QD connectors have a 305 mm long cable, terminated with a 5-pin Mini-style quick-disconnect fitting. Mating interconnect cables are ordered separately (unless a MINI-SCREEN kit is ordered, see Models and Accessories, page 179), and are available in lengths of 4.5 m, 7.6 m, 15 m, 30 m and 45 m.  NOTE: Contact factory when cable length exceeding 53 m is required. Use only Banner cables, which incorporate a shielded "twisted pair" for noise immunity on RS485 data communications lines. Use of other cables may result in "nuisance" trips or lockouts.
<b>Optical Performance</b>	This system meets $\pm 2.5^\circ$ requirements of IEC 61496-2, section 5.2.9 (Type 4)
<b>Operating Conditions</b>	<b>Temperature:</b> 0° to +50° C <b>Relative humidity:</b> 95% maximum (non-condensing)
<b>Certifications</b>	For a list of certifications see page 236.



## MINI-SCREEN® Metal Box Controller Specifications

<b>System Power Requirements</b>	<b>MSCA-.. models:</b> 115V ac $\pm$ 15% (50/60 Hz), 55 VA <b>MSCB-.. models:</b> 230V ac $\pm$ 15% (50/60 Hz), 55 VA <b>MSCT-.. models:</b> 24V dc $\pm$ 15%, 10% max. ripple, 1.5 amps max. <b>MSCD-.. models:</b> 115/230V ac $\pm$ 15% (50/60 Hz), 55 VA	
<b>Fuse Rating</b>	<b>MSCA-1.. models:</b> ½ amp, 250V (3 AG or 5x20 mm slow blow) <b>MSCB-1.. models:</b> ¼ amp, 250V (3 AG or 5x20 mm slow blow) <b>MSCT-1.. models:</b> 2 amp, 250V (3 AG or 5x20 mm slow blow) <b>MSCD-2.. models:</b> 115V ac: 1 amp, 250V; 230V ac: 1/2 amp, 250V <b>MSCT-2.. models:</b> 2 amp, 250V (all fuses 3 AG or 5x20 mm slow blow)	
<b>Response Time</b>	<b>Standard and Long-Range Emitters/Receivers:</b> Less than 48 milliseconds using emitter/receiver with 114 mm to 406 mm defined area Less than 60 milliseconds using emitter/receiver with 508 mm to 813 mm defined area Less than 72 milliseconds using emitter/receiver with 914 mm to 1219 mm defined area  <b>Heavy-Duty Emitters/Receivers:</b> Less than 48 milliseconds using emitter/receiver with 610 mm to 813 mm defined area Less than 60 milliseconds using emitter/receiver with 1016 mm to 1626 mm defined area Less than 72 milliseconds using emitter/receiver with 1829 mm defined area	
<b>Status Indicators</b> (on control box and receiver)	<b>Red</b> <b>Green</b> <b>Yellow</b>	<b>Solid LED</b> BLOCKED/LATCHED CLEAR RESET  <b>Flashing LED</b> LOCKOUT BLANKING ON Double Flash = Waiting for Power-up Key Reset Single Flash = ALIGNMENT. Flash rate increases with the number of sensing beams "made", solid yellow when aligned and defined area is clear
<b>Diagnostic Indicators</b>	<b>MSCT-2.. &amp; MSCD-2..:</b> Two-digit numeric display indicates cause of lockout condition. Display is visible through a window in the control box cover.  <b>MSCA-1.., MSCB-1.. &amp; MSCT-1..:</b> Four LEDs indicate cause of lockout condition. Diagnostic LEDs are visible through a window in the control box cover.	
<b>Controls and Adjustments</b>	Keyed Reset of system lockout or latched conditions Floating Blanking selection switches and Fixed Blanking programming switches Auto Power Up On-Off switches	
<b>Test Input</b>	Terminals must be closed for a minimum of 0.05 seconds in order to guarantee a test input signal. The switching device used must be capable of switching 15-50V dc at 20 to 100 mA.	
<b>External Device Monitoring (EDM) Input</b>	Terminals must be closed before controller attempts to reset (close) the FSD outputs after clearing an interruption of the defined area. The EDM input should open when the FSD outputs close (a clear condition), but this is not required. The EDM input must be closed within 200 milliseconds of the FSD outputs opening (a blocked condition) or a lockout condition will occur. The contacts of the monitored device must be capable of switching 15-50V dc at 20 to 100 mA.	
<b>Auxiliary Monitor Relay</b>	Reed relay; 125V ac or dc max., 500 mA max. (10 VA max., resistive load)	
<b>Safety Outputs</b>	Forced-guided contact relay (resistive load). <b>MSC-...:2:</b> FSD1 & 2, SSD = 250V ac max., 4 amp max. <b>MSC-...:3:</b> FSD1 & 2, CNC = 250V ac max., 6 amp max.; SSD = 250V ac max., 4 amp max <b>Mechanical life:</b> 10,000,000 operations (minimum). <b>Electrical life:</b> 100,000 operations (typical @ 1.0 kVA switching power). <i>Arc suppression is recommended when switching inductive loads.</i>	
<b>Enclosure</b>	<b>Material:</b> Welded steel box with black polyester powder paint finish. <b>Rating:</b> NEMA 13, IEC IP64	
<b>Operating Conditions</b>	<b>Temperature:</b> 0° to +50° C	<b>Relative humidity:</b> 95% maximum (non-condensing)
<b>FMEA Tested</b>	Per requirements IEC 61496-1 (type 4)	
<b>Application Notes</b>	Use of fixed blanking requires sensors with 16 or more light beams. Up to 12 beams or 30% of the total number of beams in the array may be blanked, whichever is less. Call factory for applications assistance if a greater number of blanked beams is required.	
<b>Certifications</b>	For a list of certifications see page 236.	
<b>Wiring Diagrams</b>	<b>2 FSDs, 1 SSD and Power Monitoring:</b> WD022 (p. 258)	

## MINI-SCREEN® Metal Box Controller with Muting Specifications

<b>System Power Requirements</b>	115V ac (50/60Hz) ± 15% @ 500 mA (50 VA), 230V ac (50/60Hz) ± 15% @ 250 mA (50 VA), or 24V dc ±15%, 10% max. ripple, @ 2.5 A (60 W)																								
<b>Fuse Rating</b>	<b>115V ac:</b> 1.0 A @ 250V ac (supplied) <b>230V ac:</b> 500 mA @ 250V ac <b>+24V dc:</b> Internal resettable																								
<b>Response Time</b>	<b>Standard and Long-Range Emitters/Receivers:</b> Less than 58 milliseconds using emitter/receiver with 114 mm to 406 mm defined area Less than 70 milliseconds using emitter/receiver with 508 mm to 813 mm defined area Less than 82 milliseconds using emitter/receiver with 914 mm to 1219 mm defined area  <b>Heavy-Duty Emitters/Receivers:</b> Less than 58 milliseconds using emitter/receiver with 610 mm to 813 mm defined area Less than 70 milliseconds using emitter/receiver with 1016 mm to 1626 mm defined area Less than 82 milliseconds using emitter/receiver with 1829 mm defined area																								
<b>Status Indicators</b> (on control box and receiver)	<b>Standard models:</b> <b>Light Screen Indicators (left column of LEDs):</b> <table border="0"> <tr> <td></td> <td><b>Solid LED</b></td> <td><b>Flashing LED</b></td> </tr> <tr> <td><b>Red</b></td> <td>BLOCKED/LATCHED</td> <td>LOCKOUT</td> </tr> <tr> <td><b>Green</b></td> <td>CLEAR</td> <td>BLANKING ON</td> </tr> <tr> <td><b>Yellow</b></td> <td>RESET</td> <td>Double Flash = Waiting for Light Screen Key Reset at Power-up Single Flash = ALIGNMENT. Flash rate increases with the number of sensing beams "made", solid yellow when aligned and defined area clear</td> </tr> </table> <b>System Indicators (right column of LEDs):</b> <table border="0"> <tr> <td></td> <td><b>Solid LED</b></td> <td><b>Flashing LED</b></td> </tr> <tr> <td><b>Red</b></td> <td>OVERRIDE</td> <td>LOCKOUT</td> </tr> <tr> <td><b>Green</b></td> <td>OUTPUT ON (FSD1 &amp; FSD2 closed)</td> <td>(Not Applicable)</td> </tr> <tr> <td><b>Yellow</b></td> <td>RESET (System)</td> <td>Double Flash = Waiting for System Key Reset at Power-up Single Flash = Waiting for System Key Reset at latched condition (manual reset of system after blockage has been removed)</td> </tr> </table>		<b>Solid LED</b>	<b>Flashing LED</b>	<b>Red</b>	BLOCKED/LATCHED	LOCKOUT	<b>Green</b>	CLEAR	BLANKING ON	<b>Yellow</b>	RESET	Double Flash = Waiting for Light Screen Key Reset at Power-up Single Flash = ALIGNMENT. Flash rate increases with the number of sensing beams "made", solid yellow when aligned and defined area clear		<b>Solid LED</b>	<b>Flashing LED</b>	<b>Red</b>	OVERRIDE	LOCKOUT	<b>Green</b>	OUTPUT ON (FSD1 & FSD2 closed)	(Not Applicable)	<b>Yellow</b>	RESET (System)	Double Flash = Waiting for System Key Reset at Power-up Single Flash = Waiting for System Key Reset at latched condition (manual reset of system after blockage has been removed)
	<b>Solid LED</b>	<b>Flashing LED</b>																							
<b>Red</b>	BLOCKED/LATCHED	LOCKOUT																							
<b>Green</b>	CLEAR	BLANKING ON																							
<b>Yellow</b>	RESET	Double Flash = Waiting for Light Screen Key Reset at Power-up Single Flash = ALIGNMENT. Flash rate increases with the number of sensing beams "made", solid yellow when aligned and defined area clear																							
	<b>Solid LED</b>	<b>Flashing LED</b>																							
<b>Red</b>	OVERRIDE	LOCKOUT																							
<b>Green</b>	OUTPUT ON (FSD1 & FSD2 closed)	(Not Applicable)																							
<b>Yellow</b>	RESET (System)	Double Flash = Waiting for System Key Reset at Power-up Single Flash = Waiting for System Key Reset at latched condition (manual reset of system after blockage has been removed)																							
<b>Diagnostic Indicators</b>	<b>Light Screen Diagnostic Display (left window)</b> is a two-digit numeric display that indicates the cause of lockout conditions. <b>System Diagnostic Display (right window)</b> is a two-digit numeric display that indicates the cause of lockout conditions and the amount of time, in seconds, remaining for the backdoor timer.																								
<b>Controls and Adjustments</b>	<ul style="list-style-type: none"> <li>• Light Screen Key Reset after power-up and light screen lockouts</li> <li>• Selection switches to enable floating blanking</li> <li>• Program switches to enable fixed blanking</li> <li>• Light Screen and System Auto Power-up selection switches</li> <li>• System Key Reset after power-up, system lockouts, and latched conditions</li> <li>• Selection switches for Monitored or Non-Monitored Muting Indicator</li> <li>• Selection switches for One-Way or Two-Way (directional/non-directional) Muting</li> <li>• Selection switches for One-Channel, Two-Channel Monitoring or No Monitoring (EDM)</li> <li>• Selection switches for Backdoor Timer settings and Mute-on-Power-Up</li> </ul>																								
<b>Light Screen and System Reset Inputs</b>	Terminals must be closed for a minimum of 0.05 seconds in order to guarantee a reset. The switching device must be capable of switching 15-50V dc at 20-100 mA.																								
<b>External Device Monitoring (EDM) Input(s)</b>	Two pairs of terminals are provided to monitor the state of external devices that are being controlled by the FSD outputs. The device must be capable of switching 15-50V dc at 20-100 mA.																								
<b>Mute Enable Input</b>	Terminals must be closed in order to start a mute; opening this input after mute has begun has no effect. The switching device must be capable of switching 15-50V dc at 20-100 mA.																								
<b>Override Inputs</b>	The two-channel inputs must be closed within 3 seconds of each other (simultaneity requirement) and held closed during the 10-second Override. To initiate a subsequent Override, open both channels, wait 3 seconds, and then re-close both channels (within 3 seconds). The switching devices must be capable of switching 15-50V dc at 20-100 mA.																								
<b>Muting Device Input</b>	The muting devices work in pairs (M1 and M2, M3 and M4) and are required to be "closed" within 3 seconds of each other (simultaneity requirement) to initiate a mute (assuming all other conditions are met). Each muting device must be capable of switching 15-50V dc at 20-100 mA.																								
<b>Light Screen and System Aux. Monitor Relay Outputs</b>	Reed relay; 125V ac/dc max. at 500 mA max. (10 VA maximum, resistive load)																								

**MINI-SCREEN® Metal Controller Box with Muting Specifications (cont'd)**

<b>CNC Aux. Monitor Relay Outputs</b> (Model MSCC-2T3M/-2L3M)	Forced-guided contact relay, 250V ac at 6 amps max. (resistive load)
<b>Safety Outputs</b>	Forced-guided contact relay (resistive load). <b>MSCC-..2:</b> FSD1 & 2, SSD = 250V ac max., 4 amp max. <b>MSCC-..3:</b> FSD1 & 2, CNC = 250V ac max., 6 amp max.; SSD = 250V ac max., 4 amp max. <b>Mechanical life:</b> 10,000,000 operations (minimum). <b>Electrical life:</b> 100,000 operations (typical @ 1.0 kVA switching power). <i>Arc suppression is recommended when switching inductive loads.</i>
<b>Mute Lamp Output</b>	A monitored or non-monitored (selectable) sinking output. If monitoring has been selected, the current draw must be within 10 mA to 360 mA. <b>Max. switching voltage:</b> 30V dc <b>Max. switching current:</b> 360 mA <b>Min. switching current:</b> 10 mA <b>Saturation voltage:</b> ≤ 1.5V dc
<b>Auxiliary DC Supply Output</b>	24V dc ± 25%, 500 mA max
<b>Enclosure</b>	<b>Material:</b> Welded steel box with black polyester powder paint finish. <b>Rating:</b> NEMA 13; IEC IP64
<b>Operating Conditions</b>	<b>Temperature:</b> 0° to +50° C <b>Relative humidity:</b> 95% max. (non-condensing)
<b>FMEA Tested</b>	Per requirements IEC 61496-1 (Type 4)
<b>Application Notes</b>	Use of fixed blanking requires sensors with 16 or more light beams. Up to 12 beams or 30% of the total number of beams in the array may be blanked, whichever is less. Call factory for applications assistance if a greater number of blanked beams is required.
<b>Certifications</b>	For a list of certifications see page 236.
<b>Wiring Diagrams</b>	<b>2 FSDs, 1 SSD and 2-Channel EDM:</b> WD023 (p. 258)

## MINI-SCREEN® DIN Module Controller Specifications

<b>System Power Requirements</b>	24V dc $\pm$ 15%, 10% max. ripple, 1.5 amps. max.	
<b>Fuse Rating</b>	2 amp, 250V (3 AG or 5x20 mm slow blow)	
<b>Response Time</b>	<p><b>Standard Emitters/Receivers:</b>            Less than 48 milliseconds using emitter/receiver with 114 mm to 406 mm defined area            Less than 60 milliseconds using emitter/receiver with 508 mm to 813 mm defined area            Less than 72 milliseconds using emitter/receiver with 914 mm to 1219 mm defined area</p> <p><b>Heavy-Duty Emitters/Receivers:</b>            Less than 48 milliseconds using emitter/receiver with 610 mm to 813 mm defined area            Less than 60 milliseconds using emitter/receiver with 1016 mm to 1626 mm defined area            Less than 72 milliseconds using emitter/receiver with 1829 mm defined area</p>	
<b>Status Indicators</b> (on control box and receiver)	<p><b>Solid LED</b></p> <p><b>Red</b>      BLOCKED/LATCHED  <b>Green</b>     CLEAR  <b>Yellow</b>    RESET</p>	<p><b>Flashing LED</b></p> <p>LOCKOUT            BLANKING ON            Double Flash = Waiting for Power-up Key Reset            Single Flash = ALIGNMENT. Flash rate increases with the number of sensing beams "made", solid yellow when aligned and defined area is clear</p>
<b>Diagnostic Indicators</b>	Four LEDs indicate cause of lockout conditions. Diagnostic LEDs are visible through a window in the control module cover.	
<b>Controls and Adjustments</b>	Keyed Reset of system lockout and latched conditions Blanking selection switches Auto Power Up On-Off switches	
<b>Auxiliary Monitor or Alarm Relay</b>	Reed relay; 125V ac or dc max., 500 mA max. (10 VA max., resistive load)	
<b>Safety Outputs</b>	Forced-guided contact relays (resistive load) FSD1 & 2, SSD = 250V ac max., 4 amps max. <b>Mechanical life:</b> 10,000,000 operations (minimum) <b>Electrical life:</b> 100,000 operations (typical @ 1.0 kVA switching power) <i>Arc suppression is recommended when switching inductive loads.</i>	
<b>Enclosure</b>	<b>Material:</b> polycarbonate <b>Rating:</b> NEMA 1; IEC IP20	
<b>Operating Conditions</b>	<b>Temperature:</b> 0° to +50° C	<b>Relative humidity:</b> 95% maximum (non-condensing)
<b>FMEA Tested</b>	Per requirements of proposed first edition of IEC 61496-1 (Type 4)	
<b>Certifications</b>	For a list of certifications see page 236.	
<b>Wiring Diagrams</b>	<b>2 FSDs, 1 SSD and Power Monitoring:</b> WD024 (p. 259)	

## MINI-SCREEN® Dual DIN Module Controller Specifications

<b>System Power Requirements</b>	24V dc $\pm 15\%$ , 10% max. ripple, 2.5 amps max.												
<b>Fuse Rating</b>	2 amp, 250V (3 AG or 5x20 mm slow blow)												
<b>Response Time</b>	<p><b>Standard and Long-Range Emitters/Receivers:</b>            Less than 48 milliseconds using emitter/receiver with 114 mm to 406 mm defined area            Less than 60 milliseconds using emitter/receiver with 508 mm to 813 mm defined area            Less than 72 milliseconds using emitter/receiver with 914 mm to 1219 mm defined area</p> <p><b>Heavy-Duty Emitters/Receivers:</b>            Less than 48 milliseconds using emitter/receiver with 610 mm to 813 mm defined area            Less than 60 milliseconds using emitter/receiver with 1016 mm to 1626 mm defined area            Less than 72 milliseconds using emitter/receiver with 1829 mm defined area</p> <p><b>E-Stop:</b> Less than 15 milliseconds</p>												
<b>Status Indicators</b> (on control box and receiver)	<table border="0"> <thead> <tr> <th></th> <th><b>Solid LED</b></th> <th><b>Flashing LED</b></th> </tr> </thead> <tbody> <tr> <td><b>Red</b></td> <td>BLOCKED/LATCHED</td> <td>LOCKOUT</td> </tr> <tr> <td><b>Green</b></td> <td>CLEAR</td> <td>BLANKING ON</td> </tr> <tr> <td><b>Yellow</b></td> <td>RESET</td> <td>Double Flash = Waiting for Power-up Key Reset Single Flash = ALIGNMENT. Flash rate increases with the number of sensing beams "made", solid yellow when aligned and defined area is clear</td> </tr> </tbody> </table>		<b>Solid LED</b>	<b>Flashing LED</b>	<b>Red</b>	BLOCKED/LATCHED	LOCKOUT	<b>Green</b>	CLEAR	BLANKING ON	<b>Yellow</b>	RESET	Double Flash = Waiting for Power-up Key Reset Single Flash = ALIGNMENT. Flash rate increases with the number of sensing beams "made", solid yellow when aligned and defined area is clear
	<b>Solid LED</b>	<b>Flashing LED</b>											
<b>Red</b>	BLOCKED/LATCHED	LOCKOUT											
<b>Green</b>	CLEAR	BLANKING ON											
<b>Yellow</b>	RESET	Double Flash = Waiting for Power-up Key Reset Single Flash = ALIGNMENT. Flash rate increases with the number of sensing beams "made", solid yellow when aligned and defined area is clear											
<b>Diagnostic Indicator</b>	Single-digit alphanumeric display indicates cause of lockout condition.												
<b>Controls and Adjustments</b>	Keyed Reset of system lockout and latched conditions Blanking selection switches Auto Power Up On-Off switches												
<b>E-Stop Switch Input</b>	Emergency stop switch must offer two normally closed contacts and be capable of switching 50 mA @ 30V dc. Simultaneity less than 100 milliseconds. Total resistance, including wiring and all switches, must not exceed 30 $\Omega$ for proper operation. Functional stop category 0 per NFPA 79 and EN 418, Safety Category 4 per EN 954-1.												
<b>Auxiliary Monitor Relay (x2)</b>	Reed relay; 125V ac or dc max., 500 mA max. (10 VA max., resistive load)												
<b>Safety Outputs</b>	Forced-guided contact relays (resistive load) FSD1 & 2, SSD = 250V ac max., 4 amps max. <b>Mechanical life:</b> 10,000,000 operations (minimum) <b>Electrical life:</b> 100,000 operations (typical @ 1.0 kVA switching power) <i>Arc suppression is recommended when switching inductive loads.</i>												
<b>Enclosure</b>	<b>Material:</b> Polycarbonate <b>Rating:</b> NEMA 1; IEC IP20												
<b>Operating Conditions</b>	<b>Temperature:</b> 0° to +50° C <b>Relative humidity:</b> 95% maximum (non-condensing)												
<b>FMEA Tested</b>	Per requirements of proposed first edition of IEC 61496-1 (Type 4)												
<b>Certifications</b>	For a list of certifications see page 236.												
<b>Wiring Diagrams</b>	<b>2 FSDs, 1 SSD and Power Monitoring:</b> WD025 (p. 259)												

# EZ-SCREEN® Type 2 Light Screens

- A low-cost solution is suited to lower-risk applications where the result of an accident is only a slight injury such as a bump, bruise, knockdown or trapping (but not crushing), minor cuts and abrasions.
- Simple two-piece system requires no control box.
- 30 mm resolution detects narrow objects, such as a hand or ankle across long spans up to 15 m.
- System meets all requirements for Type 2 applications per IEC61496-1/-2 and Category 2 per EN 954-1.
- System performs internal self-tests, with typical installations requiring additional external safety function checks.
- Dedicated models eliminate selectable functions, DIP switches and programming.
- Trip output model automatically resets when the beam is cleared; Latch output model requires a manual reset.
- Fast response times of 11 to 25 milliseconds shutdown machinery quickly.

**See page 180.**

### Effortless diagnostics.

Intuitive EZ-SCREEN Type 2 status LEDs indicate

- Power ON
- Fault (flashing LED)
- Beam alignment, top and bottom
- Beam/output status: blocked or clear

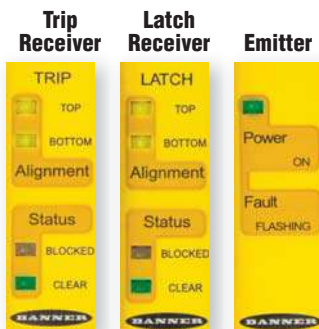

**Q&A: Type 2 vs Type 4**

### Choosing Type 2 vs. Type 4

The international standard IEC 61496 specifies requirements for the design, construction and testing for two levels or “types” of light screens to ensure the appropriate safety-related performance.

Light Screen	Type 2	Type 4
Cost/features	<ul style="list-style-type: none"> <li>• Lower cost</li> <li>• Single microprocessor</li> <li>• Two safety outputs</li> </ul>	<ul style="list-style-type: none"> <li>• Two microprocessors</li> <li>• Two safety outputs</li> <li>• Control reliable/Category 4</li> <li>• More features and range</li> </ul>
Functionality	<ul style="list-style-type: none"> <li>• Faults detected by self-test or periodic external test</li> <li>• Fault exclusion increases the integrity of the safety function</li> </ul>	<ul style="list-style-type: none"> <li>• Faults detected by self-test</li> <li>• High levels of fault tolerance through redundancy and monitoring</li> </ul>
Effective Aperture Angle (EAA)	<ul style="list-style-type: none"> <li>• Larger <math>\pm 5.0^\circ</math> EAA (field-of-view)</li> <li>• More susceptible to optical short circuits</li> </ul>	<ul style="list-style-type: none"> <li>• Smaller <math>\pm 2.5^\circ</math> EAA (field-of-view)</li> <li>• Less susceptible to optical short circuits</li> </ul>
Applications	<ul style="list-style-type: none"> <li>• Low- to moderate-risk applications where injury is slight</li> <li>• Automated production equipment, “table-top” robotic work cells, “pick and place” machines, small packaging machines, equipment protection and supplemental safeguarding</li> </ul>	<ul style="list-style-type: none"> <li>• High-risk applications that can result in severe injury or death</li> <li>• Primary safeguard in hazardous situations</li> <li>• Injuries that result in an OSHA recordable incident</li> <li>• Where mandated by a relevant standard</li> </ul>
Assessing Risk	<p>Conduct a risk assessment of your machine. Level of risk depends on the severity of harm and probability of occurrence. In the USA, if severity of harm is high, regardless of probability, you must choose a Type 4 safety light screen. See ISO 14121, ANSI B11 TR3, and ANSI/RIA R15.06 for more specific information.</p>	



## EZ-SCREEN® Type 2 Systems

- Economical, compact optical safeguarding
- Type 2 per IEC 61496-1/-2
- 30 mm resolution and 15 m range
- 24V dc supply voltage
- Latch or trip output
- 8-pin Euro QD connection
- QD cables ordered separately (see page 176)
- IEC IP65 housing

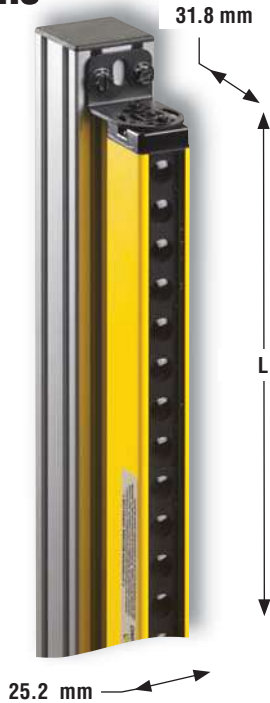

Full View



**EZ-SCREEN Type 2**

**Yellow Painted Aluminum**

## EZ-SCREEN® Type 2 Systems, 30 mm Resolution

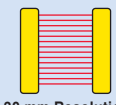

Model Number	Resolution	Output	Range	Defined Area	Housing Length (L)	Supply Voltage	Safety Outputs	Response Time	Connection	Data Sheet
LS2TP30-150Q88 <sup>†</sup> LS2E30-150Q8 LS2TR30-150Q8	 30 mm Resolution	Trip	15 m	150 mm	215 mm	24V dc	2 PNP OSSD	≤ 11 ms	8-pin Euro QD	122452
LS2LP30-150Q88 <sup>†</sup> LS2E30-150Q8 LS2LR30-150Q8		Latch								
LS2TP30-300Q88 <sup>†</sup> LS2E30-300Q8 LS2TR30-300Q8		Trip		300 mm	365 mm			≤ 13 ms		
LS2LP30-300Q88 <sup>†</sup> LS2E30-300Q8 LS2LR30-300Q8		Latch								
LS2TP30-450Q88 <sup>†</sup> LS2E30-450Q8 LS2TR30-450Q8		Trip		450 mm	515 mm			≤ 14 ms		
LS2LP30-450Q88 <sup>†</sup> LS2E30-450Q8 LS2LR30-450Q8		Latch								

 30 mm Resolution

<sup>†</sup> A pair includes an emitter and receiver (example, LS2TP30-150Q88). Emitters (example, LS2E30-150Q8) and receivers (example, LS2TR30-150Q8) are sold separately.

# SAFETY LIGHT SCREENS

## EZ-SCREEN® TYPE 2 Systems

### EZ-SCREEN® Type 2 Systems, 30 mm Resolution (cont'd)



SAFETY LIGHT SCREENS

EZ-SCREEN®

PICO-GUARD®

MICRO-SCREEN®

MINI-SCREEN®

EZ-SCREEN®  
TYPE 2

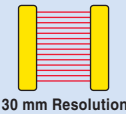
Model Number	Resolution	Output Range	Defined Area	Housing Length (L)	Supply Voltage	Safety Outputs	Response Time	Connection	Data Sheet	
LS2TP30-600Q88† LS2E30-600Q8 LS2TR30-600Q8	 30 mm Resolution	Trip	15 m	600 mm	24V dc	2 PNP OSSD	≤ 16 ms	8-pin Euro QD	122452	
LS2LP30-600Q88† LS2E30-600Q8 LS2LR30-600Q8		Latch								665 mm
LS2TP30-750Q88† LS2E30-750Q8 LS2TR30-750Q8		Trip		750 mm			815 mm			≤ 17 ms
LS2LP30-750Q88† LS2E30-750Q8 LS2LR30-750Q8		Latch		900 mm			964 mm			≤ 19 ms
LS2TP30-900Q88† LS2E30-900Q8 LS2TR30-900Q8		Trip		900 mm			964 mm			≤ 19 ms
LS2LP30-900Q88† LS2E30-900Q8 LS2LR30-900Q8		Latch		1050 mm			1114 mm			≤ 21 ms
LS2TP30-1050Q88† LS2E30-1050Q8 LS2TR30-1050Q8		Trip		1050 mm			1114 mm			≤ 21 ms
LS2LP30-1050Q88† LS2E30-1050Q8 LS2LR30-1050Q8		Latch		1200 mm			1264 mm			≤ 22 ms
LS2TP30-1200Q88† LS2E30-1200Q8 LS2TR30-1200Q8		Trip		1200 mm			1264 mm			≤ 22 ms
LS2LP30-1200Q88† LS2E30-1200Q8 LS2LR30-1200Q8		Latch		1350 mm			1414 mm			≤ 24 ms
LS2TP30-1350Q88† LS2E30-1350Q8 LS2TR30-1350Q8		Trip		1350 mm			1414 mm			≤ 24 ms
LS2LP30-1350Q88† LS2E30-1350Q8 LS2LR30-1350Q8		Latch								



† A pair includes an emitter and receiver (example, LS2TP30-600Q88). Emitters (example, LS2E30-600Q8) and receivers (example, LS2TR30-600Q8) are sold separately.

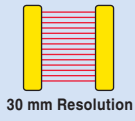

## EZ-SCREEN® Type 2 Systems, 30 mm Resolution (cont'd)

Model Number	Resolution	Output	Range	Defined Area	Housing Length (L)	Supply Voltage	Safety Outputs	Response Time	Connec-tion	Data Sheet
LS2TP30-1500Q88 <sup>†</sup> LS2E30-1500Q8 LS2TR30-1500Q8		Trip	15 m	1500 mm	1563 mm	24V dc	<b>2 PNP OSSD</b>	≤ 25 ms	8-pin Euro QD	122452
LS2LP30-1500Q88 <sup>†</sup> LS2E30-1500Q8 LS2LR30-1500Q8		Latch								

 30 mm Resolution

<sup>†</sup> A pair includes an emitter and receiver (example, **LS2TP30-1500Q88**). Emitters (example, **LS2E30-1500Q8**) and receivers (example, **LS2TR30-1500Q8**) are sold separately.

EZ-SCREEN®

PICO-GUARD®

MICRO-SCREEN®

MINI-SCREEN®

**EZ-SCREEN® TYPE 2**



# EZ-SCREEN® Type 2 Interfacing Products

SAFETY LIGHT SCREENS



EZ-SCREEN®

PICO-GUARD®

MICRO-SCREEN®

MINI-SCREEN®

EZ-SCREEN® TYPE 2

	Models	Description	Product Information	Data Sheet
<b>Interface Modules</b>	 <b>IM-T-9A</b> (3 NO)	<ul style="list-style-type: none"> <li>Interface modules provide two or three normally open force-guided relay outputs rated at 6 A.</li> <li>EZ-SCREEN monitors these interface modules when they are connected to the EZ-SCREEN External Device Monitoring (EDM) inputs.</li> <li>Convenient plug-in terminal blocks on a 22.5 mm DIN-rail mountable housing are included.</li> </ul>	Page 132	62822
	<b>IM-T-11A</b> (2 NO/1 NC)			
<b>Muting Modules</b>	 <b>MM2-TA-12B</b>	<ul style="list-style-type: none"> <li>The Muting Module temporarily inhibits a safety light screen so materials can safely pass through the screen without stopping the machinery.</li> <li>The module uses redundant microcontroller-based logic.</li> </ul>	Page 123	63517
	<b>MMD-TA-12B</b>			116390
	<b>MMD-TA-11B</b>			
<b>Contactor Products</b>	 <b>Mechanically Linked Contactors</b>	<ul style="list-style-type: none"> <li>Pairs of contactors create safety stop circuits with two normally open contacts in series.</li> <li>EZ-SCREEN can monitor the circuit because of the contacts' force-guided mechanically linked design.</li> <li>Contactors add 10 or 16 amp current carrying capability to any safety system.</li> <li>Auxiliary contacts add 3 or 4 normally open contacts.</li> <li>Suppressors extend the life of an actuating device that uses a contactor.</li> <li>Modular design simplifies assembly and installation.</li> </ul>	Page 186	111881
	<b>11-BG00-31-D-024</b>			
	<b>11-BF16C01-024</b>			
	<b>Aux. Contacts</b>			
	<b>11-BGX10-40</b>			
	<b>11-G484-30</b>			
	<b>Suppressors</b>			
<b>11-BGX77-048</b>				
<b>11-G318-48</b>				

## EZ-SCREEN® Type 2 Kits



You can purchase a kit that contains an emitter and receiver of equal length; brackets; and optional interfacing solution and quick-disconnect cables. Detailed information about individual kit components is as follows.

- Emitter and Receivers ..... Page 79
- Interfacing Options..... 82
- Cables ..... 176
- Brackets ..... 190

A **partial listing** of kits is listed below; see Kit Model Key to order other variations.

Kit Model Number	Protected Height	Resolution	Range	Supply Voltage	No. of Outputs	Output Type	Emitter & Receiver Connection	Interfacing Options	QD Cabling
LS2TK30-600Q88-1RE25	600 mm	30 mm	18 m	24V dc	2 OSSD	Trip	Integral Euro QD	IM-T-9A, 1 each	8 m, 2 each
LS2LK30-600Q88-1RE25						Latch			
LS2TK30-750Q88-1RE25	750 mm					Trip			
LS2LK30-750Q88-1RE25						Latch			

## Kit Model Key

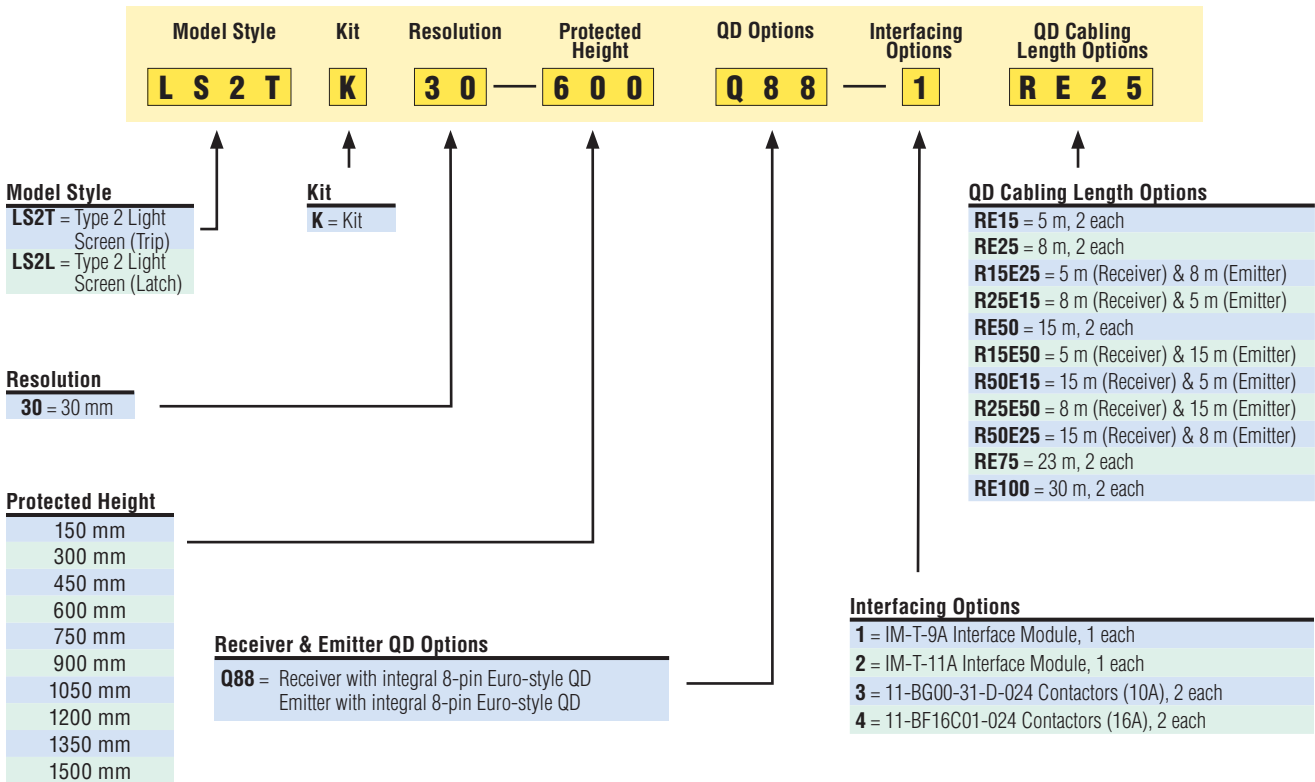

NOTE: Not all combinations are possible. Contact Banner Engineering Corp. for additional information and/or verification of valid kit model number.

## EZ-SCREEN® Type 2 Specifications

Supply Voltage at the Device*	24V dc $\pm$ 20% (PELV)
Supply Current*	<b>Emitter:</b> 50 mA max. <b>Receiver:</b> 90 mA max., exclusive of OSSD1 and OSSD2 loads (up to an additional 0.5A each)
Wavelength of Emitter Elements	Infrared LEDs, 950 nm at peak emission
Short Circuit Protection	All inputs and outputs are protected from short circuits to +24V dc or dc common*
Electrical Safety Class	III (per IEC 61140: 1997)
Safety Rating	Type 2 per IEC 61496-1, -2; Category 2 per EN 954-1
Operating Range	0.2 m to 15 m Range decreases with use of mirrors and/or lens shields: <b>Lens shields</b> – approximately 10% less range per shield. <b>Glass-surface mirrors</b> – approximately 8% less range per mirror. See Accessory section for more information on a specific mirror, page 204.
Effective Aperture Angle (EAA)	Meets Type 2 requirements per IEC 61496-2; $\pm 5^\circ$ @ 3 m
Ambient Light Immunity	> 10,000 lux at $5^\circ$ angle of incidence
Strobe Light Immunity	Immune as per IEC 61496-2
Response Time	Dependent on number of beams; see Models table on page 79.
EDM Input	“Power Monitoring” accomplished via Reset/Remote Test input
Reset Input / Remote Test Input	Connect to +24V dc via a normally closed (NC) reset switch <b>Auto Rest (Trip Output) Models:</b> Test/Reset <b>Manual Rest (Latch Output) Models:</b> Test/Restart/Reset
Safety Outputs	Two redundant solid-state 24V dc, 0.5 A max. sourcing OSSD (Output Signal Switching Device) safety outputs. (Use optional interface modules for ac or larger dc loads.) Not compatible with the Banner “Safety Handshake.” <b>ON-State voltage:</b> > $V_{in}-1.5V$ dc <b>OFF-State voltage:</b> 0.2V dc max. <b>Max. load capacitance:</b> 0.1 $\mu$ F <b>Min. load resistance:</b> 48 $\Omega$ <b>Open ground leakage current:</b> 0.65 mA max. <b>OSSD test pulse width:</b> 0.25 milliseconds <b>OSSD test pulse period:</b> 500 milliseconds
Enclosure	<b>Materials:</b> Extruded aluminum housing with yellow polyester powder finish and well-sealed, rugged die-cast zinc end caps, acrylic lens cover <b>Rating:</b> IEC IP65
Operating Conditions	<b>Temperature:</b> $0^\circ$ to $+55^\circ$ C <b>Relative humidity:</b> 95% maximum (non-condensing)
Shock and Vibration	EZ-SCREEN Type 2 systems have passed vibration and shock tests according to IEC 61496-1. This includes vibration (10 cycles) of 10-55 Hz at 0.35 mm single amplitude (0.70 mm peak-to-peak) and shock of 10 g for 16 milliseconds (6,000 cycles).
Certifications	For a list of certifications see page 236.
Wiring Diagrams	<b>Emitter:</b> WD026 (p. 260) <b>Receiver with 2 Solid-State OSSDs, 2 FSDs and Power Monitoring:</b> WD027 (p. 260) <b>Power Monitoring of IM-T-9A Interface Module:</b> WD028 (p. 261)

\*The external voltage supply must be capable of buffering brief mains interruptions of 20 milliseconds as specified in IEC/EN 60204-1.