



**Documentation**

# **CU20xx, CU22xx**

**Ethernet Switch**

**Version: 2.1**  
**Date: 2017-12-18**

**BECKHOFF**



# 1 CU20xx, CU22xx - Product overview

[CU2005](#) [▶ 8] - 5 RJ-45-Ethernet-Ports

[CU2008](#) [▶ 8] - 8 RJ-45-Ethernet-Ports

[CU2208](#) [▶ 8] - 8 RJ-45-GBit-Ethernet-Ports

[CU2016](#) [▶ 8] - 16 RJ-45-Ethernet-Ports

# Table of contents

|          |  |           |
|----------|--|-----------|
| <b>1</b> | <b>CU20xx, CU22xx - Product overview</b> ..... | <b>3</b>  |
| <b>2</b> | <b>Foreword</b> .....                          | <b>5</b>  |
| 2.1      | Notes on the documentation .....               | 5         |
| 2.2      | Safety instructions .....                      | 6         |
| 2.3      | Documentation issue status .....               | 7         |
| <b>3</b> | <b>Product overview</b> .....                  | <b>8</b>  |
| 3.1      | Introduction .....                             | 8         |
| 3.2      | Technical data .....                           | 9         |
| 3.3      | Basic function principles .....                | 10        |
| <b>4</b> | <b>Assembly and commissioning</b> .....        | <b>11</b> |
| 4.1      | Dimensions .....                               | 11        |
| 4.2      | Mounting and demounting .....                  | 13        |
| 4.3      | Cabling .....                                  | 15        |
| 4.4      | LED Displays .....                             | 16        |
| <b>5</b> | <b>Appendix</b> .....                          | <b>17</b> |
| 5.1      | UL notice .....                                | 17        |
| 5.2      | Support and Service .....                      | 18        |

## 2 Foreword

### 2.1 Notes on the documentation

#### Intended audience

This description is only intended for the use of trained specialists in control and automation engineering who are familiar with the applicable national standards.

It is essential that the documentation and the following notes and explanations are followed when installing and commissioning these components.

It is the duty of the technical personnel to use the documentation published at the respective time of each installation and commissioning.

The responsible staff must ensure that the application or use of the products described satisfy all the requirements for safety, including all the relevant laws, regulations, guidelines and standards.

#### Disclaimer

The documentation has been prepared with care. The products described are, however, constantly under development.

We reserve the right to revise and change the documentation at any time and without prior announcement.

No claims for the modification of products that have already been supplied may be made on the basis of the data, diagrams and descriptions in this documentation.

#### Trademarks

Beckhoff®, TwinCAT®, EtherCAT®, Safety over EtherCAT®, TwinSAFE®, XFC® and XTS® are registered trademarks of and licensed by Beckhoff Automation GmbH.

Other designations used in this publication may be trademarks whose use by third parties for their own purposes could violate the rights of the owners.

#### Patent Pending

The EtherCAT Technology is covered, including but not limited to the following patent applications and patents: EP1590927, EP1789857, DE102004044764, DE102007017835 with corresponding applications or registrations in various other countries.

The TwinCAT Technology is covered, including but not limited to the following patent applications and patents: EP0851348, US6167425 with corresponding applications or registrations in various other countries.

The logo for EtherCAT, featuring the word "EtherCAT" in a bold, black, sans-serif font. A red arrow points from the top of the "A" towards the right, ending above the "T". A registered trademark symbol (®) is located to the right of the "T".

EtherCAT® is registered trademark and patented technology, licensed by Beckhoff Automation GmbH, Germany

#### Copyright

© Beckhoff Automation GmbH & Co. KG, Germany.

The reproduction, distribution and utilization of this document as well as the communication of its contents to others without express authorization are prohibited.

Offenders will be held liable for the payment of damages. All rights reserved in the event of the grant of a patent, utility model or design.

## 2.2 Safety instructions

### Safety regulations

Please note the following safety instructions and explanations!  
Product-specific safety instructions can be found on following pages or in the areas mounting, wiring, commissioning etc.

### Exclusion of liability





All the components are supplied in particular hardware and software configurations appropriate for the application. Modifications to hardware or software configurations other than those described in the documentation are not permitted, and nullify the liability of Beckhoff Automation GmbH & Co. KG.

### Personnel qualification

This description is only intended for trained specialists in control, automation and drive engineering who are familiar with the applicable national standards.

### Description of symbols

In this documentation the following symbols are used with an accompanying safety instruction or note. The safety instructions must be read carefully and followed without fail!

|   |   |
|---|---|
| <br><b>DANGER</b>      | <p><b>Serious risk of injury!</b><br/>Failure to follow the safety instructions associated with this symbol directly endangers the life and health of persons.</p>        |
| <br><b>WARNING</b>   | <p><b>Risk of injury!</b><br/>Failure to follow the safety instructions associated with this symbol endangers the life and health of persons.</p>                         |
| <br><b>CAUTION</b>   | <p><b>Personal injuries!</b><br/>Failure to follow the safety instructions associated with this symbol can lead to injuries to persons.</p>                               |
| <br><b>Attention</b> | <p><b>Damage to the environment or devices</b><br/>Failure to follow the instructions associated with this symbol can lead to damage to the environment or equipment.</p> |
| <br><b>Note</b>      | <p><b>Tip or pointer</b><br/>This symbol indicates information that contributes to better understanding.</p>  |

## 2.3 Documentation issue status

| Version | Comment   |
|---------|---|
| 2.1     | - Update Technical data                             |
| 2.0     | - Migration<br>- Mounting and Commissioning updated |
| 1.4     | - Addenda "Basic function principles"               |
| 1.3     | - Addenda "Basic function principles"               |
| 1.2     | - CU2208 added                                      |
| 1.1     | - CU2005 added                                      |
| 1.0     | - Technical data added                              |
| 0.1     | - Preliminary Version                               |

## 3 Product overview

### 3.1 Introduction



Fig. 1: CU2008, CU2208, CU2005, CU2016

The Beckhoff Ethernet switches offer five, eight or sixteen RJ45 Ethernet ports. Switches relay incoming Ethernet frames to the destination ports. In full duplex mode, they prevent collisions. They can be used universally in automation and office networks. User-friendly installation via integrated mounting rail adapter.

Their particular suitability for use in the industrial environment is underlined by the following benefits:

- Compact design in metal housing
- 10/100 Mbaud (CU2208: 1000 Mbaud) with automatic baud rate detection
- Half or full duplex operation
- Cross-over detection: automatic detection and correction of crossover and straight-through Ethernet cables
- Fast diagnosis with 2 LEDs per Ethernet port directly on the RJ45 socket
- simple mounting on DIN rails [► 13]
- Industrial design



## 3.2 Technical data

| Technical data   | CU2005   | CU2008                         | CU2016                            | CU2208  |
|--|--|--------------------------------|-----------------------------------|---|
| Bus system   | Ethernet (all IEEE 802.3-based protocols)<br>Store-and-forward switching mode, unmanaged   |                                |                                   |   |
| Number of Ethernet ports                               | 5  | 8                              | 16                                | 8   |
| Ethernet interface                                     | 10BASE-T/100BASE-TX<br>Ethernet with RJ45  |                                |                                   | 10BASE-T/100BASE-TX/1000BASE-T<br>Ethernet with RJ45                                      |
| Cable length   | up to 100 m twisted pair, switches cascadable without restriction  |                                |                                   |   |
| Baud rate  | 10/100 Mbit/s, IEEE 802.3u auto-negotiation, half or full duplex, automatic settings   |                                |                                   | 10/100/1000 Mbit/s, IEEE 802.3u auto-negotiation, half or full duplex, automatic settings |
| Diagnosis  | 2 LEDs per channel:<br>- Link/Activity<br>- 100 Mbit   |                                |                                   | 2 LEDs per channel:<br>- Link/Activity<br>- 1000 Mbit                                     |
| Power supply   | via three-pole spring loaded terminal (+, -, PE)   |                                |                                   |   |
| Supply voltage   | 24 V <sub>DC</sub> (18 V <sub>DC</sub> to 30 V <sub>DC</sub> ), protected against polarity reversal. Observe <a href="#">UL note [► 17]!</a> |                                |                                   |   |
| Current consumption                                    | typically 90 mA  | typically 100 mA               | typically 150 mA                  | typically 180 mA  |
| Weight   | approx. 270 g  | approx. 340 g                  | approx. 540 g                     | approx. 430 g   |
| Dimensions without plugs (W x H x D)                   | approx. 73 mm x 100 mm x 38 mm   | approx. 85 mm x 100 mm x 38 mm | approx. 146.5 mm x 100 mm x 38 mm | approx. 122 mm x 100 mm x 38 mm   |
| <a href="#">Mounting [► 13]</a>                        | on 35 mm DIN rail (mounting rail according to EN 50022)  |                                |                                   |   |
| permissible ambient temperature range during operation | 0°C ... + 55°C   |                                |                                   |   |
| permissible ambient temperature range during storage   | -25°C ... + 85°C   |                                |                                   |   |
| permissible relative humidity                          | 95 %, no condensation  |                                |                                   |   |
| Vibration/shock resistance                             | conforms to EN 60068-2-6 / EN 60068-2-27, EN 60068-2-29  |                                |                                   |   |
| EMC immunity/emission                                  | conforms to EN 61000-6-2 / EN 61000-6-4  |                                |                                   |   |
| Protection class                                       | IP20   |                                |                                   |   |
| Installation position                                  | variable   |                                |                                   |   |
| Approval   | CE<br><a href="#">cULus [► 17]</a>   |                                |                                   |   |

## 3.3 Basic function principles

### Store and Forward

The switch operates according to the *store-and-forward* principle. Frames that are faulty (CRC error), too short (< 64 bytes) or too long (> 1536 bytes) are generally not passed on.

### Address Memory

The switch learns the MAC addresses of the connected devices for each port. Only frames that have these addresses, broadcast/or multi-cast addresses, or which have unknown addresses are passed on to this port. Because the switch remembers more than 1000 addresses for each port, it is also suitable for connecting entire network segments. After approx. 5 minutes (Aging Time) unused addresses are removed from the memory – if required, they are re-learnt again later.

### Throughput

The switch can pass through up to 148800 Ethernet frames per second (Wire Speed).

### PoE - Power over Ethernet

The CU20xx, CU22xx and CU26xx switches do not support PoE according to IEEE 802.3; they do not reveal themselves as PSE (power sourcing equipment) or PD (powered devices). Any PSE connected to the switch must therefore not apply a voltage.

No provision is made in the standard for passive interconnection or distribution.

### Jumbo Frames

Jumbo Frames are oversized Ethernet telegrams with a length of more than 1518 bytes. They are used in applications that require very high data throughput, for example.

The CU2208 (from hardware version 01) supports Jumbo Frames up to 9720 bytes on all ports. Please note the following:

- Jumbo Frames only supported by ports with Gbit link
- Jumbo Frames place high demands on internal data transmission. It is therefore necessary to assess the data throughput that can be achieved through the CU2208 for each individual application. Under full load no more than 2 ports can be used for Jumbo Frames at the same time.

Jumbo Frames are not subject to standardization. It is therefore necessary to verify that the frames used by the application are supported by the CU2208.

## 4 Assembly and commissioning

### 4.1 Dimensions

- CU2005: approx. 73 mm x 100 mm x 38 mm
- CU2008: approx. 85 mm x 100 mm x 38 mm
- CU2208: approx. 122 mm x 100 mm x 38 mm
- CU2016: approx. 146.5 mm x 100 mm x 38 mm



**Note**

**Space requirement in the control cabinet**

- The RJ45 connector increase the depth depending on their design and the Ethernet cable used.
- Above the mounting rail an additional height of approx. 10 mm is required to enable latching [▶ 13] of the switch onto the rail.

**CU2005**

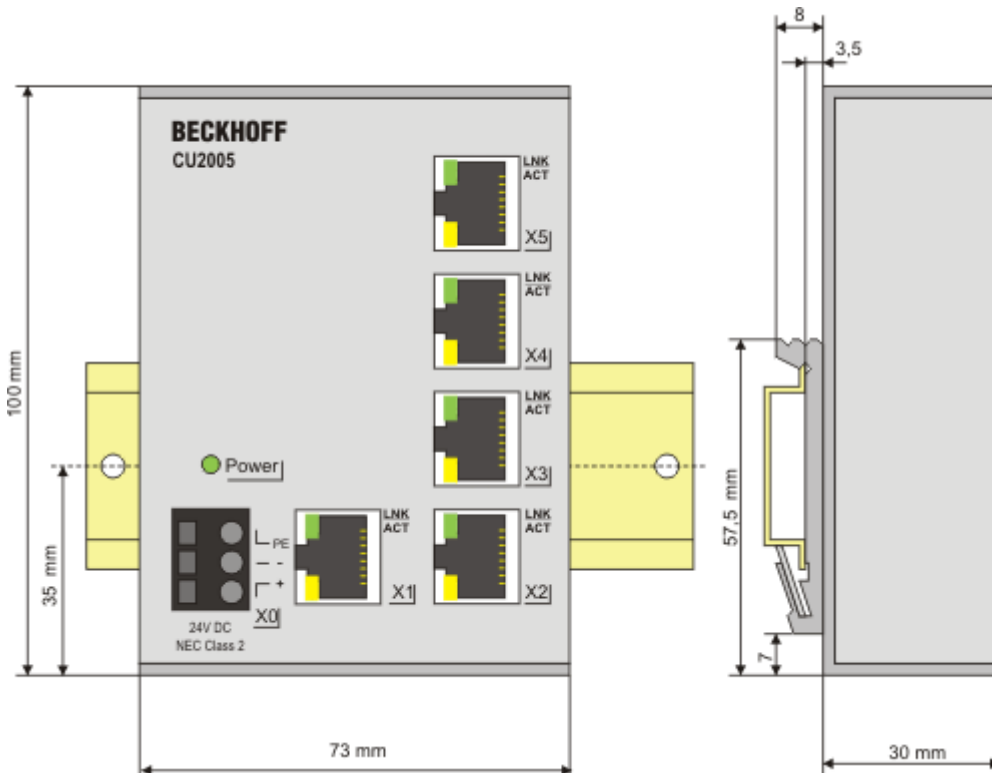

Fig. 2: CU2005

**CU2008**

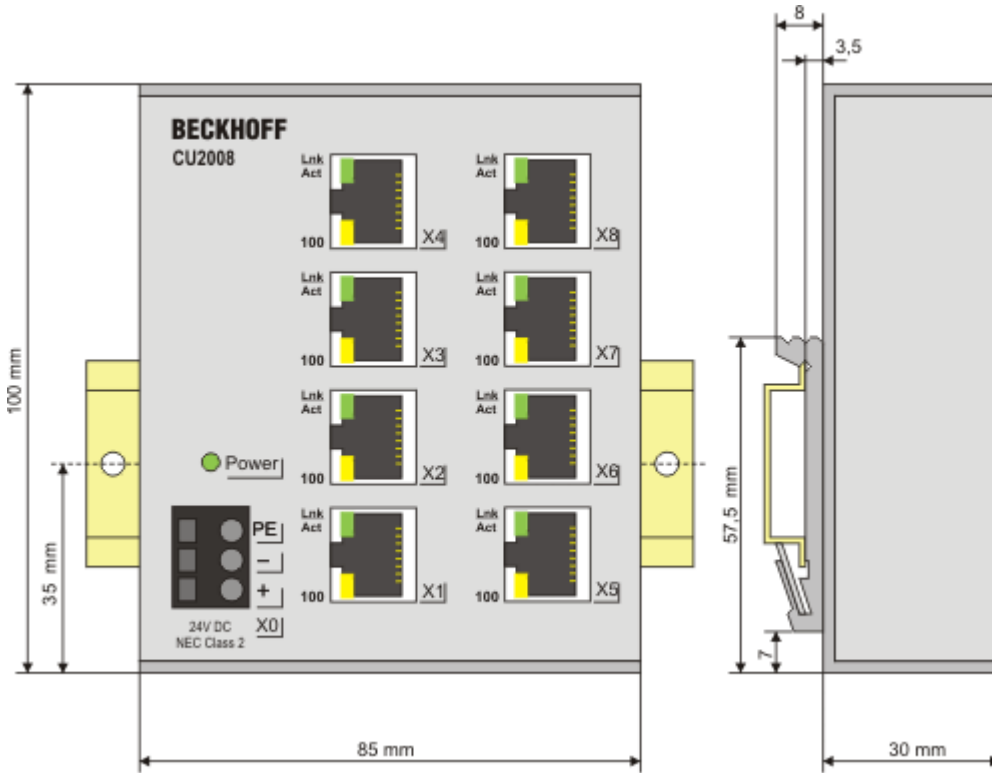

Fig. 3: CU2008

**CU2208**

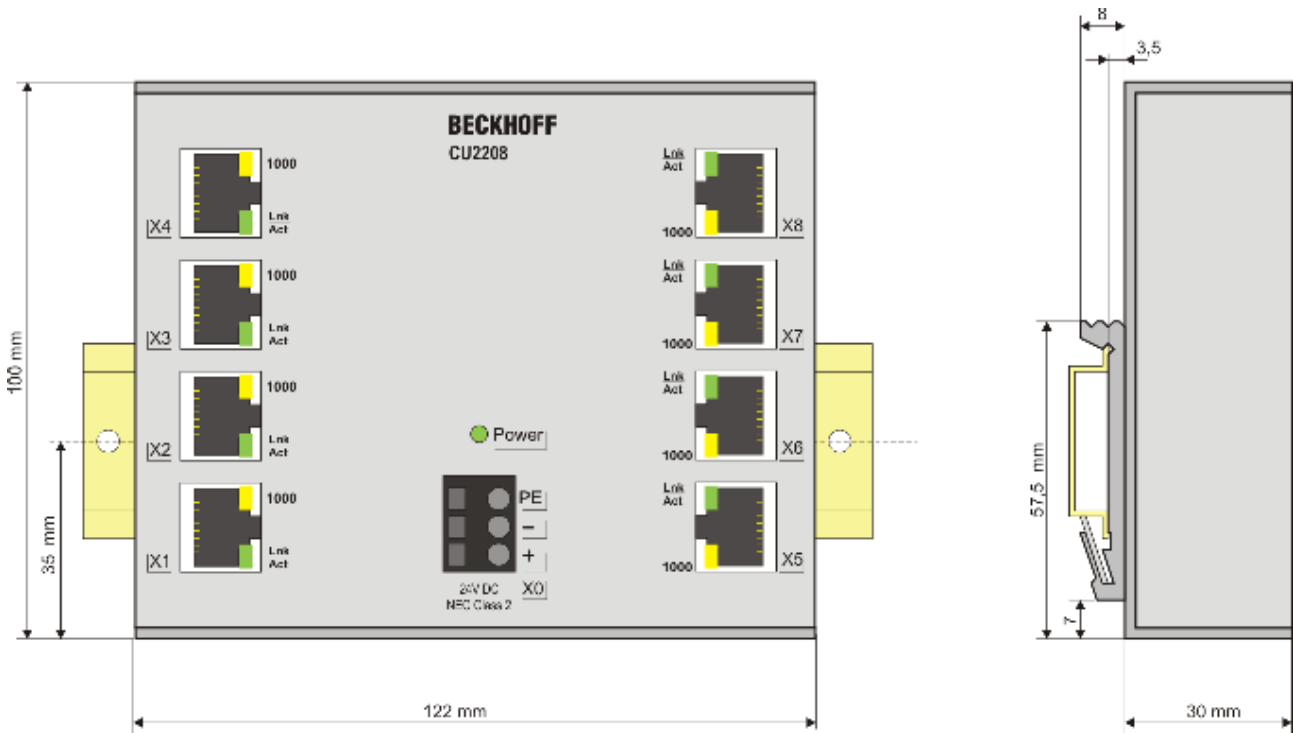

Fig. 4: CU2208

**CU2016**

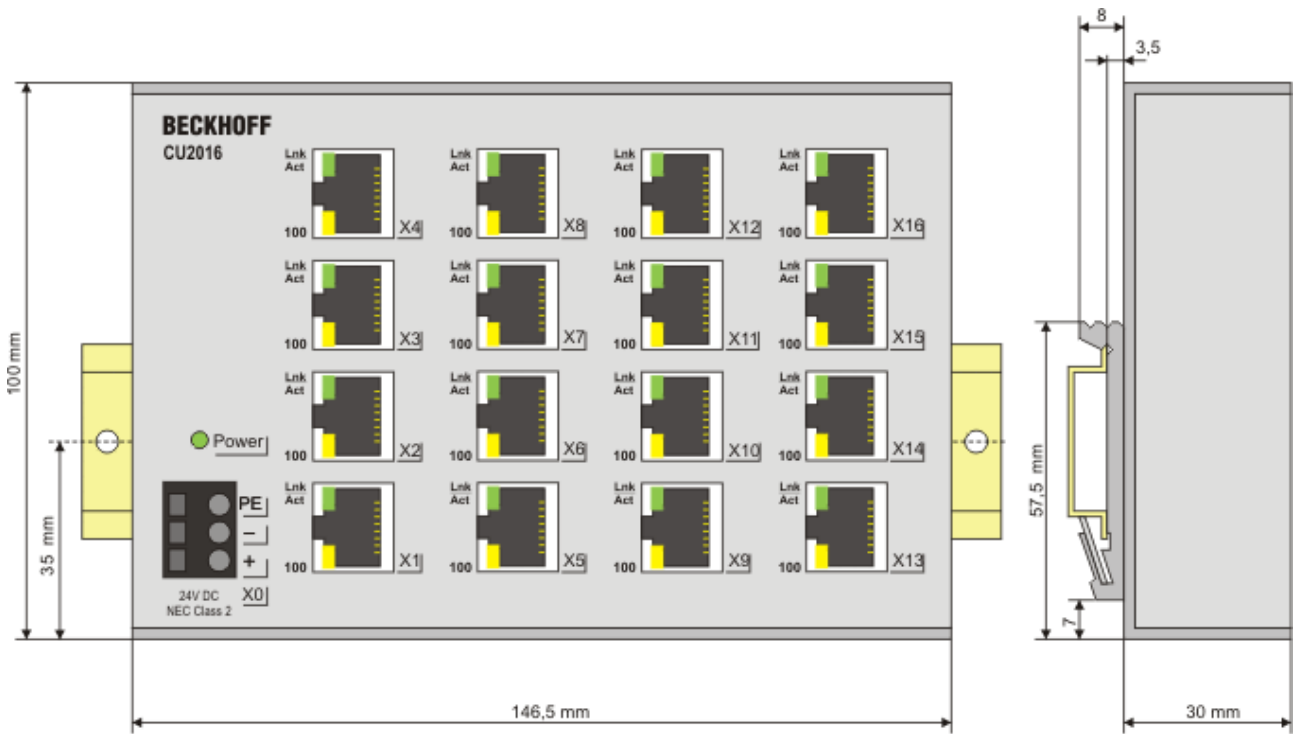

Fig. 5: CU2016

## 4.2 Mounting and demounting

The CU20xx und CU22xx switches are fastened to the mounting surface at 35 mm with the aid of a mounting rail according to EN 50022.

### Mounting

- Fit the mounting rail to the planned assembly location.
- Suspend the switch on the mounting rail with the spring on the lower side of its latching flange.
- Press the switch upwards (1).
- Press the upper side of the switch (2) against the assembly surface until it latches in the mounting rail.
- Attach the cable.

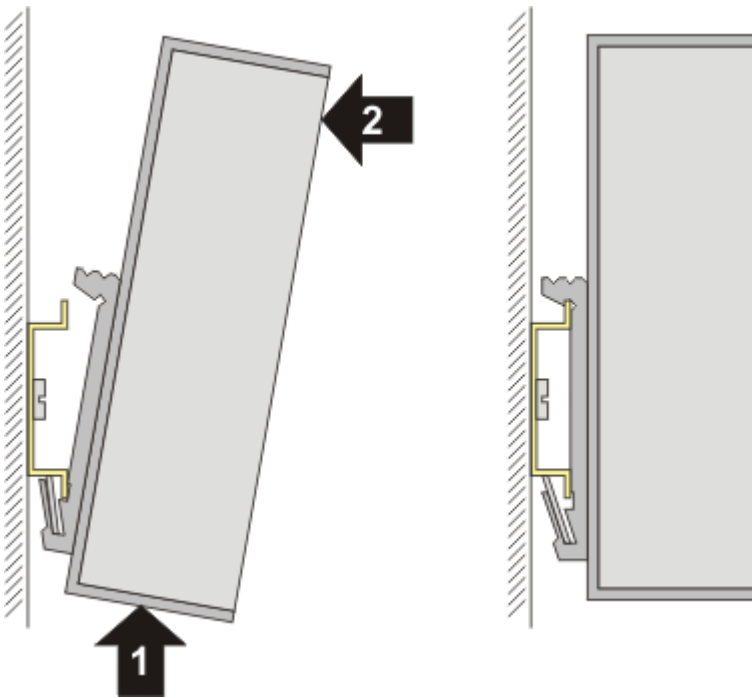

Fig. 6: Mounting

**Removal**

- Remove all the cables.
- Press the switch upwards (3).
- Pull the other side of the switch (4) away from the assembly surface.

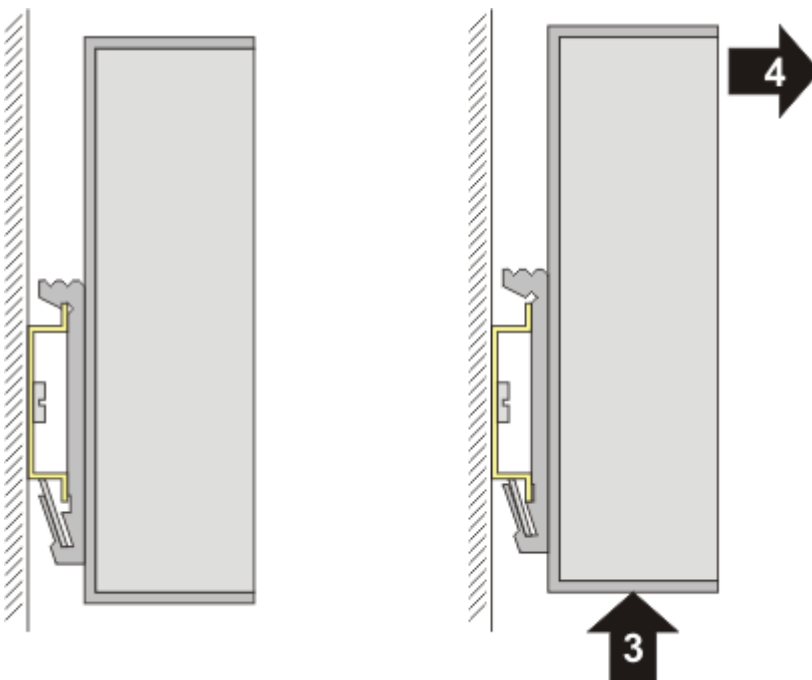

Fig. 7: Removal

## 4.3 Cabling

### Power supply

#### Pin configuration of the spring loaded terminal

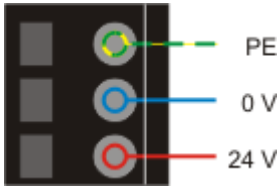

Fig. 8: CU20xx\_PowerClamp

|  |  |
|--|--|
|  | <p><b>UL requirements</b></p> <ul style="list-style-type: none"> <li>• from an isolated source protected by a fuse of max. 4A (according to UL248) or</li> <li>• from a voltage supply complying with <i>NEC class 2</i>.</li> <li>• An NEC class 2 voltage source must not be connected in series or parallel with another NEC class 2 voltage source! These requirements apply to the supply of all Bus Couplers, power supply terminals, Bus Terminals and their power contacts.</li> </ul> |
|--|--|

|  |   |
|--|---|
|  | <p><b>UL requirements</b></p> <p>In order to comply with UL requirements, the EtherCAT components must not be connected to unlimited voltage sources!</p> |
|--|---|

### Ethernet

#### Pin configuration of the RJ45 sockets

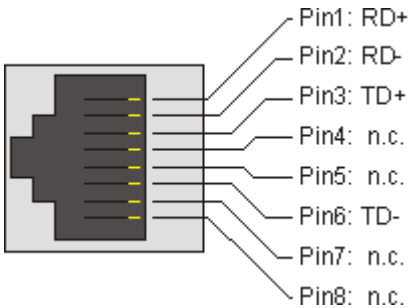

Fig. 9: Pin configuration of the RJ45 sockets

## 4.4 LED Displays

### Ethernet

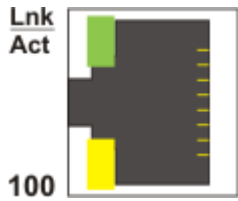

Fig. 10: LEDs

2 LEDs indicate the current state of each channel.

Table 1: LED display per channel

| LED         | Display  |  |
|-------------|----------|--|
| Link<br>Act | off      | No connection                                    |
|             | on       | Connection available (link)                      |
|             | flashing | Data transfer (act)                              |
| 100 (1000)  | on       | Connection with 100 Mbit/s (CU2208: 1000 Mbit/s) |

### Supply voltage

The presence of the supply voltage (24 V<sub>DC</sub>) is indicated by the green Power LED.





Fig. 11: Green Power LED



## 5 Appendix

### 5.1 UL notice

|   |   |
|---|---|
|  | <p><b>Application</b><br/>Beckhoff EtherCAT modules are intended for use with Beckhoff's UL Listed EtherCAT System only.</p>  |
|  | <p><b>Examination</b><br/>For cULus examination, the Beckhoff I/O System has only been investigated for risk of fire and electrical shock (in accordance with UL508 and CSA C22.2 No. 142).</p> |
|  | <p><b>For devices with Ethernet connectors</b><br/>Not for connection to telecommunication circuits.</p>  |

#### Basic principles

Two UL certificates are met in the Beckhoff EtherCAT product range, depending upon the components:

- UL certification according to UL508  
Devices with this kind of certification are marked by this sign:



Almost all current EtherCAT products (as at 2010/05) are UL certified without restrictions.

- UL certification according to UL508 with limited power consumption  
The current consumed by the device is limited to a max. possible current consumption of 4 A. Devices with this kind of certification are marked by this sign:

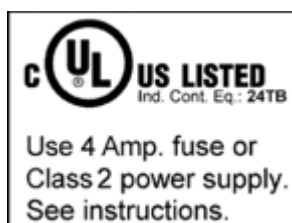

Almost all current EtherCAT products (as at 2010/05) are UL certified without restrictions.

#### Application

If terminals certified *with restrictions* are used, then the current consumption at 24 V<sub>DC</sub> must be limited accordingly by means of supply

- from an isolated source protected by a fuse of max. 4A (according to UL248) or
- from a voltage supply complying with *NEC class 2*.  
A voltage source complying with *NEC class 2* may not be connected in series or parallel with another *NEC class 2* compliant voltage supply!

These requirements apply to the supply of all EtherCAT bus couplers, power adaptor terminals, Bus Terminals and their power contacts.

## 5.2 Support and Service

Beckhoff and their partners around the world offer comprehensive support and service, making available fast and competent assistance with all questions related to Beckhoff products and system solutions.

### Beckhoff's branch offices and representatives

Please contact your Beckhoff branch office or representative for local support and service on Beckhoff products!

The addresses of Beckhoff's branch offices and representatives round the world can be found on her internet pages:

<http://www.beckhoff.com>

You will also find further documentation for Beckhoff components there.

### Beckhoff Headquarters

Beckhoff Automation GmbH & Co. KG

Huelshorstweg 20  
33415 Verl  
Germany

|         |                    |
|---------|--------------------|
| Phone:  | +49(0)5246/963-0   |
| Fax:    | +49(0)5246/963-198 |
| e-mail: | info@beckhoff.com  |

### Beckhoff Support

Support offers you comprehensive technical assistance, helping you not only with the application of individual Beckhoff products, but also with other, wide-ranging services:

- support
- design, programming and commissioning of complex automation systems
- and extensive training program for Beckhoff system components

|          |                      |
|----------|----------------------|
| Hotline: | +49(0)5246/963-157   |
| Fax:     | +49(0)5246/963-9157  |
| e-mail:  | support@beckhoff.com |

### Beckhoff Service

The Beckhoff Service Center supports you in all matters of after-sales service:

- on-site service
- repair service
- spare parts service
- hotline service

|          |                      |
|----------|----------------------|
| Hotline: | +49(0)5246/963-460   |
| Fax:     | +49(0)5246/963-479   |
| e-mail:  | service@beckhoff.com |

## List of illustrations

|         |   |    |
|---------|---|----|
| Fig. 1  | CU2008, CU2208, CU2005, CU2016 .....        | 8  |
| Fig. 2  | CU2005.....                                 | 11 |
| Fig. 3  | CU2008.....                                 | 12 |
| Fig. 4  | CU2208.....                                 | 12 |
| Fig. 5  | CU2016.....                                 | 13 |
| Fig. 6  | Mounting .....                              | 14 |
| Fig. 7  | Removal.....                                | 14 |
| Fig. 8  | CU20xx_PowerClamp .....                     | 15 |
| Fig. 9  | Pin configuration of the RJ45 sockets ..... | 15 |
| Fig. 10 | LEDs .....                                  | 16 |
| Fig. 11 | Green Power LED.....                        | 16 |