

Selection diagram

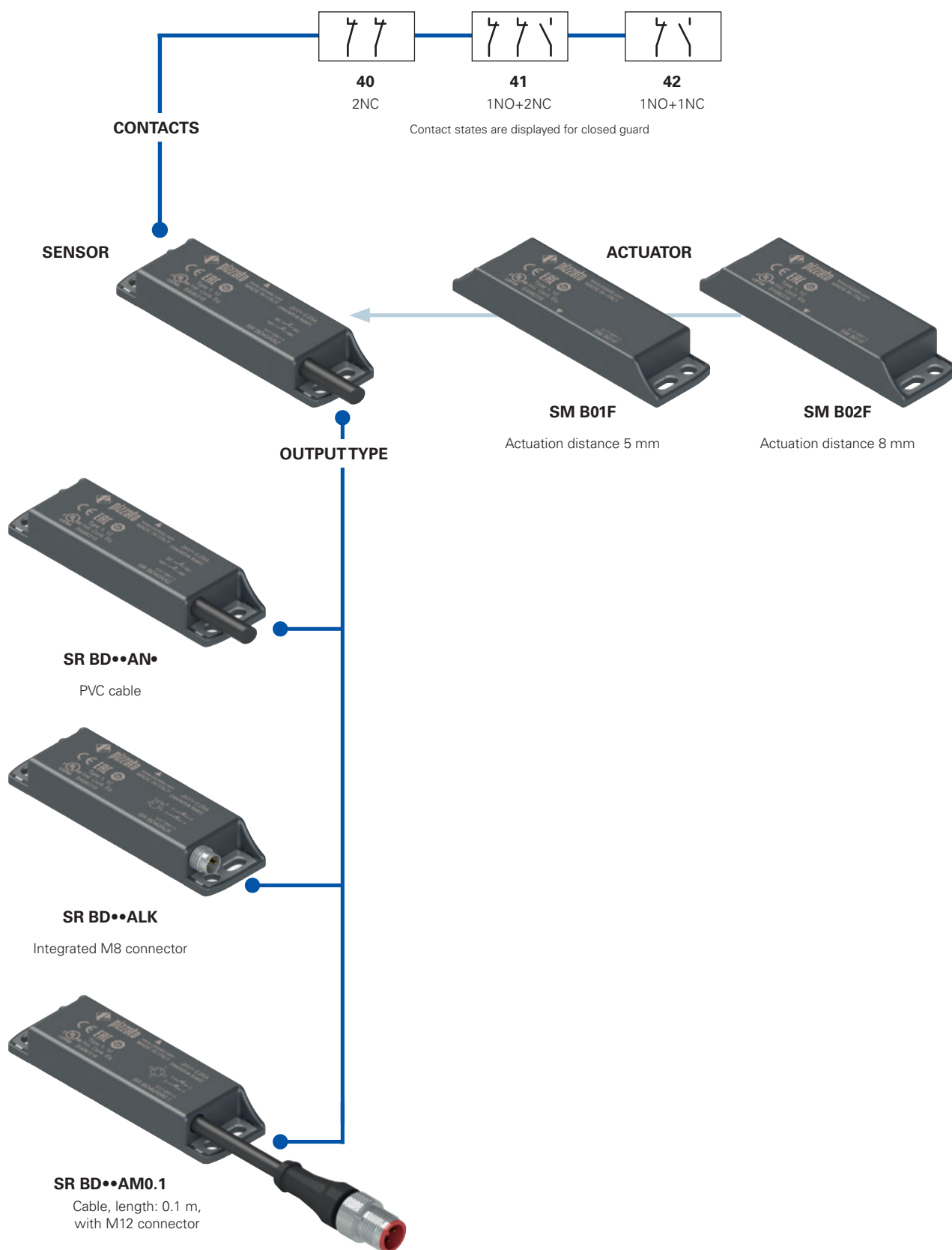

● product option
 → sold separately as accessory



Attention! The feasibility of a code number does not mean the effective availability of a product. Please contact our sales office.

Code structure for sensor with actuator

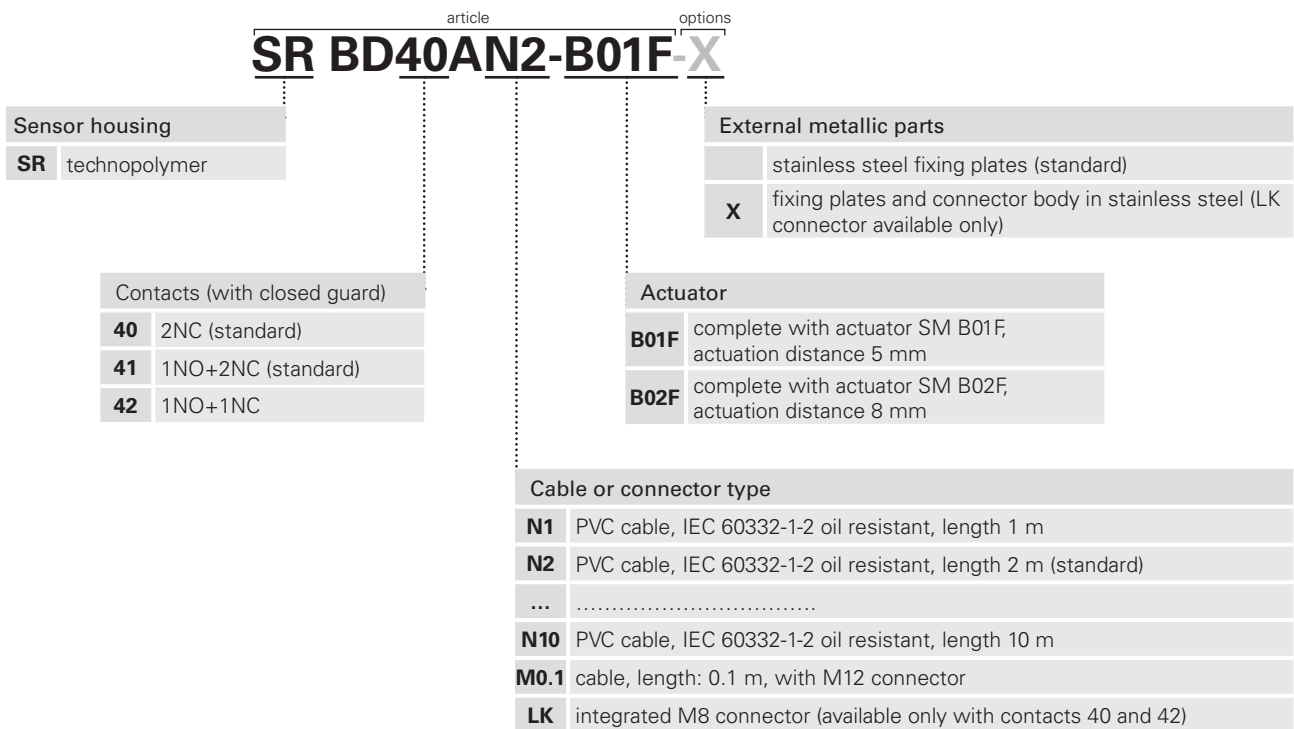

Attention! The feasibility of a code number does not mean the effective availability of a product. Please contact our sales office.

Code structure for single sensor

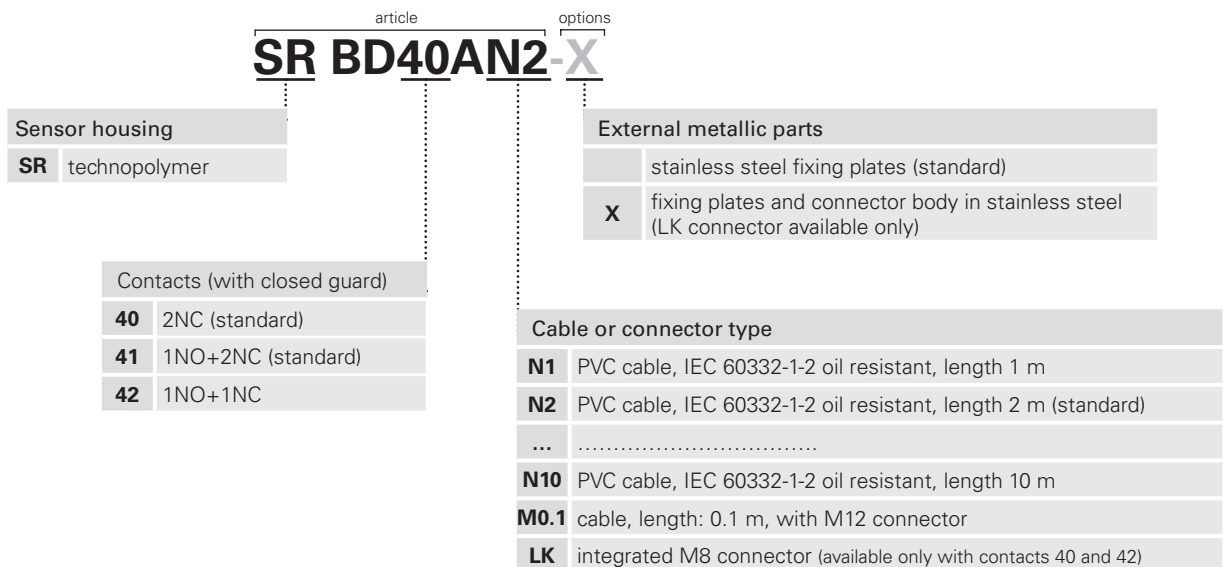

Attention! The feasibility of a code number does not mean the effective availability of a product. Please contact our sales office.

Code structure for single actuator

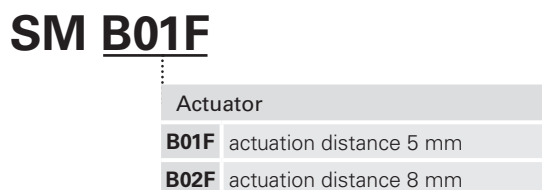



Main features

- Actuation without mechanical contact
- Stainless steel fixing plates
- Output contacts: 2NC, 1NO+2NC or 1NO+1NC
- Insensitive to dirt
- Protection degrees IP67 and IP69K
- Coded actuator
- Technopolymer housing
- Versions with M8 or M12 connector

Quality marks:



UL approval: E496318
 TÜV SÜD approval: Z10 18 05 75157 024
 EAC approval: RU C-IT.YT03.B.00035/19

Compliance with the requirements of:

Machinery Directive 2006/42/EC,
 EMC Directive 2014/30/EU,
 RoHS Directive 2011/65/EU.

Technical data

Housing

Housing made of glass fibre reinforced technopolymer, self-extinguishing.
 Versions with integrated cable 4 x 0.34 mm² or 6 x 0.25 mm², length 2 m, other lengths from 0.5 m ... 10 m on request.

Versions with integrated M8 connector

Versions with 0.1 m cable length and M12 connector, other lengths from 0.1 ... 3 m on request

Protection degree:

IP67 acc. to EN 60529

IP69K acc. to ISO 20653

(Protect the cables from direct high-pressure and high-temperature jets)

General data

SIL (SIL CL) up to:

SIL 3 acc. to EN 62061

Performance Level (PL) up to:

PL e acc. to EN ISO 13849-1

Safety category up to:

cat. 4 acc. to EN ISO 13849-1

Interlock, no contact, coded:

type 4 acc. to EN ISO 14119

Coding level:

low acc. to EN ISO 14119

Safety parameter B_{10D}:

20,000,000 (with compatible Pizzato Elettrica safety modules)

400,000 (at max. load: DC12 24 V 250 mA)

Mission time:

20 years

Ambient temperature:

-25°C ... +80°C

Ambient temp. with flexible installation cable:

-5°C ... +80°C

Vibration resistance:

10 gn (10 ... 150 Hz) acc. to IEC 60068-2-6

Shock resistance:

30 gn; 11 ms acc. to EN 60068-2-27

Pollution degree

3

Screw tightening torque:

0.8 ... 2 Nm

In compliance with standards:

IEC 60947-1, IEC 60947-5-1, IEC 60947-5-2, IEC 60947-5-3 (in connection with safety module), EN ISO 14119, EN ISO 12100, EN ISO 13849-1, EN ISO 13849-2, IEC 62061:2005, IEC 60204-1, IEC 60529, IEC 61508-1, IEC 61508-2, IEC 61508-4, EN 50581, ISO 20653, UL 508, CSA 22.2 No.14.

Approvals:

UL 508, CSA 22.2 No.14, EN ISO 13849-1, EN 60947-5-3, EN 50178, EN 61508-1, EN 61508-2, EN 61508-4, EN 62061, EN 60947-1.

Actuation data

Assured operating distance S_{ao}:

5 mm with actuator SM B01F

8 mm with actuator SM B02F

Assured release distance S_{ar}:

15 mm with actuator SM B01F

20 mm with actuator SM B02F

Repeat accuracy:

≤ 10%

Switching frequency:

up to 1 Hz

Distance between two sensors:

min. 50 mm

Electrical data

Rated operating voltage U_e:

24 Vac/dc

Rated operating current I_e:

0.25 A (resistive load)

Rated insulation voltage U_i:

120 Vac (with cable)

60 Vac / 75 Vdc (with M8 connector)

120 Vac (with M12 connector, 4-pole)

30 Vac / 36 Vdc (with M12 connector, 8-pole)

Rated impulse withstand voltage (U_{imp}):

6 kV

1.5 kV (with connector)

Thermal current I_{th}:

0.25 A

Maximum switching load:

6 W (resistive load)

Protection fuse:

0.25 A type F

Electrical endurance:

1 million operating cycles

⚠ If not expressly indicated in this chapter, for correct installation and utilization of all articles see the instructions given on pages 337 to 350.

Connection with safety modules for safety applications:

Connection with safety modules CS AR-01••••; CS AR-02••••; CS AR-04••••; CS AR-05••••; CS AR-06••••; CS AR-08••••; CS AR-46•024; CS AR-91••••; CS AT-0••••; CS AT-1••••; CS AT-3••••; CS FS-5••••; CS MF••••••; CS MP••••••.

When connected to the safety module, the sensor can be classified as a control circuit device up to PDF-M (EN 60947-5-3).

The system can be used in safety circuits up to PL e/SIL 3/category 4 in accordance with EN ISO 13849-1.

Features approved by UL

Electrical Ratings: 24 Vdc, 0,25 A (resistive load)

Environmental Ratings: Types 1, 4X, 6, 12, 13

Accessory for series SR for actuator switch series SM B.

Features approved by TÜV SÜD

Supply voltage: 24 Vac/dc

Rated operating current (max.): 0.25 A

Ambient temperature: -25°C ... +80°C

Protection degree: IP67

PL, category: PL e, cat. 4, with CS AR-08

In compliance with standards: 2006/42/EC Machinery Directive, EN ISO 13849-1:2015 (Cat. 4, PL e), EN 60947-5-3:2013, EN ISO 14119:2013, EN 61508-1:2010 (SIL 3), EN 61508-2:2010 (SIL 3), EN 61508-4:2010 (SIL 3), EN 62061:2005/A2:2015 (SIL CL 3)

Please contact our technical department for the list of approved products.

Please contact our technical department for the list of approved products.

Description



Coded magnetic sensors are devices suitable for monitoring protections and guards of machines without inertia which, when linked to a safety module, can create a system with safety category up to SIL 3 according to EN 62061, up to PL e according to EN ISO 13849-1 and up to category 4 according to EN ISO 13849-1.

These products consist of a sensor that detects the magnetic field and which is connected to the machine structure and of a coded magnetic actuator, which is connected to the movable guard. When the sensor and actuator are approached (closed guard), the sensor detects the actuator and actuates the electrical contacts. The sensor is designed to be activated only by the correct coded actuator and not through a common magnet.

Insensitivity to dirt

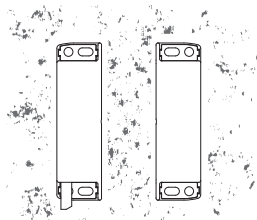

Magnetic sensors are totally sealed and retain their safety characteristics also where dirt and dust are present (not ferromagnetic material). This characteristic, combined with the design without recesses, makes them particularly suitable for use in the food industry.

Wide actuation range

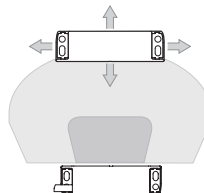

With their built-in features, magnetic sensors have a wide actuation range, making them very well suited for applications with large tolerances or where mechanical properties change over time.

In this type of sensor, the actuation distances may vary depending on the shift direction of the actuator in relation to the sensor.

Actuation from many directions

The coded magnetic sensors were designed to be activated by the respective actuator from various directions. The customer therefore enjoys maximum flexibility when positioning devices along the perimeter of the guards.

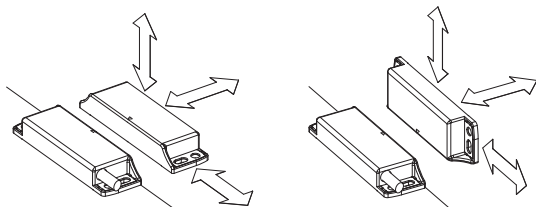

Stainless steel fixing plates

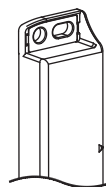

To prevent damage to the fixing slots when fastening on non-perfectly flat surfaces, coded magnetic sensors are equipped with stainless steel fixing plates. Even in the presence of suitable fixing surfaces, this solution makes the sensor more robust against mechanical stresses.

Assembly of multiple sensor-actuator systems

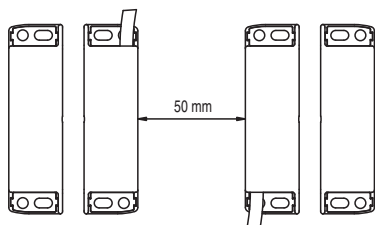

It is possible to install more than one device on the same machine. The minimum mounting distance between sensor-actuator systems is only 50 mm.

Safety screws for actuators

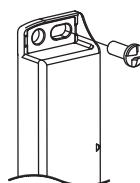

As required by EN ISO 14119, the actuator must be fixed immovably to the door frame. Pan head safety screws with one-way fitting are available for this purpose. With this screw type, the actuators cannot be removed or tampered by using common tools.

See accessories on page 332.

Laser engraving



All devices are marked using a dedicated indelible laser system. These engravings are therefore suitable for extreme environments too. Thanks to this system that does not use labels, the loss of plate data is prevented and a greater resistance of the marking is achieved over time.

Series connection of multiple sensors

The coded magnetic sensors can be connected in series with the only limitation that the overall resistance, of sensors and the related wiring, has to be not higher than the admitted max. value of the module, which typically is equal to 50 ohm (see module features). This is a very high value that, with normal wiring, allows the use of dozens of sensors without problems. It is also possible to realise mixed circuit solutions by connecting coded magnetic sensors in series to safety switches, with the only limitation being the above-mentioned maximum electrical resistance.

It should be noted that the series connection of two or more coded sensors reduces the self-monitoring capacity of the system, see ISO/TR 24119.

The use of Pizzato Elettrica safety modules is recommended.

Protection degrees IP67 and IP69K

IP69K
IP67

These devices are designed to be used in the toughest environmental conditions and they pass the IP67 immersion test acc. to EN 60529. They can therefore be used in all environments where maximum protection degree of the housing is required. Due to their special design, these devices are suitable for use in equipment subjected to cleaning with high pressure hot water jets. These devices meet the IP69K test requirements according to ISO 20653 (water jets with 100 bar and 80°C).

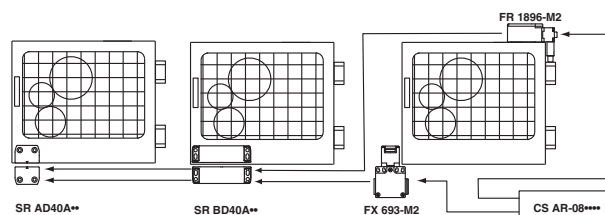

Internal connections with cable

Contact states are displayed for closed guard

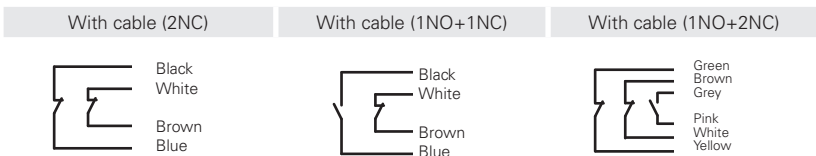

Internal connections with connector

Contact states are displayed for closed guard

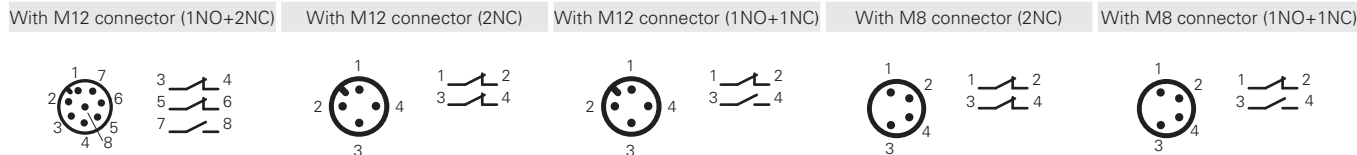

For female connectors, see page 321

Connection with safety modules

A coded magnetic sensor alone cannot be used for safety functions because its operating principles are not considered safe by the standards (e.g. positive opening on mechanical switches). For this reason, a magnetic sensor coded for use in safety applications must always be connected to a safety module that monitors its proper operation through a circuit with at least two channels.

Compatible safety modules

These magnetic sensors have been checked and tested for operation with suitable safety modules (see list).

The use of complete and tested solutions guarantees the electrical compatibility between the sensor and safety module, as well as high reliability.

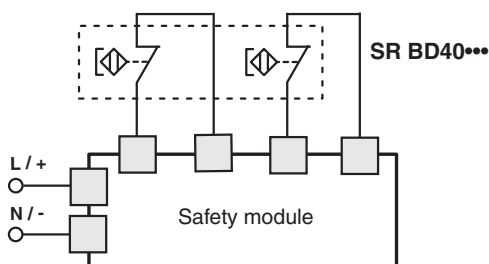

Sensors	Compatible safety modules	Safety module output contacts	
		Instantaneous contacts	Delayed contacts
SR BD40A... SR BD41A... SR BD42A... ^a	CS AR-01•••• ^b	2NO+1NC	/
	CS AR-02•••• ^b	3NO	/
	CS AR-04•••• ^b	3NO+1NC	/
	CS AR-05••••	3NO+1NC	/
	CS AR-06••••	3NO+1NC	/
	CS AR-08••••	2NO	/
	CS AR-46•024	1NO	/
	CS AR-91••••	2NO+1PNP	/
	CS AR-94••••	2NO	/
	CS AR-95••••	2NO	/
	CS AT-0•••••	2NO+1NO	2NO
	CS AT-1•••••	3NO	2NO
	CS AT-3•••••	2NO	1NO
	CS FS-5•••••	1NO+1NC+1CO	/
	CS MP••••••••	see page 277	see page 277
CS MF••••••••	see page 305	see page 305	

^a Compatible with CS MF202••-P4 and CS MP•••••••• only.

^b Compatible with modules with production batch later than 06/2014 only. For features of the safety modules see page 213.

Connection with safety modules CS AR-05 or CS AR-06

Input configuration with manual start (CS AR-05) and monitored start (CS AR-06)
2 channels

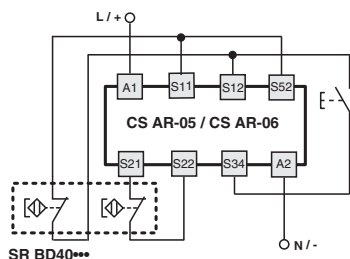

Connection with safety modules CS AR-08 or CS AT

Input configuration with manual start
2 channels

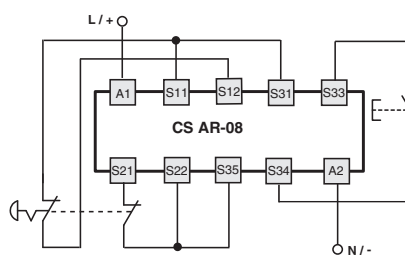

For features of the safety modules see page 213.



Operating distances SR BD.....-B01F

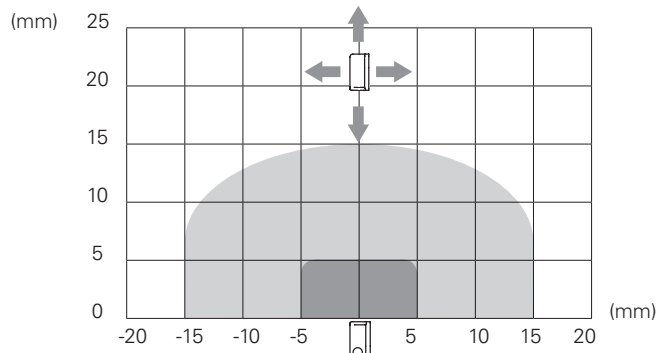
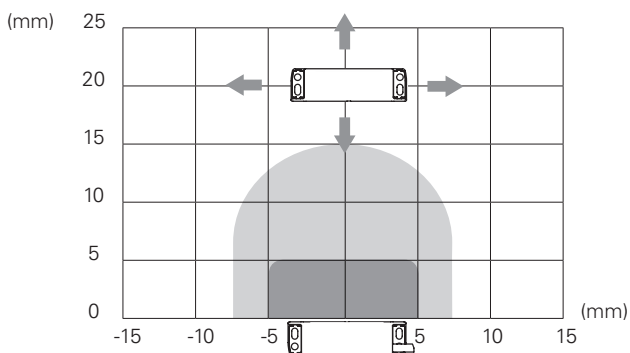

Operating distances SR BD.....-B02F

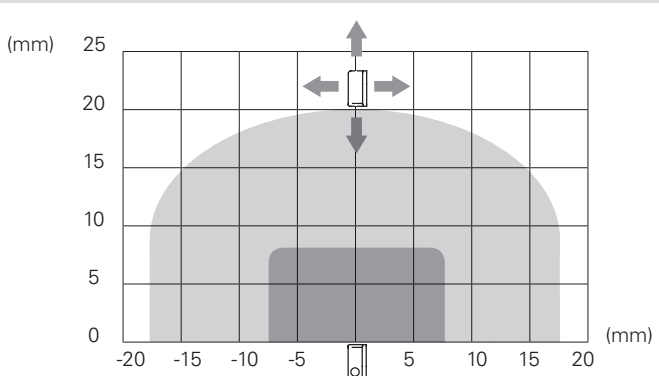
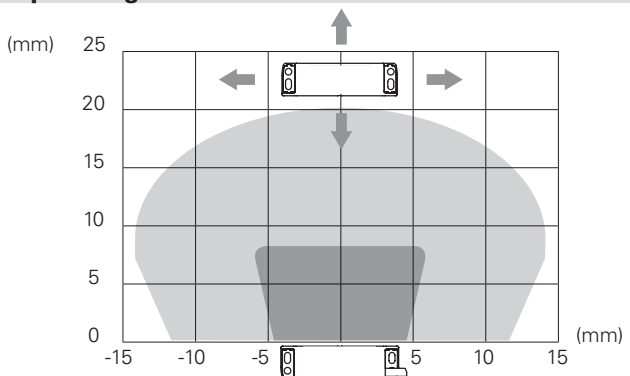

Legend:
 ■ Assured operating distance S_{ao} ■ Assured release distance S_{ar}
 Note: The progress of the activation areas is for reference only

Dimensional drawings

Integrated cable, length: 2 m		M8 connector		Cable, length: 0.1 m, with M12 connector		coded actuator Low level of coding acc. to EN ISO 14119	
SR BD40AN2	2NC	SR BD40ALK	2NC	SR BD40AM0.1	2NC	SM B01F	Actuation distance 5 mm
SR BD41AN2	1NO+2NC	/		SR BD41AM0.1	1NO+2NC	SM B02F	Actuation distance 8 mm
SR BD42AN2	1NO+1NC	SR BD42ALK	1NO+1NC	SR BD42AM0.1	1NO+1NC		

Accessories

Spacer

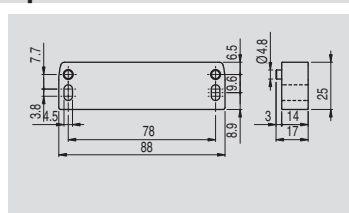

If possible do not mount the sensor and the actuator on ferromagnetic materials.
 This spacer is placed between the magnetic safety sensors and metal surfaces that can deflect the magnetic field: as a result, the activation and deactivation distances of the sensor remain the same.
 Because it is made out of a single block of material, it is especially well suited for applications where a high level of cleanliness is required, as any material present in the installation area cannot penetrate and accumulate.

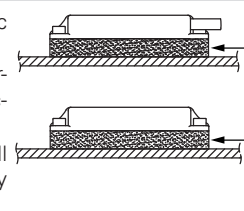

Spacer

Article	Description
VS SP1BA1	Spacer for SR B series sensors

All values in the drawings are in mm

Accessories See page 321

→ The 2D and 3D files are available at www.pizzato.com